

LD BOOK

2023 EDITION



Where **innovation** leads to **success**

TABLE OF CONTENTS

1.0 LDETEK

1.1 Company Profile	4
1.2 Global Locations	5

2.0 PRODUCTS

2.1 Detectors	9
Plasmatetek (PED) Series.....	9
2.2 Gas Chromatographs	23
Multidetek 3.....	23
Multidetek 3 EX.....	29
2.3 Online Analysers	33
LD8000 Series.....	33
LDSEnz.....	44
LDMOX.....	48
LD2000.....	53
2.4 Purifiers	57
LDP1000 Series.....	57
LDP2000 Series.....	60
LDCRYO.....	65
LDRPS.....	68
Moisture & Hydrocarbons Traps Series.....	71
2.5 System integration	75
LDrack and LDportable Solutions.....	75
2.6 Accessories	83
LDGSS - Ultra High Purity Gas Stream Selector.....	83
LDGM - Gas manifold panel for zero/span/sample gas switching.....	85
LDGDSA - Automatic Gas Dilution System.....	87
LDPMS - Pressure Monitoring System.....	89
LDASS - Automatic Switchover System.....	92
Line Pressure Regulators & Shut Off Valves.....	95
Fittings.....	102

3.0 APPLICATION NOTES

3.1 Environment	109
LD12-01 - Greenhouse analysis with the PlasmaDetek.....	110
LD15-03 - Measurement of part per billion N2O in air.....	113
LD16-01 - Air analysis using the MultiDetek2 and PlasmaDetek2.....	116
LD16-13 - Measurement of Greenhouse gases GHG.....	118
LD19-06 - VOCs measurement in the air.....	122
LD20-09 - Trace hydrocarbons (THCs/VOCs) with MultiDetek2 and FID.....	127
3.2 Industrial gas	135
LD12-02 - Analysis of permanent gases and light hydrocarbons with the PlasmaDetek.....	136
LD12-03 - Analysis of argon in pure oxygen with the PlasmaDetek and ArgoTek.....	138
LD12-04 - Analysis of nitrogen in hydrogen and oxygen bulk with the PlasmaDetek.....	140
LD12-06 - Increasing argon production with the MultiDetek.....	143
LD12-07 - Analysis of Neon-Hydrogen-Argon-Krypton-Nitrogen with the PlasmaDetek & the HSR-Etek column.....	145
LD12-09 - Hydrocarbons measurement for Oxygen production using PlasmaDetek & Multidetek-2.....	148
LD13-01 - Analysis of UHP Hydrogen production using Plasmatetek-2 & micro GC Multidetek-2.....	151
LD13-02 - Measurement of nitrogen in a mixture of Argon-Oxygen.....	154
LD14-01 - Light hydrocarbons measurement with the *PlasmaDetek-E system with nitrogen carrier gas and the MultiDetek-2.....	156
LD15-08 - Measurement of impurities in UHP helium using MultiDetek2 and PlasmaDetek2.....	160
LD16-02 - Analysis of hydrocarbons, CO2, N2O in Oxygen with MultiDetek2 system and the PlasmaDetek-E detection technology.....	164
LD16-06 - LD8000 MultiGas online gas analysis solution for high purity compressed Helium used in cryogenic installations.....	167
LD16-07 - Measurement of impurities in UHP Argon using the MultiDetek 2 and PlasmaDetek 2.....	169
LD16-08 - Measurement of hydrocarbons in UHP Oxygen using the MultiDetek 2 and PlasmaDetek-E.....	171
LD16-09 - Measurement of trace impurities in UHP Hydrogen.....	175
LD16-10 - Measurement of trace Ar-Kr and N2 in a bulk gas Oxygen.....	177
LD16-11 - Measurement of trace impurities in multiple bulk gases.....	179
LD19-05 - Trace impurities in UHP Argon for hot isostatic pressing (HIP) and additive manufacturing (AM) industries.....	187
LD20-04 - MultiDetek2 with PlasmaDetek2 configured as online analyser for fast Crude Argon analysis.....	192
LD20-06 - Measuring trace O2-N2-H2O for Lithium-Ion batteries inert atmosphere.....	194
LD21-01 - Trace impurities measurement for synthetic diamond "grows" by chemical vapor deposition (CVD).....	196
LD22-01 - Analysis of Krypton & Xenon in UHP Oxygen.....	202
LD23-01 - Analysis of trace impurities in UHP Helium.....	204
LD23-03 - Analysis of trace impurities in UHP Krypton.....	209
LD23-04 - Analysis of trace impurities in UHP Argon.....	213

TABLE OF CONTENTS

3.3 Petrochemical	217
LD12-08 - Analysis of Sulfurs with the PlasmaDetek	218
LD13-03 - Measurement of H ₂ S and COS in Syngas with MultiDetek 2	222
LD16-05 - Refinery gas analyses with MultiDetek2 compact gas chromatograph and PlasmaDetek2 gas detector	224
LD17-01 - Trace Hydrocarbons and Permanent gases in Propylene	228
3.4 Agriculture	231
LD15-01 - Measurement of hydrocarbons, including the organic hormone (Ethylene) in CO ₂ production with MultiDetek-2 and PlasmaDetek-E	232
3.5 Electronic gases & semiconductor	235
LD15-02 - Measurement of part per billion Ar and N ₂ in oxygen for semiconductor industry	236
LD15-04 - Measurement of silane purity in electronic gases industry	240
LD18-01 - Measurement of trace impurities in Germane (GeH ₄) for electronic gas industry using PlasmaDetek2 and MultiDetek2	243
LD19-02 - Measurement of trace impurities in high purity Nitrogen trifluoride (NF ₃) for electronic gas industry	247
LD19-03 - Measurement of trace impurities in high purity nitrous oxide (N ₂ O) for electronic gas industry	251
LD20-03 - MultiDetek2 gas chromatograph with PlasmaDetek2 detector for analysis of semiconductor specialty gases as UHP C ₄ F ₈	257
LD20-07 - Measurement of ppt for semiconductor H ₂ -CO ₂ -NMHC-N ₂ -CO-CH ₄ in UHP gases	259
LD21-02 - Analysis of trace impurities in UHP F ₂ -Cl ₂ and WF ₆ used for semiconductor industry	265
LD22-03 - Analysis of sub ppb trace impurities in UHP Oxygen	270
LD23-05 - Turnkey solution for ASU gas producers and SEMI applications	274
3.6 Natural gas	277
LD15-09 - Measurement of THT in natural gas using MultiDetek2 and PlasmaDetek2	278
LD19-01 - Measurement of THT-TBM odorants in natural gas	281
LD19-04 - Measurement of sulfurs & mercaptans combined with THT-TBM in natural gas	286
3.7 Energy	291
LD16-04 - Sulfur Hexafluoride (SF ₆) purity analysis using the MultiDetek 2 and PlasmaDetek 2	292
LD22-02 - Measurement of trace impurities in UHP hydrogen for fuel cells with the HyDetek system solution	295
3.8 Food and Beverage	327
LD16-12 - Trace impurities in Carbon Dioxide for beverage and food packaging industry	328
LD17-02 - Gas analysis for wineries	334
LD17-04 - Trace impurities in Carbon Dioxide for beverage and food packaging industry	336
LD23-02 - Analysis of trace impurities in UHP Carbon Dioxide	340
3.9 Pharmaceutical and Medical	347
LD20-01 - MultiDetek2 uses for medical & pharmaceutical applications	348
3.10 Electronic Special Gases	353
LD20-02 - MultiDetek2 gas chromatograph with PlasmaDetek2 detector for hydrogen isotopes separation and impurities in Deuterium	354
LD20-05 - MultiDetek2 with PlasmaDetek2 & TCD detectors uses for the analysis of purity Xenon-Krypton-Neon	356
LD21-03 - Analysis of trace impurities in UHP B ₂ H ₆ used for semiconductor industry	364
3.11 Design Reports	367
LD8000 - Design report	368
LD12-05 - Design report	376
LD2000 - Design report	380
Trace moisture analysis - Design report	385
LD8000-Multigas - Design report - Configured for cryogenic Helium application	393
LD20-01 - Design report - Compact stream selector system	401
LD8000+ - Design report	405

4.0 TESTIMONIALS

4.1 LDT-01 - Analysis of permanent gases in different matrix using PlasmaDetek mounted on a Perkin Elmer GC	412
4.2 LDT-02 - Analysis of trace impurities in different gas matrix using PlasmaDetek mounted on Agilent 7890 GC	413
4.3 LDT-03 - Analysis of impurities in Argon using PlasmaDetek2 mounted on a GAS Compact GC	414
4.4 LDT-04 - PlasmaDetek solutions mounted on Perkin Elmer GC	415
4.5 LDT-05 - Analysis of trace impurities in electronic grade hydrogen using PlasmaDetek2 mounted on Agilent 6890 GC	416
4.6 LDT-06 - Analysis of hydrocarbons using PlasmaDetek2 mounted on DANI Master GC	417
4.7 LDT-07 - Trace N₂O analysis for greenhouse application using PlasmaDetek2 mounted on Agilent 7890 GC	419
4.8 LDT-08 - Multidetek2 solutions for the energy market	420
4.9 LDT-09 - Application of PlasmaDetek in Determination of Trace Neon in High Purity Helium	421

5.0 CHROMATOGRAMS

5.1 Impurities	426
5.2 Samples	442



LDETEK COMPANY PROFILE

LDetek is a Canadian based company specialized in manufacturing, developing and integrating online gas analyzers, gas chromatograph systems and related accessories. Our mission is to provide reliable and performing systems with the best technology on the market.

With its commitment for continuous improvement, LDetek thinking and its members always aim to push the technology limit further. It brings innovative products and solutions to a market in a severe need of new and better quality material. The wide range of products, applications and patents developed, make LDetek portfolio attractive to many different areas of gas analysis activities. With a constant objective of offering quality products, LDetek always make all effort to get rigorous quality control and all necessary level of approbation and/or certification.

Our products and services are provided by a team of specialists with a strong experience in gas analysis business.

With a well established network of offices and partners in over 30 countries, a complete and pro active worldwide support is provided.

LDETEK, WHERE INNOVATION LEADS TO SUCCESS



ENVIRONMENT



INDUSTRIAL GAS



PETROCHEMICAL



AGRICULTURE



ELECTRONIC GASES & SEMICONDUCTOR



NATURAL GAS



HYDROCARBONS PROCESSING



FOOD AND BEVERAGE



PHARMACEUTICAL AND MEDICINE



ELECTRONIC SPECIAL GASES



HEALTH AND SAFETY



ENERGY

GLOBAL LOCATIONS

CANADA - LDETEK

LDetek Inc.

990 Rue Monfette Est, Thetford Mines, Québec, Canada G6G 7K6
+1 418 755 1319
info@ldetek.com

CHINA - LDETEK

LDetek China

Left section, second floor, Building B of Dachen science park, No. 10
Jingyuanjie road, Daxing district, Beijing.
+ 86 01 87246220
lwy@ldetekchina.com

UNITED STATES

Rotronic Instruments Corporation Inc

135 Engineers Rd, Hauppauge, NY 11788, United States
+1 631-427-3898
us.sales@processsensing.com

UNITED KINGDOM

Michell Instruments UK

48 Lancaster Way Business Park Ely, Cambridgeshire, CB6 3NW
+44 1353 658 000
uk.info@michell.com

IRELAND

Ntron Gas Measurement Ltd.

Mullaghboy Ind. Park, Navan, Co. Meath, C15 VFP2, Ireland
+353 46 907 1333
info@ntron.com

SWITZERLAND

Rotronic AG

Grindelstrasse 6, 8303 Bassersdorf, Switzerland
+41 44 838 11 11
measure@rotronic.ch

GERMANY

Michell Instruments GmbH

Max-Planck-Str. 14, Friedrichsdorf, 61381, Germany
+49 6172 5917-0
de.info@michell.com

ITALY

Michell Italia Srl

Via Magenta 77, Edificio 6, RHO, Milan, 20017, Italy
+39 02 4047194
it.info@michell.com

FRANCE

Michell Instruments SAS

1, Rue Monseigneur Ancel, Bâtiment C, Saint Priest, 69800, France
+33 43753 8820
fr.info@michell.com

BELGIUM, LUXEMBOURG, NETHERLANDS

Michell Instruments B.V.

Krombraak 11, Oosterhout, 4906 CR, The Netherlands
+31 162 680 471
nl.info@michell.com

SOUTH AMERICA

Michell Instruments Brasil Ltda

Av. Henrique Valadares, 69, Loja C - Centro, Rio de Janeiro, RJ,
20231-030, Brasil
+55 21 3852 7831

JAPAN

Michell Japan

Musashino Center Building, 1-19-18 Nakacho, Musashino, Tokyo,
180-0006, Japan
+81 422 502 600
info@michell-japan.co.jp

SINGAPORE

Rotronic Instrument PTE LTD

1003 Bukit Merah Central, #06-31 Inno Centre, Singapore 159836
+65 637 62 107
info@rotronic.sg

PAKISTAN, SRI LANKA, MALAYSIA AND SINGAPORE

Export Sales - Balaji Ramadurai

+971552226420
Balaji.Ramadurai@processsensing.com

ASIA PACIFIC EXCL. MALAYSIA AND SINGAPORE

Export Sales - Eric Tan

+82-10-6365 9992
Eric.Tan@processsensing.com

SOUTH KOREA

Export Sales - Eric Tan

+82-10-6365 9992
Eric.tan@processsensing.com

AUSTRALIA & NEW ZELAND

Export Sales - Sinna Sinnathura

+65 637 62 107
Sinna.Sinnathura@processsensing.com

THE MIDDLE EAST EXCL. SAUDI ARABIA, QATAR

Export Sales - Balaji Ramadurai

+971552226420
Balaji.Ramadurai@processsensing.com

THE MIDDLE EAST - SAUDI ARABIA, QATAR

Export Sales - Kartik Parikh

+971582356247
Kartik.Parikh@michell.com

2.0 PRODUCTS

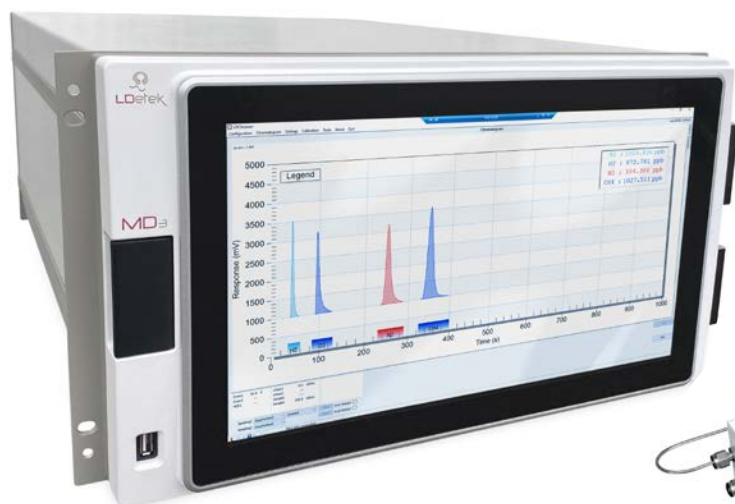

**Gas Chromatograph
and Detectors**



Online Analysers

Gas Purification

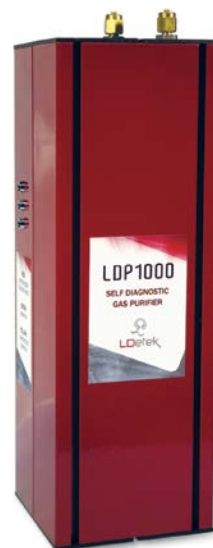

Dilution System



Accessories for Gas Chromatography



Stream selectors



Cabinet Integration



Engineering Support

PlasmaDetek



PLASMA EMISSION DETECTOR SYSTEM FOR GAS CHROMATOGRAPH

This plasma emission detector gives the opportunity to any system integrator or GC manufacturer to integrate a plug and play philosophy detector system. With its unique design, the PlasmaDetek allows to do new techniques and existing analysis configuration based on simplicity. PPB to % analysis can be done with capillary or packed columns. With the choice of argon or helium as carrier gas, combined with the selectivity configuration, the chromatography becomes easier.



FEATURES:

- Argon or helium carrier gas
- 4 in 1 detector
- Selective and non-selective configuration
- Wide range of applications
- Easy to interface with any GC and analyzer design
- PPB to % detection
- Very stable signal
- Maintenance free
- Fast installation and tune up
- Intelligent version based on DSP platform
- Low noise detector

APPLICATIONS:

- Laboratory and industrial gas chromatograph
- High purity gases
- Permanent gases
- Noble and rare gases
- Petrochemical and Hydrocarbon Processing
- Air analysis
- Environmental
- Energy industries
- Greenhouse application
- Etc...

Other gas analysis possible, please contact factory.

SPECIFICATIONS:

CARRIER GAS	Argon and Helium
POWER	80 to 240 VAC, 50-60 Hz
GAS CONNECTIONS	1/16" (can be customized)
OPERATION OUTLET PRESSURE	Atmospheric or Vacuum
OPERATING TEMPERATURE	10 °C to 50 °C (in stable environment)
FILTER	10u SS particle filter on the gas inlet
DETECTOR SIGNAL OUTPUT CONNECTION	BNC Coaxial type (can be customized)
POWER CONSUMPTION	Max 10 Watts
OUTPUT VOLTAGE	0-5 Volts (can be customized)

PRINCIPLE OF PLASMA EMISSION DETECTOR (PED):

The PED is a quartz cell with a unique design submitted to a high intensity and frequency electromagnetic field.

The principle based on spectroscopic emission cell is not a new technique, but the characteristics of the Plasma-Detek system that make it stable and efficient are the frequency, the intensity as well as the mechanical and electro- des design.

A luminous phenomenon, called electroluminescence, is created and is used as emission technique to quantify analytes.

When the carrier gas is ionized, spectral lines are emitted and detected by an optical system including filter and photo-diode. The emission varies for each substance that is brought along with the carrier gas.

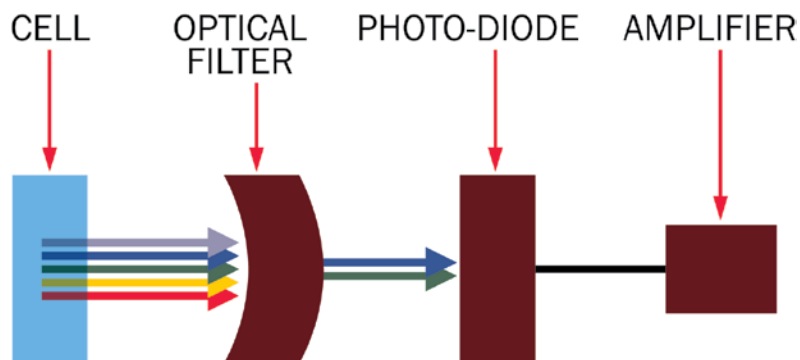
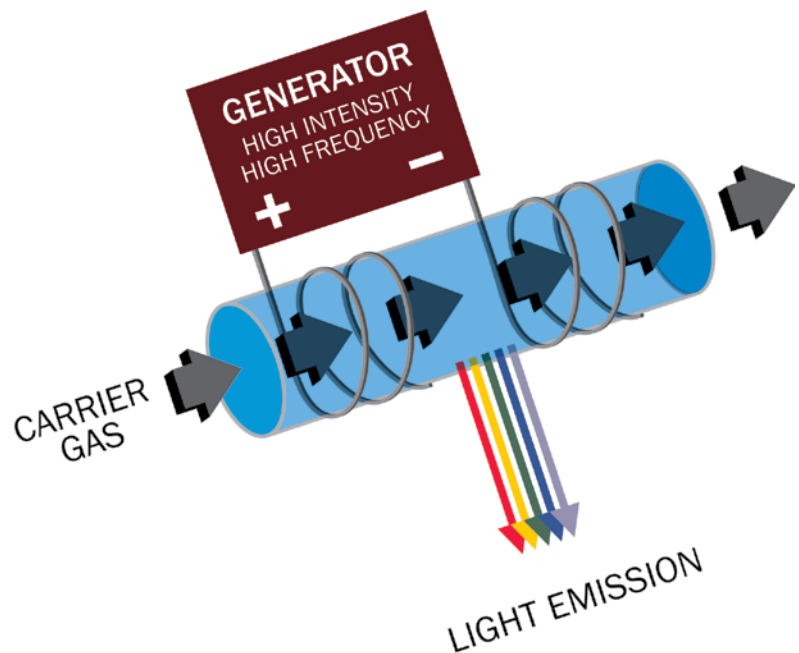

SELECTIVITY:

The selective configuration gives the possibility to be more sensitive on some impurities to make the chromatography easier and get better results. No need to add a supporting gas or other devices. The specific optical filter system is chosen for the application desired.

By having such selectivity, you can reduce analysis time and make fast chromatography. In some cases, consumables such as traps can be avoided. It becomes a cost effective solution, maintenance free system and can give better limit of detection by reducing residual background effect.

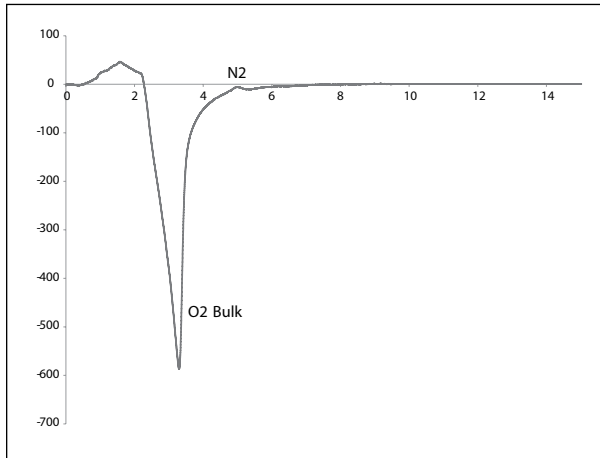

Figure 1: 1 ppm N2 in pure O2 with non-selective detector system

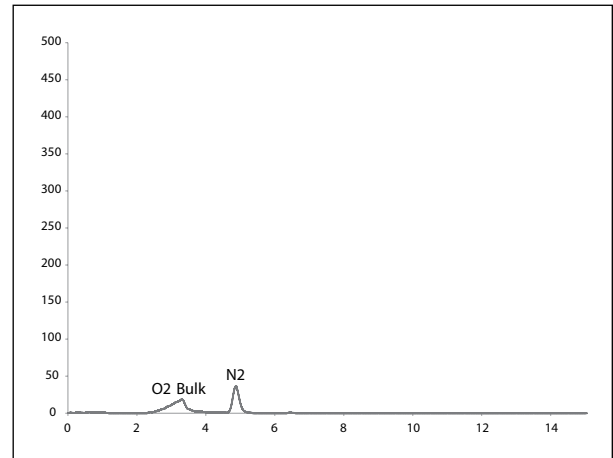
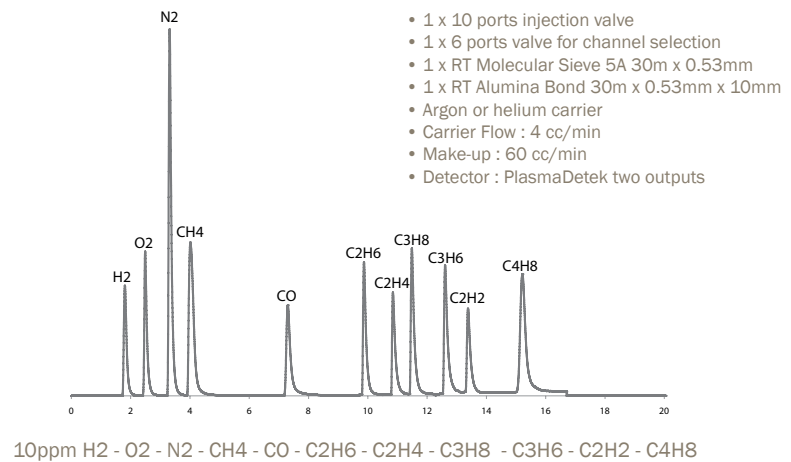

Figure 2: 1 ppm N2 in pure O2 with PlasmaDetek N2 selective configuration

ALL IN ONE DETECTOR:

The PlasmaDetek can replace many detectors and get all measurements with only one module. No need of doping gas, fuel or other support devices. Measuring permanent gases and light hydrocarbons have never been so easy. Many other gases can be detected, please contact LDetek for more information.



ARGON AND HELIUM CARRIER GAS:

Having the choice of argon or helium as carrier gas brings the advantage of making easier chromatography configuration. Argon can be cost effective compared to helium in some cases.

Good sensitivity is also obtained with both carriers giving the possibility to work from ppb to % application.

PLASMADETEK²



INTELLIGENT PLASMA EMISSION DETECTOR SYSTEM FOR GAS CHROMATOGRAPH



This microprocessor based plasma emission detector system gives all the tools to the GC integrator, manufacturer and user to integrate a plug and play detection system. With its customizable configuration capability, a detector has never been so intelligent.

IN A GLANCE:

- Argon or helium carrier gas
- No dead volume design
- All in one detector by replacing existing technologies commonly used
- Selective and non-selective configuration
- Analog or digital interface
- Wide range of applications
- Easy to interface with any GC and analyzer design
- PPB to % detection
- Very stable signal
- Maintenance free
- Fast installation and tune up
- Configuration software
- Possibility of customizable protocol to control the device
- Detect organic and inorganic compounds, permanent gases and noble gases (including Ne)

DOPING AGENT INJECTOR TEMPERATURE CONTROLLED

By controlling the temperature of the doping agent injection device, better stability of the measurement is achieved. The temperature is controlled by the PlasmaDetek controller and can be adjusted for the specific application. The use of different doping agents is application dependant is part of the selectivity mode.

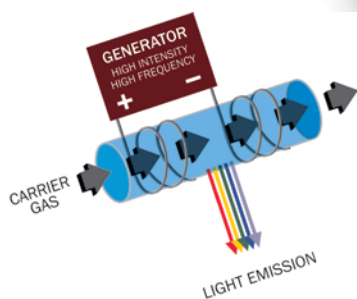
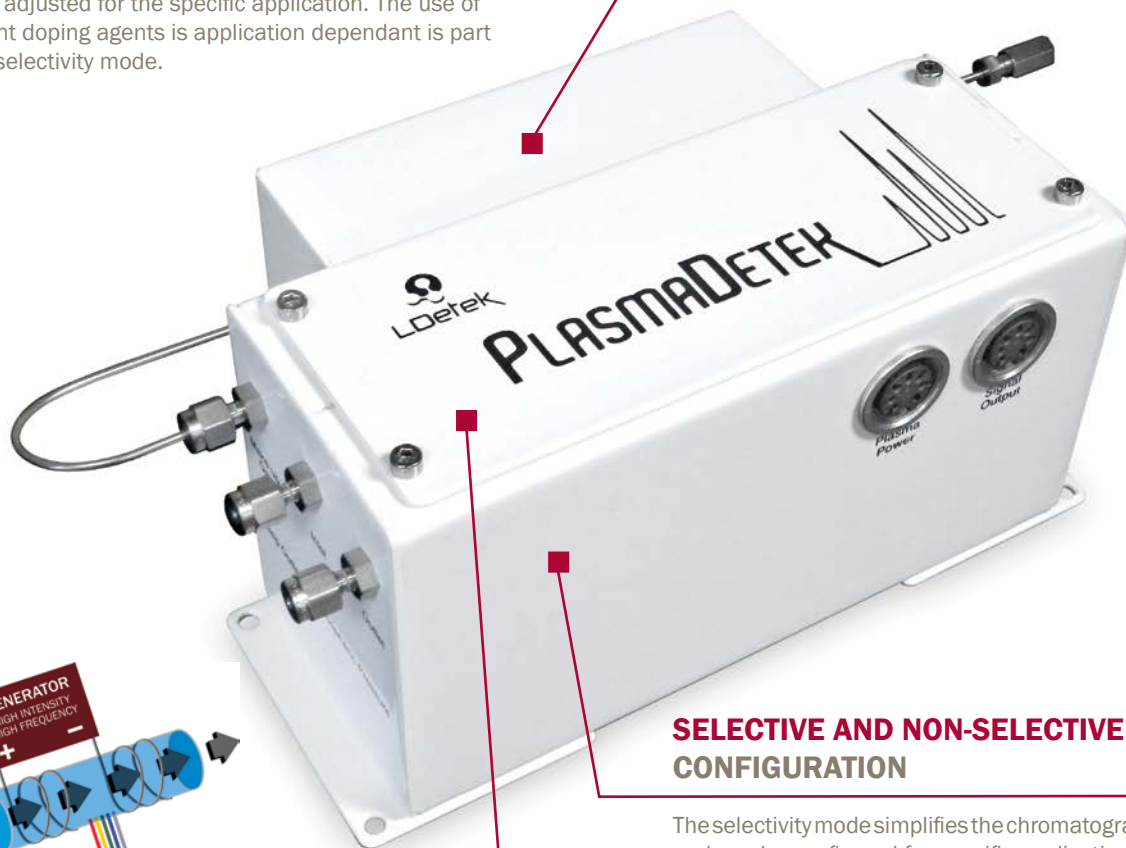

SELECTIVE AND NON-SELECTIVE CONFIGURATION

The selectivity mode simplifies the chromatography and can be configured for specific application.

PED DESIGN WITH NO DEAD VOLUME

The PlasmaDetek design avoids the creation of phantom peaks that occurs in conventional ionization detector. Its unique design made of a monolithic quartz makes the detector dead volume free. It is not affected by pressure or flow swings.

Conventional ionization detector

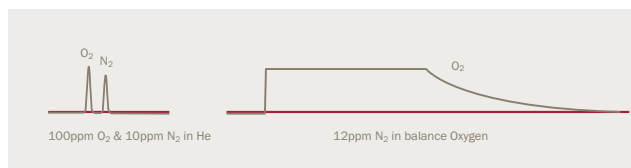

Plasmadetek

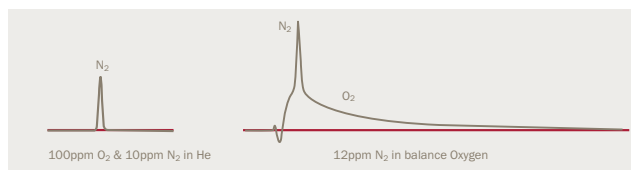

MICROPROCESSOR BASED CONTROLLER

With an integrated DSP, the signal can be processed to improve measurement as well as providing desired signal for any GC. Configurable with LDetek plasma configurator provided with each PlasmaDetek. Cost saving by having no electrometer needed to acquire the signal. Multiple stage of amplification integrated to achieve low to high concentration.

2 ANALOG OUTPUTS AS STANDARD

Both analog output can be used in parallel to interface with the desired signal acquisition system. Coaxial cables are provided with detector.

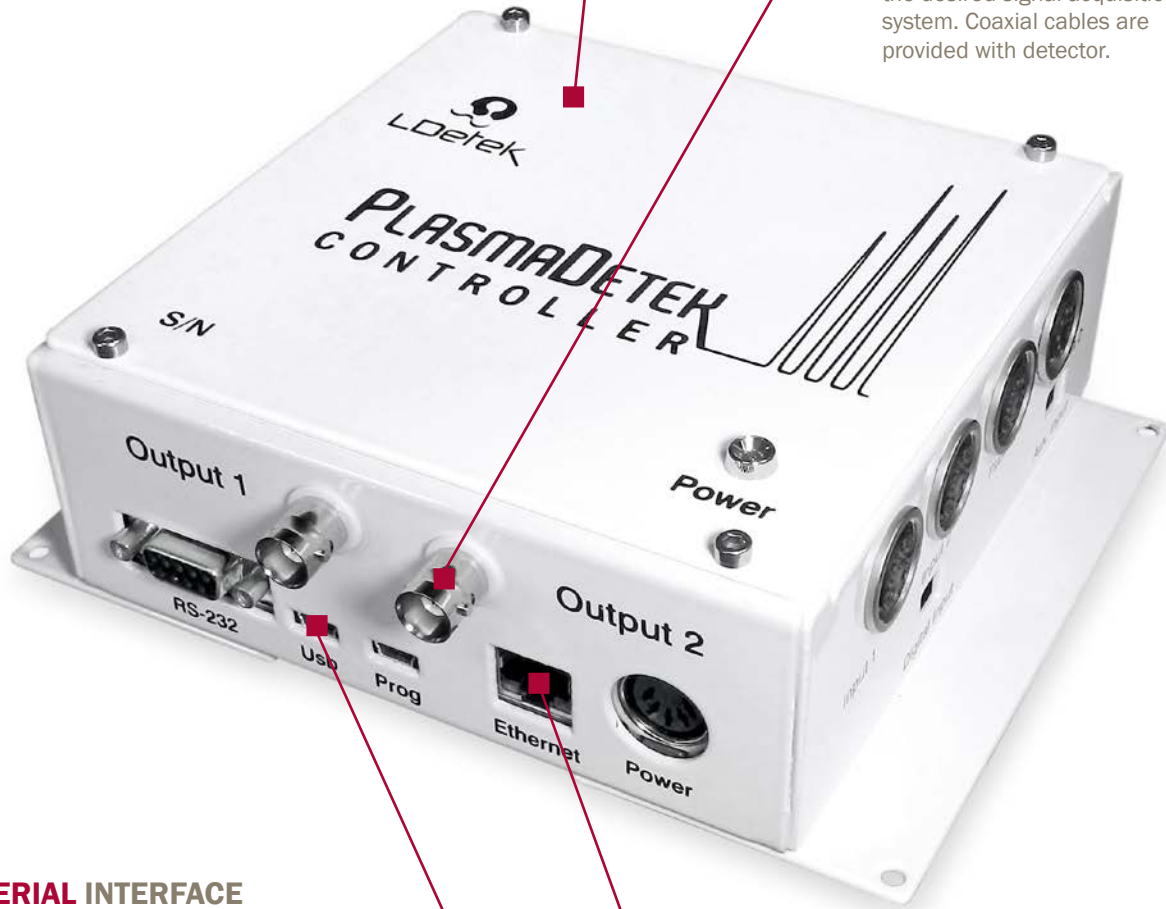

SERIAL INTERFACE

USB and RS-232 connection are available to provide digital signal and avoid analog interface. Custom digital communication can also be implemented to communicate and configure the PlasmaDetek from your own system.

ETHERNET PORT

Connect the PlasmaDetek to your network to communicate with the device.

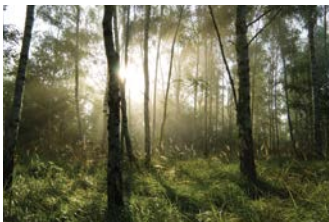

SPECIFICATIONS:

CARRIER GAS	Argon and Helium
POWER	80 to 240 VAC, 50-60 Hz
GAS CONNECTIONS	1/16" (can be customized)
OPERATION OUTLET PRESSURE	Atmospheric or Vacuum
OPERATING TEMPERATURE	10 °C to 50 °C (in stable environment)
FILTER	10u SS particle filter on the gas inlet
DETECTOR SIGNAL OUTPUT CONNECTION	BNC Coaxial type (can be customized)
POWER CONSUMPTION	Max 10 Watts

PLASMADETEK CONFIGURATOR:

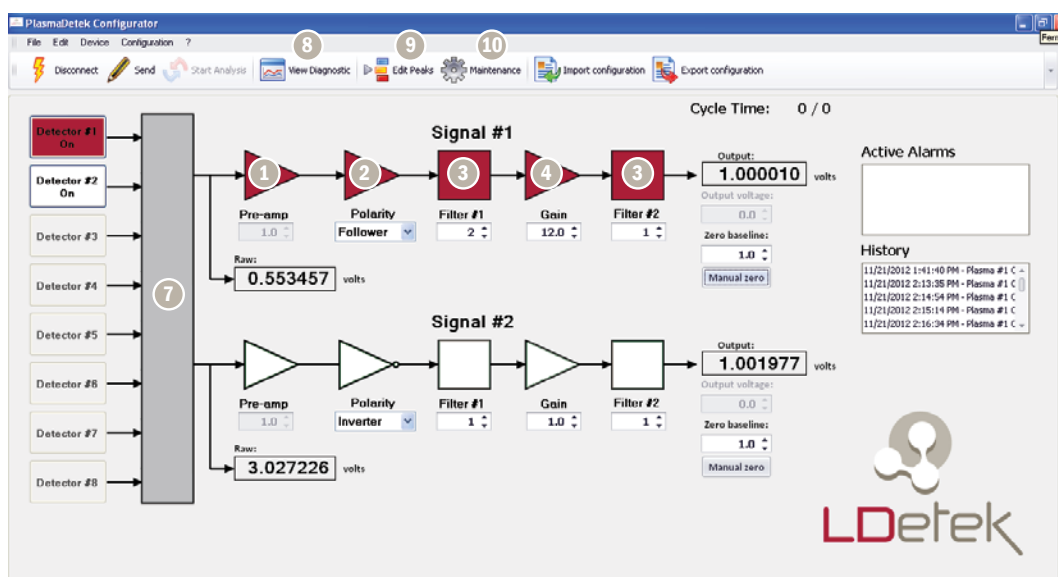

- 1 Adjust the amplification directly on the source light of the plasma to change the measurement scale of the detector. PPB to % application can be achieved with the same detector.
- 2 **SIGNAL POLARITY:** negative peaks can now be inverted to get positive peaks.
- 3 **FILTERING:** Digital filtering can be applied to improve signal provided to the GC.
- 4 **GAIN:** adjust the gain of the signal for the specific measurement.
- 5 **OUTPUT VOLTAGE:** set the output voltage scale that fits to the GC signal acquisition system.
- 6 **ZERO BASELINE:** set and perform zero baseline directly in the detector.
- 7 Connect up to 8 detector to the same plasma controller.
- 8 **DIAGNOSTIC TOOL:** Graphic tool to trend the raw or the output voltage.
- 9 **PEAK TABLE:** edit a peak event table to change all possible parameters at specific time analysis can be started manually or by digitally and the detector will follow your specific configuration.
- 10 Maintenance menu: all tools to troubleshoot the detector is provided.

PLASMADETEK₃



HEATED CAPABLE MICRO PLASMA EMISSION DETECTOR WITH INTERCHANGEABLE OPTICS



Patented



Flexible plasma emission detector for gas chromatograph. The ideal gas detector for ppb/ppm trace impurities in different gas matrix. The modular philosophy of this detector makes it suitable for lab operations as well as industrial applications.

FEATURES:

- Stand alone detector for any GC
- Heating up to 200 Celsius
- Up to 4 removable/changeable optical filters for a more flexible detector
- Changeable plasma cell
- Possibility to connect a spectrometer fiber optic direct on the cell for specific lab or research project
- Compatible with the PlasmaDetek 2 controller which makes it compatible with any previous installation
- Compatible with Clarity from DataApex
- Ideal for ppb/ppm trace impurities
- Replace ECD-FID-TCD-DID all in one detector
- Compatible with Helium, Argon, Nitrogen as carrier gas
- Selective, sensitive and generic configurable
- Quick switchable carrier gas type

Four changeable optical filters that offers flexibility. It can be changed anytime within seconds to adapt the analysis needs. It becomes possible to switch the application easily to find selectivity and sensitivity desired. The light collection system has been optimized to avoid light collection response loss by high temperature operation.



Heated capable housing up to 200 Celsius extending the application possibilities.

With its interchangeable quartz plasma cell module design, it becomes possible to do the maintenance on the detector. The application can be modified easily as well. The detector module design makes it easy to replace or change any component without damaging or creating leaks. The design offers an integrated leak detector to auto diagnostic the carrier gas and make up leak rate.



MICROPROCESSOR BASED CONTROLLER

With an integrated DSP, the signal can be processed to improve measurement as well as providing desired signal for any GC. The parameters can easily be changed with the use of the LDetek configurator software interface that comes with each PlasmaDetek detector. Cost saving by having no electrometer needed to acquire the signal. Multiple stage of amplification integrated to achieve low to high concentration.

2 ANALOG OUTPUTS AS STANDARD

Both analog output can be used in parallel to interface with the desired signal acquisition system. Coaxial cables are provided with detector.

MULTIPLE I/Os

Multiple I/Os are available on the controller module to extend the application capabilities. It becomes possible to use the controller to acquire signal from other devices or detectors. It is also possible to control different devices as valves actuation, ovens or other components.

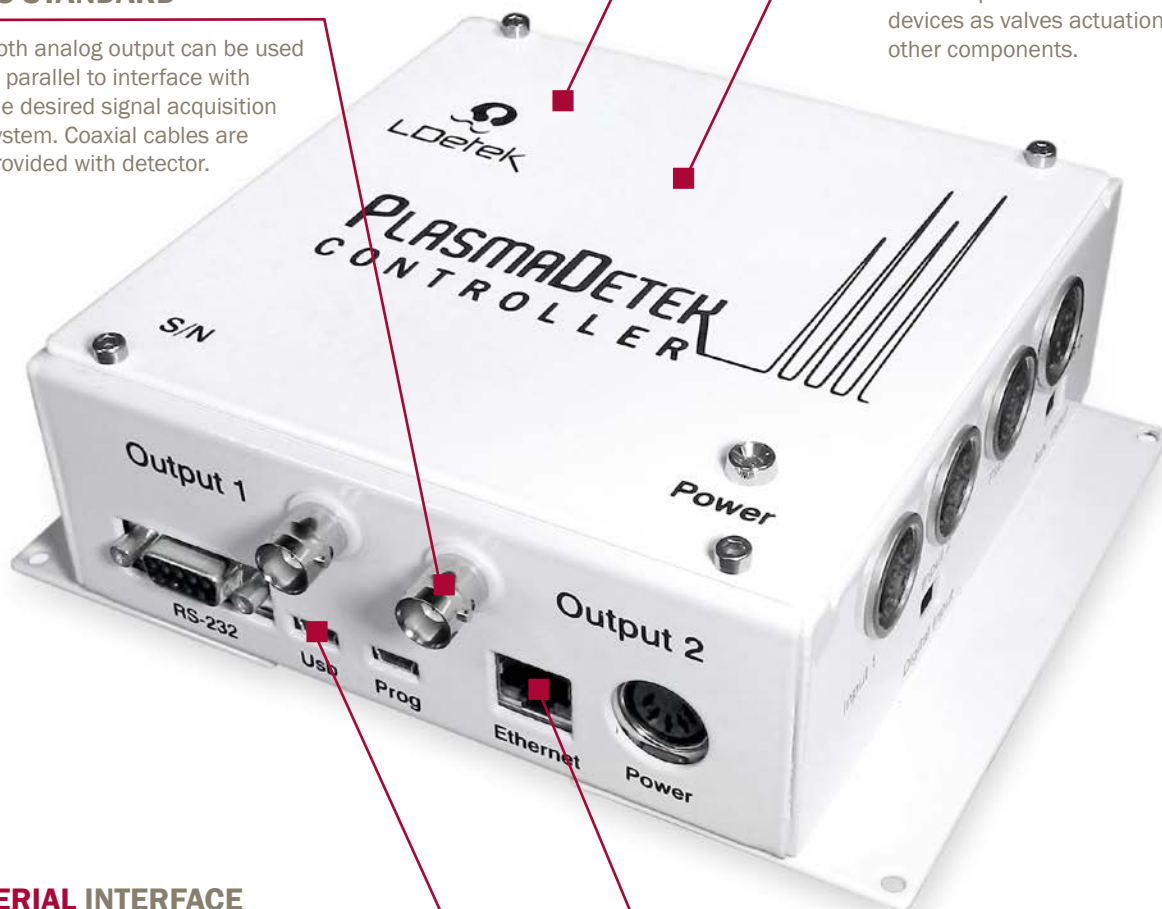

SERIAL INTERFACE

USB and RS-232 connection are available to provide digital signal and avoid analog interface. Custom digital communication can also be implemented to communicate and configure the PlasmaDetek from your own system.

ETHERNET PORT

Connect the PlasmaDetek to your network to communicate with the device.

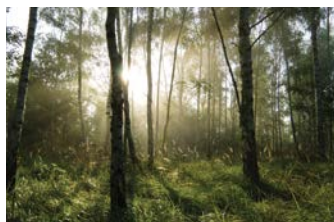

SPECIFICATIONS:

CARRIER GAS	Argon, Helium, Nitrogen
POWER	80 to 240 VAC, 50-60 Hz
GAS CONNECTIONS	1/16" (can be customized)
OPERATION OUTLET PRESSURE	Atmospheric or Vacuum
OPERATING TEMPERATURE	10°C to 200°C
FILTER	10u SS particle filter on the gas inlet
DETECTOR SIGNAL OUTPUT CONNECTION	BNC Coaxial type (can be customized)

PLASMADETEK CONFIGURATOR:

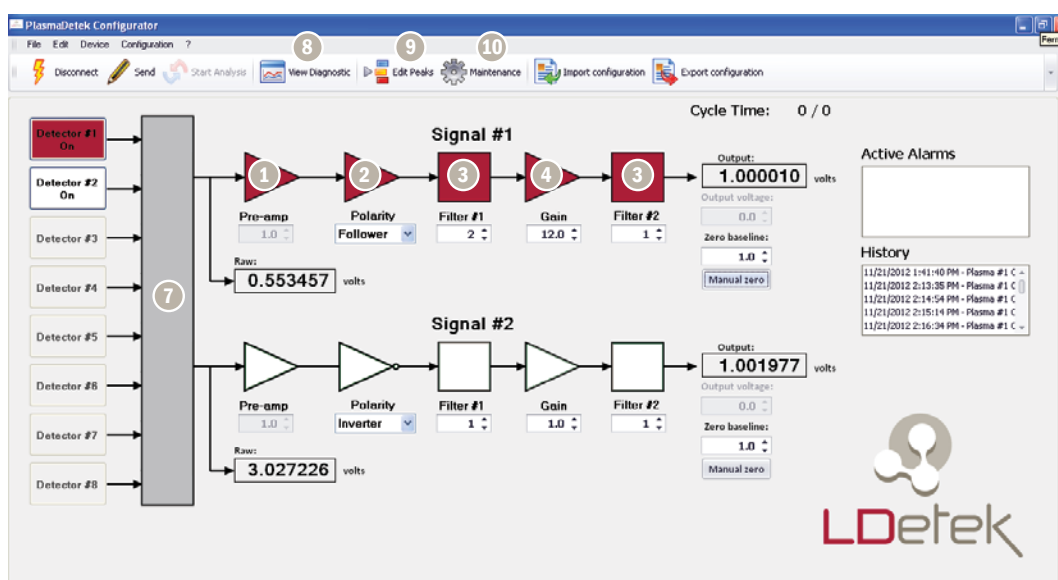

- 1 Adjust the amplification directly on the source light of the plasma to change the measurement scale of the detector. PPB to % application can be achieved with the same detector.
- 2 **SIGNAL POLARITY:** negative peaks can now be inverted to get positive peaks.
- 3 **FILTERING:** Digital filtering can be applied to improve signal provided to the GC.
- 4 **GAIN:** adjust the gain of the signal for the specific measurement.
- 5 **OUTPUT VOLTAGE:** set the output voltage scale that fits to the GC signal acquisition system.
- 6 **ZERO BASELINE:** set and perform zero baseline directly in the detector.
- 7 Connect up to 8 detector to the same plasma controller.
- 8 **DIAGNOSTIC TOOL:** Graphic tool to trend the raw or the output voltage.
- 9 **PEAK TABLE:** edit a peak event table to change all possible parameters at specific time analysis can be started manually or by digitally and the detector will follow your specific configuration.
- 10 Maintenance menu: all tools to troubleshoot the detector is provided.

NEW ERA



OF LIGHT HYDROCARBON MEASUREMENT

Looking for a **SAFE, SENSITIVE, LOW OPERATION COST** and **MAINTENANCE FREE** system?

The patent pending **PlasmaDetek-E** is the solution



SAFE

No fuel (H_2) and no related safety accessories



SENSITIVE

< 1 ppb lowest detection possible



LOW OPERATING COST

Only N_2 carrier gas supply



MAINTENANCE FREE

No periodic detector cleaning

TYPICAL INSTALLATION FOR LIGHT HYDROCARBON MEASUREMENT

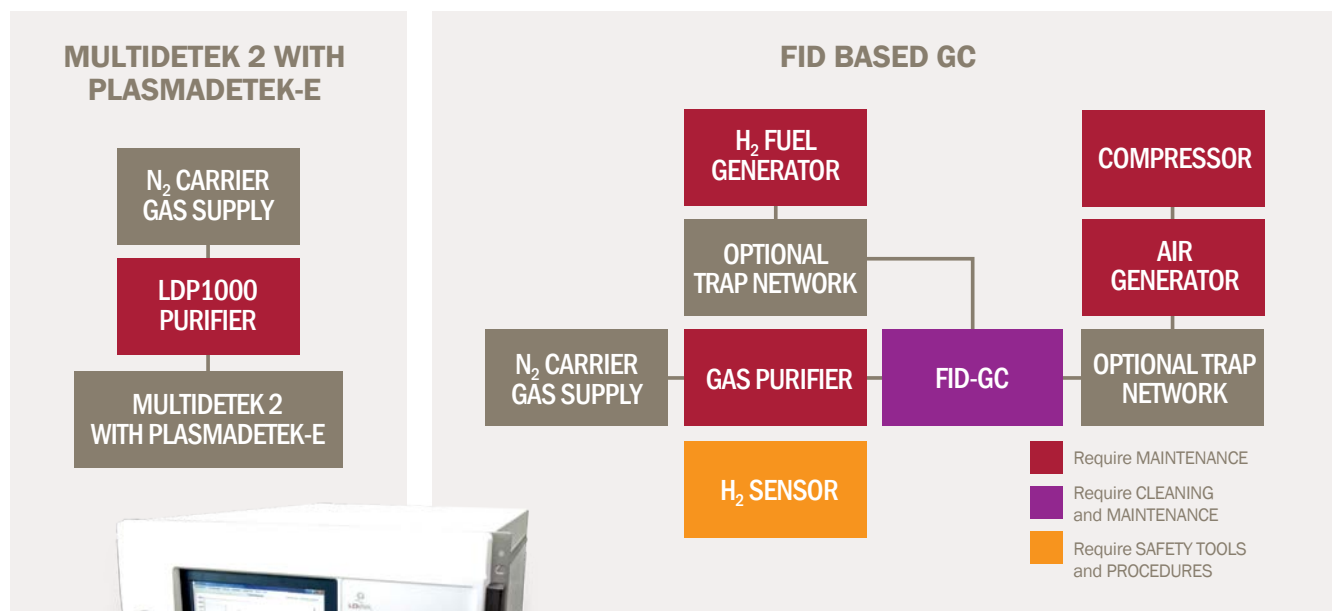

INSTALLATION COST* COMPARISON

Parts	MultiDetek 2 with PlasmaDetek-E	FID-GC
H ₂ generator	N/A	\$7200
Zero air generator	N/A	\$2125
Air compressor	N/A	\$1200
H ₂ safety accessories	N/A	\$1500
2 year maintenance cost	\$2000	\$5000
Total cost*	\$2000	\$17 025

* costs are approximate and may vary for each system

N/A: not applicable

Please consult Application Note LD14-01 on LDetek web site for more technical details.

MMD₃

MULTIDETEK3

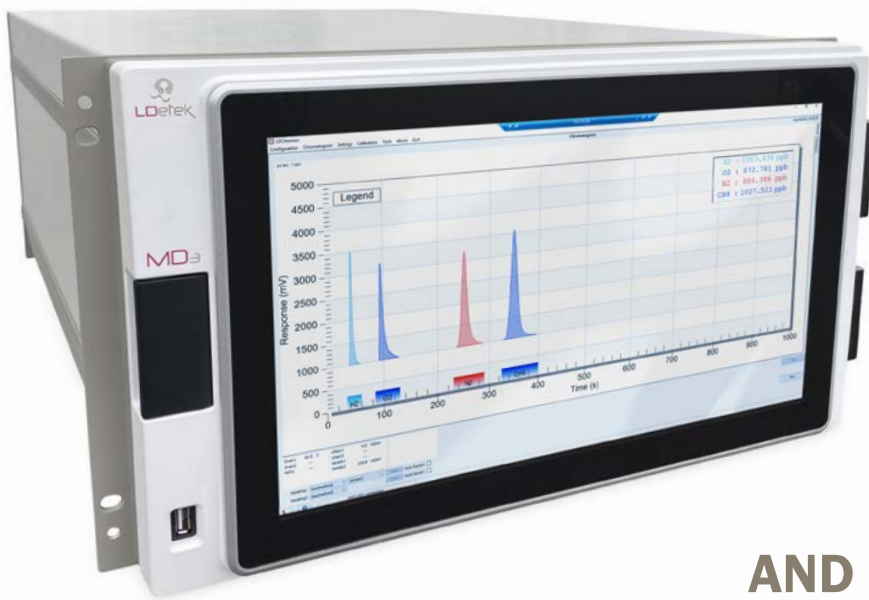

COMPACT GAS CHROMATOGRAPH FOR INDUSTRIAL AND LAB APPLICATIONS

The MultiDetek3 is the latest development of our popular range of compact industrial gas chromatographs. It is more than a simple gas chromatograph: it's a modular process GC instrument, that combines the functionality of two GCs in one with the ability to also monitor trace moisture and oxygen online. The instrument has been completely redesigned and features an extra-large 15.6" touch screen for easy visibility and operation. It has a dual sample inlet and online modules which allow simultaneous stream analysis of trace moisture and oxygen together with trace impurities. It is temperature controlled for improved stability and performance. The software interface is our latest LDChroma+, which offers more sophisticated data management and a planning platform.

FEATURES & DESIGN:

- One chassis configuration (6U Rackmount)
- Multiple GC analysis methods capacity
- GC can be configured with PED/TCD/FID detectors
- Up to 6 isothermal or 3 programmable oven combination
- Up to 5 high purity proportional diaphragm valves (carrier-sample)
- Easy maintenance with our modular design
- ppt, ppb, ppm and % gas analysis
- Built in PC with 15.6" with wide touchscreen
- Up to 10 high performance diaphragm valves
- Ethernet connectivity for remote control
- Serial/Profibus/Modbus communication protocols
- Fast parallel chromatography
- LDChroma+, LDCS, LDreport user friendly interfaces
- 2 GCs in one with 2 sample inlet ports & simultaneous analysis
- First GC having online sensors built in for trace moisture and oxygen analysis
- Temperature controlled process GC



TWO TRAINS DESIGN

2 sample inlets to analyse 2 streams independently in parallel. Replace 2 GCs per one MD3 unit for cost saving.



TEMPERATURE CONTROLLED GC

for the best stability and performances. Process GC design.

CHOICE OF ONLINE O2 SENSOR BUILT IN

- Electrochemical
- Zirconia



CHOICE OF ONLINE H2O SENSOR BUILT IN

- Quartz Crystal Microbalance
- Ceramic Metal-Oxide



LDCHROMA+

Gas Chromatography software interface



LDACS

planning and control system software



LDREPORT 2.0

software for data management and storage

SPECIFICATIONS

GAS CHROMATOGRAPHY DETECTORS	PED / TCD / FID
ONLINE DETECTORS	Quartz Crystal Microbalance / Ceramic Metal-Oxide / Electrochemical / Zirconia
STANDARD FEATURES	<ul style="list-style-type: none"> • Temperature controlled process GC • 15,6" wide touchscreen with 1366 x 768 HD resolution (IP65) • Windows 10 IoT • Ethernet ports available for remote control and Modbus • Self diagnostic system with maintenance planning • Isothermal and/or programmable ramping ovens • Electronic flow control regulators for carrier & sample gases • 4-20 mA isolated outputs • Alarm Historic • Digital system status output for remote monitoring (dry relay contact) • 2 alarms contact • High resolution Chromatogram output
OPTIONS	<ul style="list-style-type: none"> • Serial communication (RS232/485) / Profibus / Modbus / Ethernet • Compact purifier attached to the chassis for generating high purity carrier gas • Integrated stream selector system • Digital inputs for remote starting • Analog inputs for connecting external instruments • Remote control for stream selector (LDGSS) • Split/split less injector (can be heated) • Dual sample inlets with simultaneous analysis • Built in online sensor module for trace moisture: Quartz Crystal (ppb/ppm) or Ceramic (ppm) • Built in online sensor module for trace oxygen: Electrochemical (ppm) or Zirconia (ppm)
GAS CONNECTIONS	1/8" or 1/4" VCR or compression fittings
CARRIER PRESSURE REQUIREMENTS	100 PSIG (other carrier pressure available on request)
AMBIENT OPERATING TEMPERATURE RANGE	10 °C - 45 °C
AMBIENT TEMPERATURE CONTROL RANGE FEATURE	20 °C - 40 °C (out of this range, surrounding ambient temperature must be stabilized)
SUPPLY	115 VAC, 50 - 60 Hz or 220 VAC, 50 - 60 Hz
POWER CONSUMPTION	Maximum 500W
REPEATABILITY	Three times the percentage of deviation (3*CV %) of each component has to be smaller than 5% on ten consecutive cycles
LDL	3 times noise level
LOQ	3 times LDL value
LONG TERM STABILITY & DRIFT	Three times the percentage of deviation (3*CV %) of each component has to be smaller than 10% for 8 hours
LINEARITY	For 5 points within the measuring range, the linear curve must have its R2 at a value between 0.998 and 1.00

CERTIFICATION

CE & UKCA in compliance with EMC directive IEC 61000-6-2 : 2016 (immunity) & IEC 61000-6-4 : 2018 (emission) for equipment used in industrial environment

DIMENSIONS

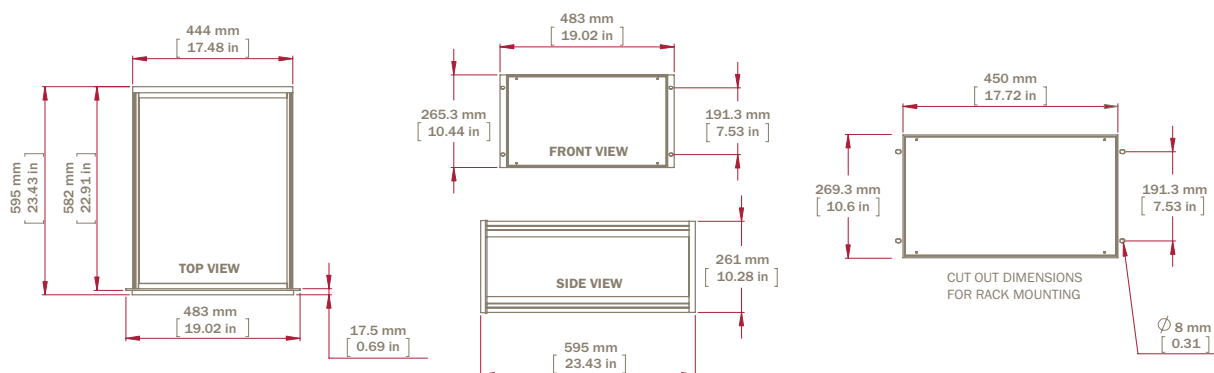

DETECTOR'S SPECIFICATIONS USED IN THE MULTIDETEK3

Detectors	PED	FID	TCD
CARRIER GAS	Argon/Helium/Nitrogen	Argon/Helium/Nitrogen/Hydrogen	Argon/Helium/Nitrogen/Hydrogen
LDL	100ppt (Helium carrier)	1ppb	1ppm
SELECTIVITY/ RESPONSE	Selective to photons generated by each impurity. Narrow bandpass filter optic circuit is used for each impurity. Background gas interference is blocked.	Selective to carbon by ions collection	Selective to thermal gas conductivity difference with carrier gas used
IP	Patent US9310308 Patent US20170254786	n/a	n/a
SAFETY ADVANTAGES	No fuel required	n/a	No fuel required
TECHNICAL ADVANTAGES	<ul style="list-style-type: none"> • Maintenance free (more than 10 years) • Sensitivity down to ppt • Selectivity for most of individual impurity • One gas source required only • Inert quartz detector 	n/a	n/a
IMPURITIES	Permanent & noble gases, sulfurs, ammonia, hydrocarbons, aldehydes, btex, alcohols...	Hydrocarbons, CO-CO2	Permanent & noble gases, sulfurs, ammonia, hydrocarbons, aldehydes, btex, alcohols...
APPLICATIONS	<ul style="list-style-type: none"> • Industrial gases • Energy • Semiconductor & Electronics • Food & Beverage • Environment • Laboratory 	<ul style="list-style-type: none"> • Industrial gases • Energy • Food & Beverage • Environment • Laboratory 	<ul style="list-style-type: none"> • Industrial gases • Energy • Food & Beverage • Environment • Laboratory



LDchroma+ gas chromatography software for process/lab analyses

LDchroma+ software is used to control the internal components of the MultiDetek3 gas chromatograph and make the bridge with the surrounding industrial environment and the rest of the world offering a full remote control of your instrument.

What it controls internally?

- ▶ Temperatures, flows, valves, detectors, A/D inputs, A/D outputs, streams selection, calibration, alarms

What kind of intelligence it offers?

- ▶ Maintenance interval/cost and lifetime of components
- ▶ A choice across a multiple peak detection algorithms is automatically selected
- ▶ Secure, administrator-controlled user access and permissions to ensure data integrity
- ▶ Simplified run creation, including sequence, methods and reports

How it communicates with the external world?

LDchroma+ can talk with automated systems using Modbus, Profibus or Profinet (other protocols available on request) depending on the requirements. It is generally used to send/receive any type of commands and results with the plant.



For the remote control of the LDchroma+ software, the Ethernet connection also allows the use of any type of remote control software compatible with Windows. It becomes easy to operate your gas analyser at distance and also select your desired method/stream and even calibrate it.



LDreport 2.0 for data management

LDreport 2.0 can perform many different types of report format. You can customize the analysis certificate as you desire. LDreport 2.0 can save in multiple format as pdf, excel and html. You can also print it on your local printer or any printer connected on the network. Adding company logo and other custom information can be put on the report template as well.

LDreport 2.0 is also used as database where you have access to all chromatograms and results from your instrument. It is very useful to compare results, trends, chromatograms by selecting any period range. LDreport 2.0 is well designed to simplified backup, searching, and trending of chromatography data.



LDACS Control System

Planning and management software tool offering the possibility to manage and plan actions from a complete LDetek turnkey system. Including calibration routine, dilution, stream sequence, test sequence, collection of data from a third party analyser, carrier consumption & pressure monitoring and many more all built up and running in one platform. *For listing one example, what's better than having your instrument running a linearity check by itself and giving you the final results.*

HOW OUR SOLUTION MAKES YOUR LIFE EASIER



ROBUSTNESS & MODULARITY

Nothing better than showing our own gas chromatograph to demonstrate a symbol of robust and modular design offering all the gas analysis possibilities inside one compact instrument. Your application has changed, and your instrument must be re-configured? No problem! Our modularity design makes it easy to readapt the instrument to your actual need. Design by experts, for leaders.

REMOTE ACCESS

Remote connection through network allows our experts to access your instruments for quick support. Our platform infrastructure allows to access the internal database of the instrument to know all the historic events. Years of information, access in a second.

WORLDWIDE HIGH SKILL TECHNICAL RESSOURCES

Wherever you are located, we have high skill experts ready to help you. Our training program within our organization makes our technical resources always up to date and ready.

WARRANTY & TRADE IN PROGRAMS

Extended warranty programs are there to make your life easier. Our high value design product gives you a residual value at its end of life to trade with our latest technology available. Let us work for you!

HOW WE MEASURE CONFIDENCE



By having the demonstration of our ability to build robust solutions based on highly skilled involved employees and high quality criteria company philosophy. This is represented by long durability of our instruments being more than 11 years. At the end of this cycle, our company engagement is proud to open discussions to offer the residual value of your highly valuable analytical instrument in exchange for our latest technology device suitable for your application.

ASK US FOR OUR SERVICE
AND WARRANTY PROGRAMS AVAILABLE



Apply your residual value
with our trade-in program
with latest technology

FULL WARRANTY 18 MONTHS

EXTENDED WARRANTY PROGRAM UP TO 10 YEARS

MAINTENANCE PROGRAM EVERY 3-5 YEARS



MultiDetek₃EX



EXPLOSION PROOF GC SOLUTION DESIGNED FOR HAZARDOUS AREAS



▲ MultiDetek3



▶ MultiDetek3 EX

An innovative design based on simplicity. The standard industrial compact GC model MultiDetek3 is now integrated inside a Stainless Steel certified (ATEX-IECEX) purged enclosure to be used in Zone 1 and Zone 2 hazardous areas. This “EX” series allows to keep the proven robust industrial platform features of the MultiDetek3 with its LDChroma software interface. It also allows to mount more than one GC or other instruments/accessories in the same MultiDetek3 EX purged enclosure. On top of that, using the standard rackmount platform of the MultiDetek3 mounted on a slide out system makes it easy to swap units inside the enclosure for maintenance or application upgrade. A multi streams/GCs and methods all in one system approaches was the objective with the launch of the MultiDetek3 EX series.

FEATURES

- Explosion proof for use in zone 1 and zone 2
- Capable to integrate multiple instruments and sampling system all in one unit
- Designed to mount up to 2 standard units' model MultiDetek3
- Easy to swap and access units inside the enclosure with its slide out design
- Triclops X purge controller is capable to feed up to 3 enclosures in cascade or parallel for more possibilities.
- Stainless Steel cabinet with secured doors (IP66)
- Wall mount or floor mount available
- Front industrial panel PC
- LAN remote control for GC and stream selector
- LDChroma industrial GC interface with LDReport database software
- Industrial communication protocols (Modbus-Profibus from Ethernet/RS232/RS485)
- Up to 10 analog outputs 4-20mA
- Up to 6 isothermal ovens to fit capillary, micropacked or packed columns with an easy access to replace columns.
- Up to 10 diaphragm/rotary valves to build multiple methods for multiple streams
- Can combine up to 3 detectors in one GC (PED, TCD, FID, Quartz crystal for H₂O, electrochemical sensor or third party sensor)
- Electronic pressure and flow controllers
- Corrosion resistant material available (option)
- Analysis in ppb/ppm/%
- One status alarm contact and two levels alarm contacts are available
- A non-purged version is also available for use in safe zones

INDUSTRIES/APPLICATIONS

- Hydrogen Production
- Hy/CO Plants
- Hydrocarbons Processing
- Petrochemicals (measurement of CO-CO₂)
- Chemical Plants
- Natural Gas/LNG Processing
- Electronic Gases
- Air Separation Units (ASU)
- Refineries (analysis of CO in propylene and ethylene)
- Synthesis Gas (measurement of H₂)
- Other related industries



DESIGN

Area for mounting accessories as extra sensors and/or gas purifier (LDP1000) or others.

Front Panel PC with 8.4" LCD.

MultiDetek3 slide out design for easy access (enough space available for a second slide out for another MultiDetek3).

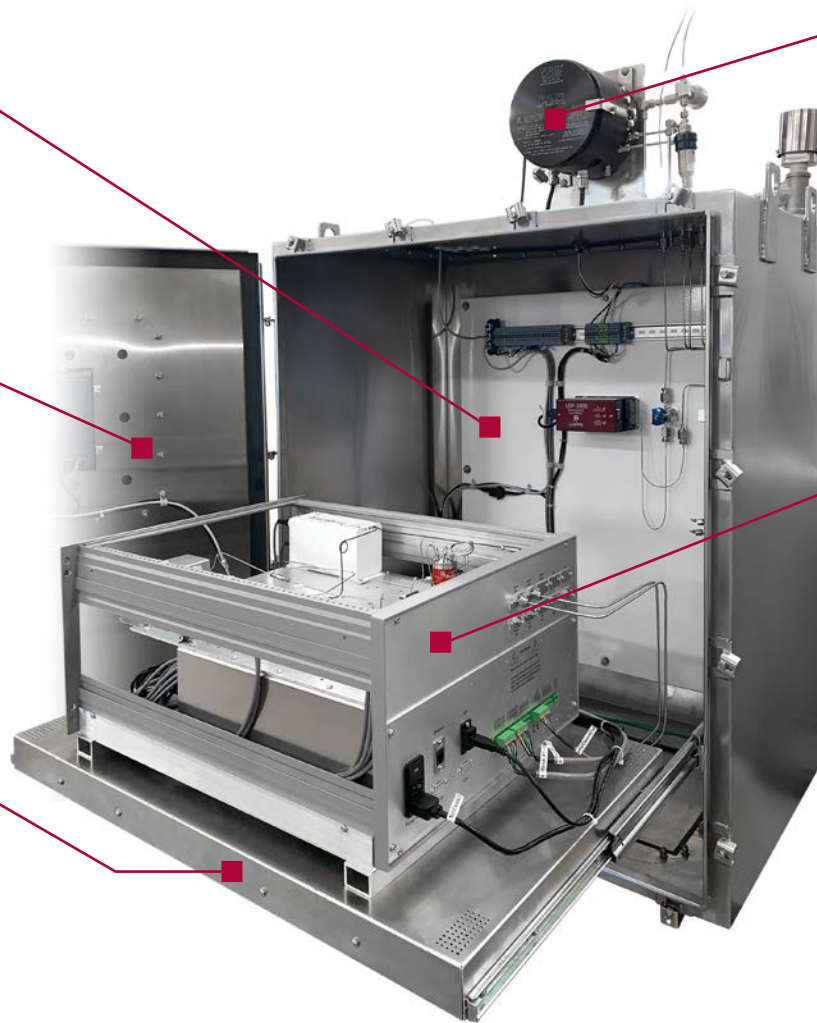

Tryclops-X purge system proved according to EN 60079 (The same device can feed up to 3 different EX cabinets).

MultiDetek3 GC instrument having capacity to mount multiple ovens(6x)/ detectors(3x)/ valves(10x)/ electronic flow controllers(5x) for analysis of multiple streams with multiple methods built in.

An ultra high purity 4 channels stream selector can be integrated in the GC.

DIMENSIONS

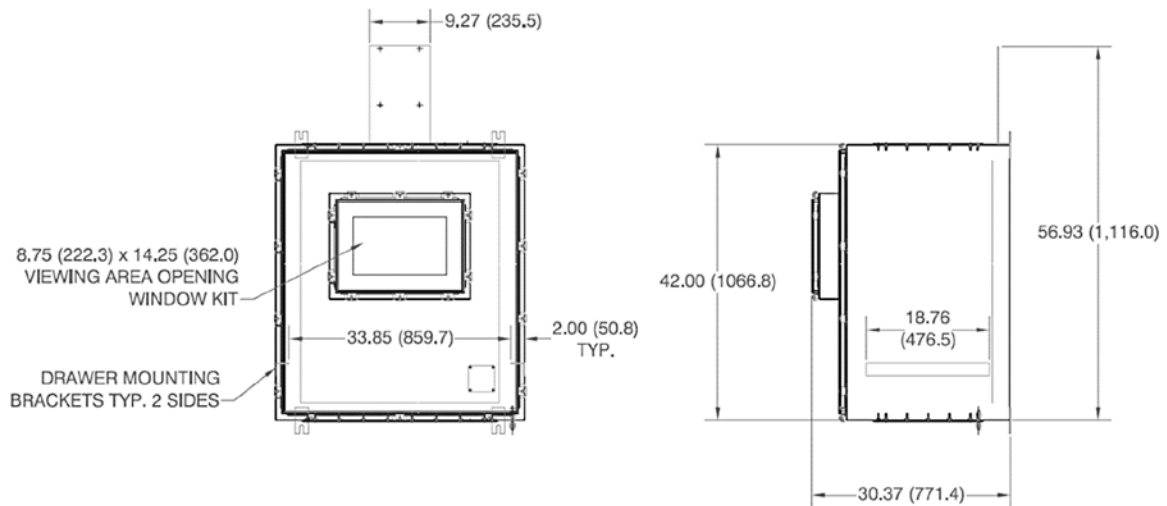

SPECIFICATIONS

GENERAL DIMENSIONS	38" W (965mm) X 30.37"D (771mm) X 56.93" H (1116mm) (other sizes available on request)
MATERIAL	Stainless Steel
DOOR CLEARANCE	37" (932 mm)
WEIGHT	227 kg
STANDARD FEATURES	<ul style="list-style-type: none"> • 1 Tryclops X-Purge controller, XP version certified for Zone 1 and Zone 2 hazardous areas • 1 air Exhaust • 1 air purge gas inlet kit • 1 8.4" panel PC per MultiDetek3 GC • 1 Adjustable check valve on sample gas • 1 Flashback arrestor on sample gas • 1 pneumatic shut off valve on sample gas
OPTIONS	<ul style="list-style-type: none"> • 1 Vortex cabinet cooler with AC muffler • Additional instruments can be added • Up to three purged enclosures can be mounted in cascade using the same Tryclops • Floor mount rack
OPERATING ENVIRONMENT	Indoor and outdoor
CARRIER GAS PRESSURE	100 PSI (6.9 bar)
SAMPLE GAS PRESSURE	5-30 PSI (0.35-2 bar)
GAS CONNECTIONS	1/8" or 1/4" VCR or Compression type (Swagelok)
PURGE PROTECTIVE GAS SUPPLY QUALITY	Dry air grade : Water and oil-free, - 40° F (- 40° C) dew point, particles 5µ, ISA grade hydrocarbon-free
SUPPLY	115 VAC, 50 – 60 Hz or 220 VAC, 50 – 60 Hz
POWER CONSUMPTION	Maximum 660 watts
APPLIED STANDARDS	<ul style="list-style-type: none"> • EN60079-0 • EN60079-2 • EN60079-7 • EN60079-11 • EN60079-15 • EN60079-18
CERTIFICATIONS	IECEX : Ex pxb IIB+H2 T4 Gb ATEX : II 2 G Ex pxb IIB+H2 T4 Gb CE (MultiDetek3)
OPERATING TEMPERATURE	-20 °C to 47 °C
T CLASSIFICATION	T4
IP	66
ENCLOSURE VOLUME	727.8 liters
MINIMUM PURGE FLOW	120 L/min
MINIMUM PURGE TIME ON START-UP	78 minutes
MAXIMUM OVERPRESSURE	0.1 PSI (6.7 mBar)
MINIMUM OVERPRESSURE	0.02 PSI (1.24 mBar)
MAXIMUM SUPPLY AIR PRESSURE	100 PSI (6.9 bar)
MINIMUM SUPPLY AIR PRESSURE	15 PSI (1.4 bar)

LD8000



TRACE NITROGEN IN ARGON, HELIUM AND CRUDE ARGON ANALYZER



The LD8000 is an online analyzer to monitor trace N₂ in Ar/He/Crude Argon. Plasma emission detector is used to selectively measure trace N₂ in Argon or/and Helium bulk gases. The analysis of trace N₂ in Neon, Xenon and Krypton can also be realized.

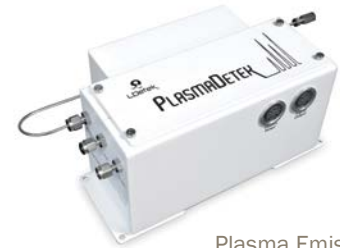

Plasma Emission
Detector for N₂

FEATURES:

- Trace Nitrogen in Argon/Helium/Crude Argon
- Compact 3U rackmount enclosure
- Large scale measurement
- 4-20 mA outputs as standard
- LAN/Web control
- Range Identification Relay
- Micro-valve for very low dead volume and fast purging time
- Low sample consumption
- Optional zero gas calibration free system

APPLICATIONS:

- Air separation unit
- Helium cryogenic installation
- Cryogenic truck loading station
- Speciality gas laboratories
- Process control
- Argon purification plant
- Steel Industries
- Chemical plants
- Welding gas control
- Helium liquification plants
- Gas management system
- Semiconductor manufacturing
- Quality control for truck fills and gas cylinders
- Inert glove box systems
- Universities and laboratories

SPECIFICATIONS:

DETECTOR TYPES	Plasma Emission Detector for N ₂	
RANGE FOR N₂	0 – 1 ppm, resolution to 10 ppb 0 – 10 ppm, resolution to .1 ppm	0 – 100 ppm, resolution to 1 ppm other range possible up to 5000 ppm configurable
STANDARD FEATURES	<ul style="list-style-type: none"> Manual or autoranging (user selectable) Microprocessor controlled 5.6" TFT intelligent LCD module with Touch Screen Self diagnosis system with auto-resolve alarm 4-20 mA isolated outputs 	<ul style="list-style-type: none"> Alarm Historic Safe calibration procedure to avoid any bad calibration Digital outputs for remote monitoring: (all dry relay contacts) <ul style="list-style-type: none"> - System status (1 output) - Range in use (3 outputs per impurity) - Calibration in use (1 output)
OPTIONS	<ul style="list-style-type: none"> Internal sampling system for zero, span and sample 	<ul style="list-style-type: none"> Serial port: RS-232 / 422 / 485 / Profibus 2 alarm outputs (user programmable set point) Zero calibration gas free system
GAS CONNECTIONS	Sample: 1/8" compression fittings	Vent: 1/8" compression fitting
CALIBRATION GAS	Zero: LDP1000 purified gas (Getter)	Span: 8.0 to 9.5 ppm N ₂ (application dependant)
SAMPLE FLOW REQUIREMENTS	75 to 200 sccm	
OPERATING TEMPERATURE	10 °C to 45 °C	
SUPPLY	115 VAC, 50 – 60 Hz or 220 VAC, 50 – 60 Hz	
ACCURACY	Better than ± 1% full scale	
DRIFT	< ± 1%	
RESPONSE TIME	T90 < 10 seconds	
OPERATING SAMPLE PRESSURE RANGE	3-30psig (for lower sample pressure requirement, an additional high purity pump is used)	
OUTLET PRESSURE	Atmospheric	
ENCLOSURE TYPE	3U rackmount type	
INGRESS PROTECTION	IP20 in accordance with IEC 60529	
ENCLOSURE FINISH	RAL7030 powder coat	
CERTIFICATION	In compliance with EMC directive 2004/108/EC, EN 61000-6-2:2005 for immunity & EN 61000-6-4:2007 for emissions	
WEIGHT	29 lbs (13 kg)	

ORDERING INFORMATION:

LD8000	-X	-X	-XXX	-X	-XX	-X	-XXX	-X
	N2: Nitrogen	A: Argon H: Helium C: Crude Argon D: Dual (Argon + Helium)	Operating Voltage: 120: 120 volts 220: 220 volts	A: Alarm option	Integrated sampling system S1: 1 sample + zero + span S2: 2 samples + zero + span	C: Zero gas free system	Serial communication: RS2: RS-232 RS4: RS-485 PFB: Profibus	P: Purge valve and flowmeter

DIMENSIONS:

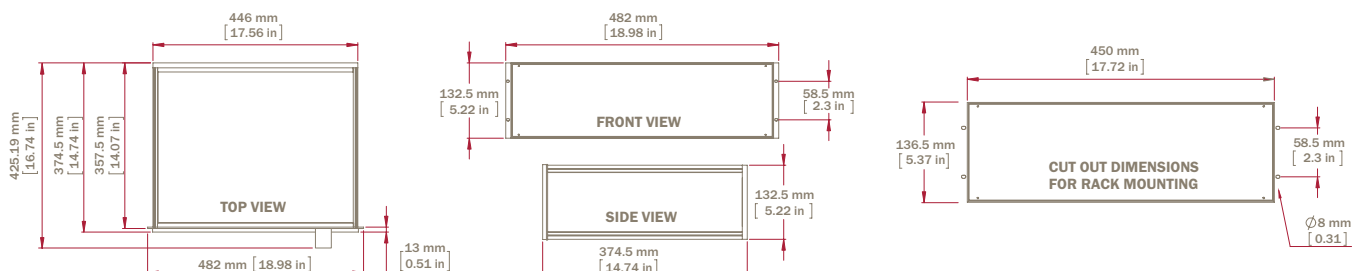

Where innovation leads to success

www.ldetek.com

LD8000 PLUS



ONLINE PPB TRACE NITROGEN IN ARGON/HELIUM ANALYZER



The LD8000-Plus is designed for ultra-pure Argon or Helium gas analysis. With its integrated ppb sub-system, unique performance can be achieved. Low ppb trace nitrogen online is now possible without the need of a gas chromatograph. This compact design makes it very attractive for any industrial or laboratory installation.

FEATURES:

- Unique Plasma Emission Detector design based on a Duty Cycle Controlled System.
- PPB sub-system integrated
- Bootloader integrated for software update via Ethernet
- Large scale measurement
- 4-20 mA output as standard
- Range Identification Relay
- Maintenance free
- Bypass sample flow control to insure high purity
- Low sample consumption
- 3U cabinet

APPLICATIONS:

- Air separation unit
- Speciality gas laboratories
- Process control
- Argon purification plant
- Chemical plants
- Helium liquification plants
- Gas management system
- Semiconductor manufacturing

SPECIFICATIONS:

DETECTOR TYPE	Plasma Emission Detector design based on a Duty Cycle Controlled System. Sub ppb system integrated.	
RANGE	0 - 50ppb : resolution 0.1ppb 0 - 500ppb : resolution 1ppb	0 - 1000ppb : resolution 1ppb
REPEATABILITY & ACCURACY	Greater of <+/- 1% of the reading or the ldl	
STANDARD FEATURES	<ul style="list-style-type: none"> Manual or autoranging (user selectable) Microprocessor controlled 5.6" TFT intelligent LCD module with Touch Screen Self diagnosis system with auto-resolve alarm Integrated heated gas purifier for zero gas reference 	<ul style="list-style-type: none"> 4-20 mA isolated output Alarm Historic Digital outputs for remote monitoring: (all dry relay contacts) <ul style="list-style-type: none"> - System status (1 output) - Range in use (3 output) - Calibration in use (1 output)
OPTIONS	<ul style="list-style-type: none"> Serial port: RS-232 / 422 / 485 / Profibus 2 alarm outputs (user programmable set point) 	
GAS CONNECTIONS	Sample: 1/8" face seal fittings	Vent: 1/8" compression fitting
CALIBRATION GAS	Zero: with integrated heated gas purifier connected on sample gas line	Span: 100-500ppb N2 in balance Argon or Helium (LDGD5A accessory required)
SAMPLE GAS	Argon or Helium	
SAMPLE GAS REQUIREMENTS	150sccm at 15 psig to 500sccm at 30psig	
SAMPLE OPERATING PRESSURE	15-30psig (103-206 kpag)	
ACTUATION GAS REQUIREMENTS	Air at pressure 70-100psig (483-689 kpag)	
SAMPLE FLOW REQUIREMENTS	15 to 200 sccm	
OPERATING TEMPERATURE	10°C to 45°C (must be stable)	
SUPPLY	115 VAC, 50 - 60 Hz or 220 VAC, 50 - 60 Hz	
POWER CONSUMPTION	Maximum 150 watts	
STABILITY & DRIFT	<+/- 0.01% of the measuring scale	
LIMIT OF DETECTION (LDL)	0.1ppb Nitrogen	
RESPONSE TIME T90	1 minute	
WEIGHT	37 lbs (17 kg)	

ORDERING INFORMATION:

LD8000-Plus	-XXX	-X	-XXX
	Operating Voltage: 120: 120 volts 220: 220 volts	A: Alarm option	Serial communication: RS2: RS-232 RS4: RS-485 PFB: Profibus

DIMENSIONS:

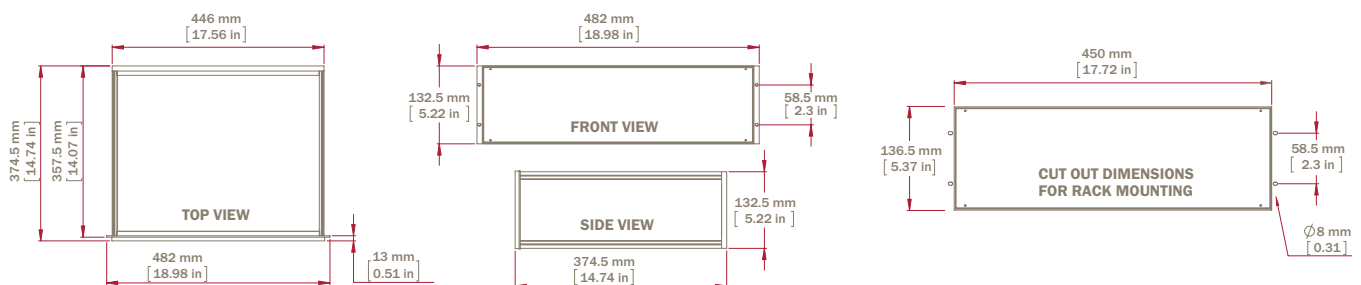

LD8000 MULTIGAS



TRACE NITROGEN, OXYGEN, MOISTURE, HYDROCARBONS ALL IN ONE UNIT



The LD8000MG is an online gas analyzer that can combine multiple sensors and technologies all in one unit to allow multiple impurities detection within a wide range of analysis.



▲ PlasmaDetek2



▲ SenzTx



▲ Easidew



▲ QMA

The unit is a rackmount 3U or 4U enclosure. The configuration depends on the sensors and options selected. Multiple configurations are available through a module platform philosophy.

FEATURES:

- Compact rackmount enclosure (3U or 4U) to cover up to four measurements (N₂, O₂, H₂O, CnHm)
- Bootloader integrated for software update via Ethernet
- Ultra high purity electronic flow controllers for sample flow control
- Large measurement scale
- Touchscreen 5.6" LCD
- 4-20 mA outputs
- Range Identification & alarm status & calibration contacts
- Alarm historic
- LAN/Web control
- Low sample consumption

APPLICATIONS:

- Industrial gas applications
- Inert and bulk gases
- Air separation unit
- Helium cryogenic installation
- Cryogenic truck loading station
- Process control
- Helium liquification plants
- Steel industry
- Chemical plants
- Gas generation
- Additive manufacturing
- Glove box purge and leak detection
- Research centers and laboratories

PROVEN SENSORS TECHNOLOGIES

PLASMADETEK (for more technical information, refer to our Design Report on LD8000 MultiGas series)

The measurement of the trace impurities N₂-O₂-H₂O-CnHm in a helium or argon matrix can be carried out with a PED type detector (PlasmaDetek2) US patent 9,310,308 B2 integrated into an instrument of the LD8000-Multigas type. This technology is based on cold microplasma excited at high voltage / frequency in a helium atmosphere and allowing the selective measurement of each component at a precise optical wavelength. The optical circuit is composed of photodiodes and interference filters combined with an amplification system for converting the measured photons into voltage. All signal processing is then redirected to a microcontroller.

Compared to previous art, the LD8000MG with PED sensor offers an interference free measurement. By the combination of selective bandpass optical filter with a nitrogen doping system and a network of adsorbents & permeation devices, each impurity is accurately measured without being affected by other impurities presence in the sample gas.

Several variants and options on this device are possible depending on the needs of the customer.

Low maintenance and cost of ownership

Using a non depleting PED sensor, the unit can be used for long term operation (over 10 years) without having to change it. This is also due to the network of protection adsorbent and the detector shut off system during upset conditions. The traps used in the unit are also protected by an isolation valve shut off in case of upset conditions. This is to ensure the durability of the traps and detectors inside the unit. All these factors combined together make our solution robust and minimize the maintenance on the unit.

Fast response time

The unit design allows to keep a minimal sample flow consumption and ensure a quick response time (T₉₀ at 10sec)by the use of 1/16"OD coated stainless steel lines. The flow controllers are mounted in bypass mode to minimize the gas volume and dead legs upfront of the PEDs.

SENZTX

With a choice of either zirconia or electrochemical sensor technology the SenzTx offers reliability, accuracy and flexibility. Both technologies have a broad measurement capability allowing the user to measure from selected ranges from 1ppm to 96% oxygen.

Zirconia sensor

The Ntron zirconia oxygen sensor is a nondepleting zirconia solid electrolyte sensor. A small capillary on the sensor controls the diffusion of oxygen into the sensor. When heated to over 400°C oxygen is electronically reduced causing current flow through the zirconia electrolyte. Zirconiumoxide allows the movement of oxygen ions through the substrate from a high to a low concentration. The measurement of oxygen is determined by the current flowing through the electrodes. The zirconia sensor has an unlimited shelf life without the loss of calibration and has an expected life in excess of 5 years. The zirconia sensor is not position sensitive and has low cross sensitivity to other gases and does not dry out.

Low maintenance and cost of ownership

Due to the highly stable nature of the sensor, a calibration interval of once per year is required, allowing for significant cost savings. The construction of our zirconia oxygen sensor means that only 100 mL/min of sample gas is required, providing application flexibility and further potential cost savings.

Fast response time

Zirconia oxygen sensors respond very quickly to oxygen concentrations in both directions with a T₉₀ of less than 10 seconds within a set range.

Electrochemical sensor

The key elements of the electrochemical sensors are a membrane, cathode, anode, electrolyte and measurement circuit. The sensing membrane (covering the cathode) is made of PTFE and is mounted over a metal perforated electrode. The space between the membrane and the electrode is filled either with an aqueous alkaline or an acid electrolyte. In normal operation, all portions of the anode and cathode are immersed in the electrolyte. As oxygen diffuses through the membrane into the electrolyte it causes a reaction between the cathode and anode generating an EMF. This current is proportional to the amount of oxygen present in the sample gas. In the absence of oxygen there is no output from the electrochemical sensor, meaning only one calibration is required.

EASIDEW

The Easidew transmitter has a wide measurement range from -110 to +20°Cdp (-166 to +68°Fdp) and one stocked product can be used across all class 1 to class 6 industrial dryer applications. The Easidew family of industrial transmitters incorporates the latest Michell advanced ceramic technology providing stable, reliable and repeatable moisture measurements for all dew point applications.

Ease of Installation

Flexible product design ensures the unit can be quickly and economically installed. • Mini DIN 43650 form C or M12 5 pin electrical connectors • 5/8" UNF, 3/4" UNF, G1/2" BSP process connections • 316 stainless steel transmitter sample blocks.

Measurement Performance

The transmitter uses Michell's market leading ceramic measurement technology coupled with the latest generation, sophisticated microcontroller electronics to provide accurate and stable measurement across the transmitter's product life.

QMA (for more technical information, refer to our Design Report for trace moisture analysis integrated inside the MultiDetek2 GC)

The Advanced Quartz Crystal Microbalance sensor from Michell Instruments is now integrated inside the LD8000MG to provide reliable, fast and accurate measurement of trace moisture content in a variety of applications where keeping moisture to a minimum is of critical importance. The analyzer provides consistently accurate measurements of trace moisture. This consistency is achieved using a self-calibration system, which adjusts the sensor with reference to an internal moisture generator.

Having such module inside the LD8000 multigas series allows to combine multiple impurities analysis with trace moisture inside the same instrument.

Quartz crystal microbalance sensor

A quartz crystal is sensitised with a thin film of hygroscopic material. Water molecules are adsorbed into the hygroscopic layer deposited on the surface. The change in mass modifies, in a very precise and repeatable manner, the oscillation frequency. The moisture concentration is measured as a change in the oscillation.

Quartz crystal sensor principle

The change in the oscillation is evaluated by switching the gas inside the sensor and by measuring the response delta. For sampling response, the sensor is balanced between a dry gas source and the sample source. The difference is then calculated. The same principle is applied for the span gas calibration. However, this time the comparison is between a dry gas and a source of wet gas. A cycling time of 30 seconds on each gas is used to compare the response delta.

Quartz crystal module principle

The dry gas comes from a reference gas source. The sensor is supplied by a known Helium or Argon or Nitrogen grade 5.0 carrier source going through a heated gas purifier model LDP1000 series. This combination generates a gas purity of 8N. By using this technique, the dry gas source contains less than 10ppb H₂O what is ideal as zero gas reference.

The wet gas comes from a certified water filled permeation tube heated at a controlled temperature of 45 Celsius. It generates a stable amount of moisture used for span calibration. The moisture generator is made of coated stainless steel to reduce the surface absorption of water molecules and then keep the moisture rate very stable and accurate. The flow inside the module is controlled and maintained by a network of calibrated orifices. All flow passageways upfront the sensor are less than 0.030"ID, all coated with an inert coating to accelerate the response/purge time and improve the performances of the system.

SPECIFICATIONS:

SENSOR MODEL	PLASMADETEK	PLASMADETEK	PLASMADETEK	PLASMADETEK	SENZTX	SENZTX	EASIDEW	QMA
MEASUREMENT TECHNOLOGY	PED	PED	PED	PED	Zirconia (ZR)	Electrochemical (EC)	Ceramic sensor	Quartz crystal
SENSOR MANUFACTURER	LDetek	LDetek	LDetek	LDetek	NTRON	NTRON	Michell Instruments	Michell Instruments
IMPURITY DETECTED	N2	O2	H2O	CnHm	O2	O2	H2O	H2O
SAMPLE GAS	Ar-He	Ar-He	Ar-He	Ar-He	multiple gases	multiple gases	multiple gases	multiple gases
RANGES* (DEFAULT)	0-1ppm (resolution 10ppb)	0-3ppm (resolution 10ppb)	0-3ppm (resolution 10ppb)	0-3ppm (resolution 10ppb)	0-10ppm (resolution 0.5ppm)	0-10ppm (resolution 0.1ppm)	0-10ppm (resolution 0.5ppm)	0-10ppm (resolution 100ppb)
	0-10ppm (resolution 100ppb)	0-30ppm (resolution 100ppb)	0-30ppm (resolution 100ppb)	0-30ppm (resolution 100ppb)	0-100ppm (resolution 1ppm)	0-100ppm (resolution 1ppm)	0-100ppm (resolution 1ppm)	0-100ppm (resolution 1ppm)
	0-100ppm (resolution 1ppm)	0-50ppm (resolution 1ppm)	0-100ppm (resolution 1ppm)	up to 30ppm available	0-1000ppm (resolution 1ppm)	0-1000ppm (resolution 1ppm)	0-1000ppm (resolution 1ppm)	0-1000ppm (resolution 1ppm)
	up to 5000ppm available	up to 50ppm available	up to 100ppm available		up to 96% available	up to 25% available	up to 3000ppm available	up to 2000ppm available
LIMIT OF DETECTION (LDL)	10ppb	50ppb	50ppb	50ppb	0.5ppm	0.1ppm	0.5ppm	20ppb
ACCURACY	<+/- 1% of scale	<+/- 1% of scale	<+/- 1% of scale	<+/- 1% of scale	<+/- 1% of scale	<+/- 1% of scale	<+/- 1% of scale	<+/- 1% of scale
RESPONSE TIME (T90)	<10 sec	<10 sec	<10 sec	<10 sec	<10 sec	<10 sec	<5 min	<5 min
SENSOR LIFE EXPECTATION	10 years	10 years	10 years	10 years	3-5 years	1 year	3-5 years	3-5 years
OPERATING TEMPERATURE RANGE	5-45 Celsius							
SAMPLE GAS TEMPERATURE	0-100 Celsius							
SAMPLE FLOW REQUIREMENT	25-200ml /min	25-200ml /min	25-200ml /min	25-200ml /min	100-200ml /min	100-200ml /min	1-5 L /min	300-500ml /min
OPERATING SAMPLE PRESSURE RANGE	3-30psig (for lower sample pressure requirement, an additional high purity pump is used)							
OUTLET PRESSURE	Atmospheric							
INLET FITTINGS	1/8" or 1/4" Swagelok compression or VCR							
OUTLET FITTINGS	1/8" or 1/4" Swagelok compression or VCR							
DOPING GAS REQUIREMENT	N/A	Nitrogen grade 5.0**	Nitrogen grade 5.0**	Nitrogen grade 5.0**	N/A	N/A	N/A	Nitrogen grade 5.0***
STANDARD FEATURES	Manual or autoranging, MCU embedded system, touchscreen 5.6" LCD, 4-20mA outputs, alarm historic, digital outputs for status, 3 ranges, calibration in progress							
OPTIONS	Internal sampling system for zero/span/sample, serial communication RS232-RS485-Modbus-Profibus, 2 level alarms, zero gas free calibration system							
SUPPLY	110VAC 50-60Hz / 220VAC 50-60Hz							
POWER CONSUMPTION	100-250 watts depending of the combination of sensors and options mounted in the unit							
ENCLOSURE TYPE	3U or 4U rackmount type depending of the combination of sensors and options mounted in the unit							
INGRESS PROTECTION	IP20 in accordance with IEC 60529							
ENCLOSURE FINISH	RAL7030 powder coat							
WEIGHT	25-40 lbs (11-18kg) depending of the combination of sensors and options mounted in the unit							
CERTIFICATION	In compliance with EMC directive 2004/108/EC, EN 61000-6-2:2005 for immunity & EN 61000-6-4:2007 for emissions							

* Ranges can be factory set to other values. ** Refer to LD8000MG design report for more details *** Zero & Span gas dry gas source

Where innovation leads to success

www.ldetek.com

ORDERING INFORMATION:

LD8000MG	-X-X-X-X	-XXX	-X	-XXX	-X	-XXX
	PEDN2: N2 by PED PED02: O2 by PED PEDH20: H2O by PED PEDCnHm: HC's by PED EC02: O2 by Electrochemical ZR02: O2 by Zirconia DPH20: H2O by ceramic sensor QMAH20: H2O by quartz crystal	Operating Voltage: 120: 120 volts 220: 220 volts	A: Alarm option	Integrated sampling system S1: 1 sample + zero + span S2: 2 samples + zero + span	C: Zero gas free system	Serial communication RS2: RS-232 RS4: RS-485 PFB: Profibus

DIMENSIONS:

3U RACKMOUNT ENCLOSURE:

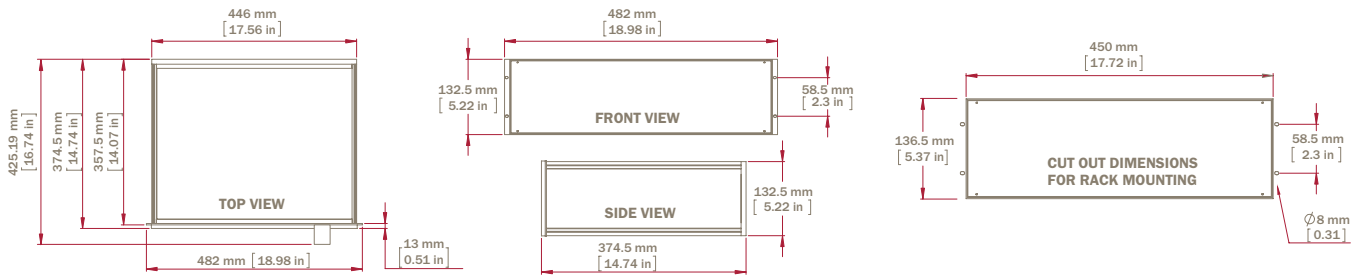

4U RACKMOUNT ENCLOSURE:

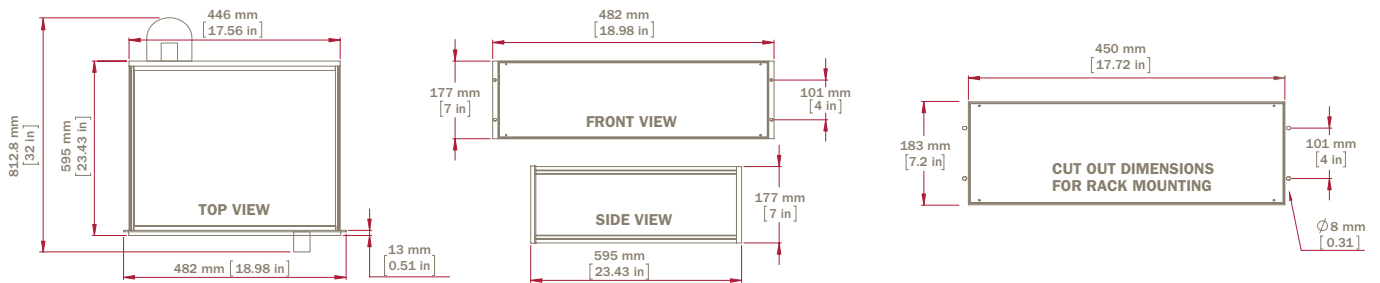

LD8000-TCD



BINARY GAS ANALYZER



The LD8000-TCD is a Thermal Conductivity-based Gas Analyzers used to measure and monitor binary gas streams. It can also monitor one component in a more complex gas mixture when the background gases have the same ratio to each other, or have similar thermal conductivity values.

FEATURES:

- Unique Thermal Conductivity Detector (TCD)
- Bootloader integrated for software update via Ethernet
- Large scale measurement
- 4-20 mA output as standard
- Range Identification Relay
- Maintenance free
- LAN/Web control
- Micro-valve for very low dead volume and fast purging time
- 3U cabinet

APPLICATIONS:

- Gas Manufacturing Facilities: monitoring Pressure Swing Adsorption (PSA) Systems
- Gas management system
- Gas Blending Equipment
- Air Liquification Plants: monitoring purity of Ar, O₂, H₂, N₂, He, CO₂, or Ne
- Welding gas control
- Steel Mills: CO₂ in off-gas from gas generators
- Petroleum Refineries: H₂ purity in C₁ - C₆ hydrocarbons
- Speciality gas laboratories
- Heat Treating: H₂ in N₂ and other annealing gases
- Process control
- Power Generation Plants: H₂ cooling gas in turbine generator housings; CO₂ in turbine generator housing; checking H₂ purity
- Ammonia Plants
- Chemical plants
- Refrigeration Facilities

Where **innovation** leads to **success**

www.ldetek.com

SPECIFICATIONS:

DETECTOR TYPE	Thermal Conductivity Detector (TCD)	
RANGE	Ppm to % (application dependant)	
ACCURACY	Better than $\pm 1\%$ full scale	
STANDARD FEATURES	<ul style="list-style-type: none"> Manual or autoranging (user selectable) Microprocessor controlled 5.6" TFT intelligent LCD module with Touch Screen Self diagnosis system with auto-resolve alarm LAN/Web control 	<ul style="list-style-type: none"> 4-20 mA isolated output Alarm Historic Digital outputs for remote monitoring: (all dry relay contacts) <ul style="list-style-type: none"> - System status (1 output) - Range in use (3 output) - Calibration in use (1 output)
OPTIONS	<ul style="list-style-type: none"> Internal sampling system for zero, span and sample 	<ul style="list-style-type: none"> Serial port: RS-232 / 422 / 485 / Modbus 2 alarm outputs (user programmable set point)
GAS CONNECTIONS	Sample: 1/8" compression fittings	Vent: 1/8" compression fitting
SAMPLE FLOW REQUIREMENTS	0 to 300 sccm	
OPERATING PRESSURE	3 to 30 PSIG	
OPERATING TEMPERATURE	10 °C to 45 °C	
SUPPLY	115 VAC, 50 – 60 Hz or 220 VAC, 50 – 60 Hz	
POWER CONSUMPTION	Maximum 40 watts	
DRIFT	Dependent of calibration	
WEIGHT	30 lbs (14 kg)	

ORDERING INFORMATION:

LD8000-TCD	-XXX	-X	-XX	-XXX
	Operating Voltage: 120: 120 volts 220: 220 volts	A: Alarm option	Integrated sampling system: S1: 1 Stream + zero + span S2: 2 Streams + zero + span	Serial communication: RS2: RS-232 RS4: RS-485 MOD: Modbus

Binary gases must be specified. Please contact factory.

DIMENSIONS:

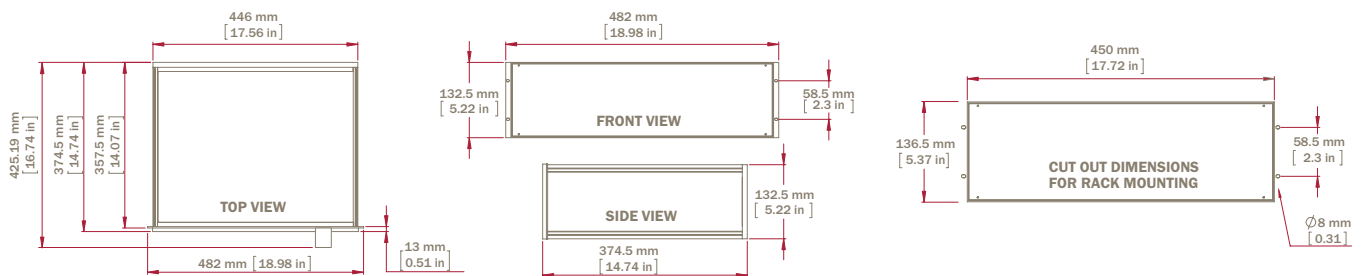

MOST COMPACT TRACE NITROGEN AND OXYGEN ANALYSER



LDSENZ ▲

The LDSENZ is our most compact nitrogen and/or oxygen analyser using our well proven plasma emission detector (PED) and the Senz-Tx (electrochemical/zirconia) series from NTRON. Combining both trace nitrogen and oxygen in the same instrument makes it compact and ideal for any of your applications.

APPLICATIONS

- Industrial/medical/laboratory
- Glovebox/Purged box/Additive manufacturing/Purification

CONFIGURATION

The module has its own integrated ultra high purity mini pressure regulator to reduce and maintain the inlet pressure of the sensors stable. A dedicated flow orifice is mounted before each sensor inlet to maintain a static flow based on the regulated pressure inlet. At the outlet of each detector, a flow sensor is mounted to measure the real flow going through each sensor. Continuous trace N₂ & O₂ analysis is performed in parallel. The Ethernet port gives an easy access to the interface. An optional 4-20mA output is available per sensor. Each of the analog output comes with a dry contact which can be used to trig some alarms.

SPECIFICATIONS

SENSOR MODEL	Senz-Tx	Senz-Tx	PED
MEASUREMENT TECHNOLOGY	Zirconia (ZR)	Electrochemical (EC)	Plasma emission detector
SENSOR MANUFACTURER	NTRON	NTRON	LDetek
IMPURITY DETECTED	O2	O2	N2
SAMPLE GAS	multiple gases	multiple gases	Argon/Helium
RANGES* (DEFAULT)	0-10ppm (resolution 0.5ppm) 0-100ppm (resolution 1ppm) 0-1000ppm (resolution 1ppm) up to 96% available	0-10ppm (resolution 0.1ppm) 0-100ppm (resolution 1ppm) 0-1000ppm (resolution 1ppm) up to 25% available	0-10ppm (resolution 100ppb) 0-100ppm (resolution 1ppm) 0-1000ppm (resolution 1ppm) up to 5000ppm available
LIMIT OF DETECTION (LDL)	1ppm	0.5ppm	10ppb
ACCURACY	<+/- 1% of scale	<+/- 1% of scale	<+/- 1% of scale
RESPONSE TIME (T90)	<10 sec	<10 sec	<10 sec
SENSOR LIFE EXPECTATION	3-5 years	1 year	>10 years
OPERATING TEMPERATURE RANGE	5-45 Celsius		
SAMPLE GAS TEMPERATURE	0-100 Celsius		
SAMPLE FLOW REQUIREMENT	100ml/min per sensor installed		
OPERATING SAMPLE PRESSURE RANGE	3-30psig (for lower sample pressure requirement, an additional high purity pump is used)		
OUTLET PRESSURE	Atmospheric		
INLET FITTINGS	1/8" or 1/4" Swagelok compression or VCR		
OUTLET FITTINGS	1/8" or 1/4" Swagelok compression or VCR		
STANDARD FEATURES	Modbus, Web interface(admin)		
OPTIONS	4-20mA outputs, Dry contact outputs		
SUPPLY	24VDC		

*One range available per sensor. Other ranges available on request.

TECHNOLOGY

PLASMA EMISSION DETECTOR

Plasma emission detector

It is used to trace nitrogen in Argon or Helium to offer fully stable/repeatable/linear and accurate response to nitrogen.

Plasma emission detector principle

The PED uses Helium or Argon as discharge gas in a sealed quartz chamber dedicated for measuring trace nitrogen at its specific wavelength. Nitrogen impurity is measured continuously through a quartz window that allows the light generated by the passage of nitrogen in the quartz chamber to be measured with its proper optical design.

Plasma emission module principle

The module is calibrated using a zero reference and a span reference. Generally, the zero comes from a grade 99.999% Argon or Helium that goes in our LDP1000 purifier series to generate grade 99.999999%. Going that way, it ensures the zero gas is well referenced to avoid negative reading. A second source of gas named span gas is used for the nitrogen span reference of the sensor. In this case, a certified gas containing about 10ppm N₂ in a balance Argon or Helium is then required. The module is then calibrated, accurate and linear within its operating range.

Fast response time

Plasma emission detector responds very quickly to nitrogen concentrations with a T₉₀ of less than 10 seconds within a set range.



SENZ-TX OXYGEN SENSOR

With a choice of either zirconia or electrochemical sensor technology the SenzTx offers reliability, accuracy, and flexibility. Both technologies have a broad measurement capability allowing the user to measure from selected ranges from 1ppm to 96% oxygen.

Zirconia sensor

The Ntron zirconia oxygen sensor is a nondepleting zirconia solid electrolyte sensor. A small capillary on the sensor controls the diffusion of oxygen into the sensor. When heated to over 400°C oxygen is electronically reduced causing current flow through the zirconia electrolyte. Zirconium oxide allows the movement of oxygen ions through the substrate from a high to a low concentration. The measurement of oxygen is determined by the current flowing through the electrodes. The zirconia sensor has an unlimited shelf life without the loss of calibration and has an expected life in excess of 5 years. The zirconia sensor is not position sensitive and has low cross sensitivity to other gases and does not dry out.

Low maintenance and cost of ownership

Due to the highly stable nature of the sensor, a calibration interval of once per year is required, allowing for significant cost savings. The construction of our zirconia oxygen sensor means that only 100 mL/min of sample gas is required, providing application flexibility and further potential cost savings.

Fast response time

Zirconia oxygen sensors respond very quickly to oxygen concentrations in both directions with a T₉₀ of less than 10 seconds within a set range.

Electrochemical sensor

The key elements of the electrochemical sensors are a membrane, cathode, anode, electrolyte and measurement circuit. The sensing membrane (covering the cathode) is made of PTFE and is mounted over a metal perforated electrode. The space between the membrane and the electrode is filled either with an aqueous alkaline or an acid electrolyte. In normal operation, all portions of the anode and cathode are immersed in the electrolyte. As oxygen diffuses through the membrane into the electrolyte it causes a reaction between the cathode and anode generating an EMF. This current is proportional to the amount of oxygen present in the sample gas. In the absence of oxygen there is no output from the electrochemical sensor, meaning only one calibration is required.



DIMENSIONS

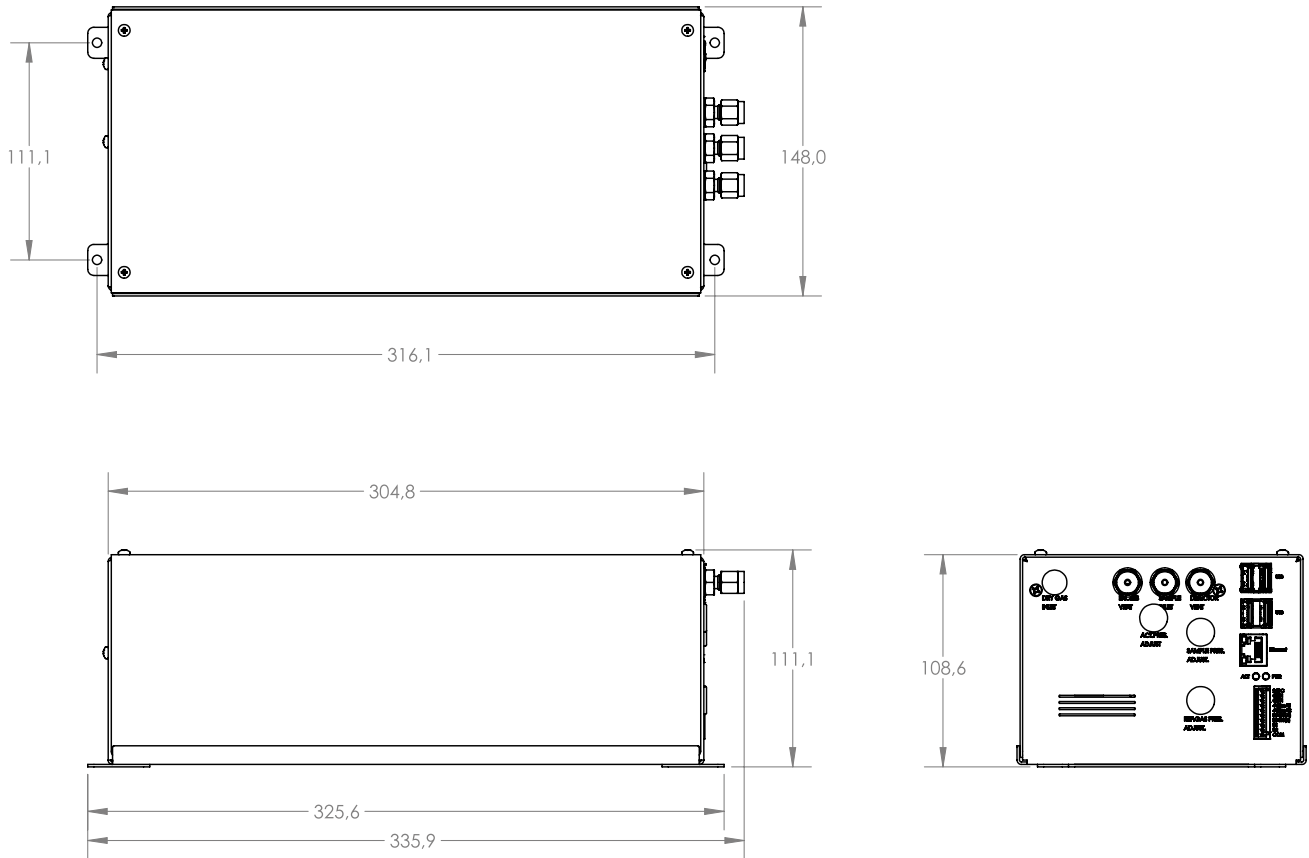

ORDERING INFORMATION

LDSENZ	-XXX	-XX	-XX	-XX
	PED : N2 plasma emission	EC : O2 electrochemical ZI : O2 zirconia	2S : 1/8" Compression 4S : 1/4" Compression 2FS : 1/8" face seal (VCR) 4FS : 1/4" face seal (VCR)	mA : 4-20mA

LDMOX



TRACE MOISTURE AND OXYGEN ANALYSER

The LDMOX is our most compact moisture and oxygen analyser using the well proven Quartz Crystal sensor from Michell Instruments and the Senz-Tx (electrochemical/zirconia) series from NTRON. Combining both trace oxygen and moisture in the same instrument makes it ideal for any of your applications.

APPLICATIONS

- Industrial
- Medical
- Laboratory

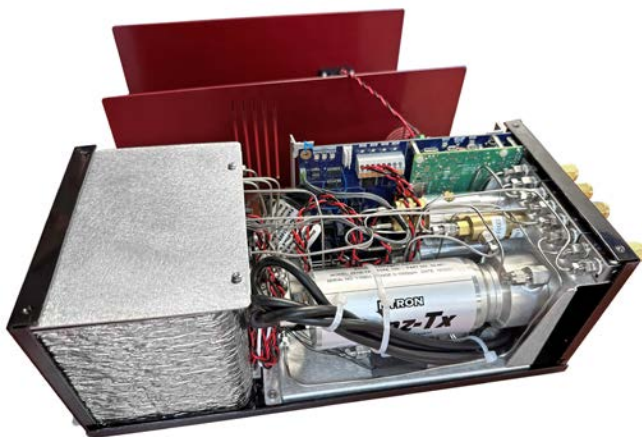
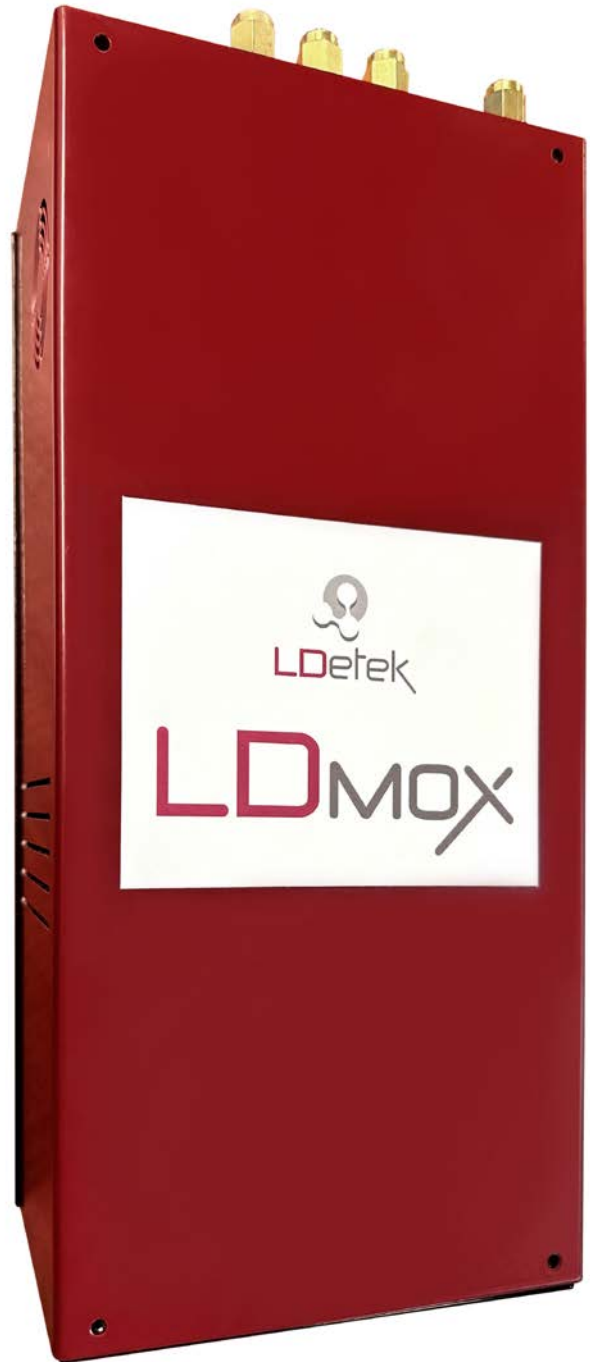

SPECIFICATIONS:

SENSOR MODEL	SENZ-TX	SENZ-TX	QMA
MEASUREMENT TECHNOLOGY	Zirconia (ZR)	Electrochemical (EC)	Quartz crystal
SENSOR MANUFACTURER	NTRON	NTRON	Michell Instruments
IMPURITY DETECTED	O2	O2	H2O
SAMPLE GAS	multiple gases	multiple gases	multiple gases
RANGES* (DEFAULT)	0-10ppm (resolution 0.5ppm)	0-10ppm (resolution 0.1ppm)	0-10ppm (resolution 100ppb)
	0-100ppm (resolution 1ppm)	0-100ppm (resolution 1ppm)	0-100ppm (resolution 1ppm)
	0-1000ppm (resolution 1ppm)	0-1000ppm (resolution 1ppm)	0-1000ppm (resolution 1ppm)
	up to 96% available	up to 25% available	up to 2000ppm available
LIMIT OF DETECTION (LDL)	1ppm	0.5ppm	20ppb
ACCURACY	<+/- 1% of scale	<+/- 1% of scale	<+/- 1% of scale
RESPONSE TIME (T90)	<10 sec	<10 sec	<5 min
SENSOR LIFE EXPECTATION	3-5 years	1 year	3-5 years
OPERATING TEMPERATURE RANGE	5-45 Celsius		
SAMPLE GAS TEMPERATURE	0-100 Celsius		
SAMPLE FLOW REQUIREMENT	100ml/min per sensor installed		
OPERATING SAMPLE PRESSURE RANGE	5-30psig (for lower sample pressure requirement, an additional high purity pump is used)		
OUTLET PRESSURE	Atmospheric		
INLET FITTINGS	1/8" or 1/4" Swagelok compression or VCR		
OUTLET FITTINGS	1/8" or 1/4" Swagelok compression or VCR		
STANDARD FEATURES	Modbus, Web interface(admin)		
OPTIONS	4-20mA outputs, Dry contact outputs		
SUPPLY	24VDC (Power supply included for 85VAC/240VAC)		
WEIGHT	10lbs (4.5Kg)		



Senz-TX oxygen sensor

With a choice of either zirconia or electrochemical sensor technology the SensTx offers reliability, accuracy and flexibility. Both technologies have a broad measurement capability allowing the user to measure from selected ranges from 1ppm to 96% oxygen.

Zirconia sensor

The Ntron zirconia oxygen sensor is a nondepleting zirconia solid electrolyte sensor. A small capillary on the sensor controls the diffusion of oxygen into the sensor. When heated to over 400°C oxygen is electronically reduced causing current flow through the zirconia electrolyte. Zirconiumoxide allows the movement of oxygen ions through the substrate from a high to a low concentration. The measurement of oxygen is determined by the current flowing through the electrodes. The zirconia sensor has an unlimited shelf life without the loss of calibration and has an expected life in excess of 5 years. The zirconia sensor is not position sensitive and has low cross sensitivity to other gases and does not dry out.

Low maintenance and cost of ownership

Due to the highly stable nature of the sensor, a calibration interval of once per year is required, allowing for significant cost savings. The construction of our zirconia oxygen sensor means that only 100 mL/min of sample gas is required, providing application flexibility and further potential cost savings.

Fast response time

Zirconia oxygen sensors respond very quickly to oxygen concentrations in both directions with a T90 of less than 10 seconds within a set range.

Electrochemical sensor

The key elements of the electrochemical sensors are a membrane, cathode, anode, electrolyte and measurement circuit. The sensing membrane (covering the cathode) is made of PTFE and is mounted over a metal perforated electrode. The space between the membrane and the electrode is filled either with an aqueous alkaline or an acid electrolyte. In normal operation, all portions of the anode and cathode are immersed in the electrolyte. As oxygen diffuses through the membrane into the electrolyte it causes a reaction between the cathode and anode generating an EMF. This current is proportional to the amount of oxygen present in the sample gas. In the absence of oxygen there is no output from the electrochemical sensor, meaning only one calibration is required.

Quartz Crystal moisture sensor

Quartz crystal microbalance sensor

A quartz crystal is sensitised with a thin film of hygroscopic material. Water molecules are adsorbed into the hygroscopic layer deposited on the surface. The change in mass modifies, in a very precise and repeatable manner, the oscillation frequency. The moisture concentration is measured as a change in the oscillation.

Quartz crystal sensor principle

The change in the oscillation is evaluated by switching the gas inside the sensor and by measuring the response delta. For sampling response, the sensor is balanced between a dry gas source and the sample source. The difference is then calculated. The same principle is applied for the span gas calibration. However, this time the comparison is between a dry gas and a source of wet gas. A cycling time of 30 seconds on each gas is used to compare the response delta.



Quartz crystal module principle

The dry gas comes from a reference gas source. The sensor is supplied by a known Helium or Argon or Nitrogen grade 5.0 carrier source going through a heated gas purifier model LDP1000 series. This combination generates a gas purity of 8N. By using this technique, the dry gas source contains less than 10ppb H₂O what is ideal as zero gas reference. The wet gas comes from a certified water filled permeation tube heated at a controlled temperature of 55 Celsius. It generates a stable amount of moisture used for span calibration. The moisture generator is made of coated stainless steel to reduce the surface absorption of water molecules and then keep the moisture rate very stable and accurate. The flow inside the module is controlled and maintained by a network of calibrated orifices. All flow passageways upfront the sensor are less than 0.030"ID, all coated with an inert coating to accelerate the response/purge time and improve the performances of the system.

INTERNAL FUNCTIONAL DIAGRAM

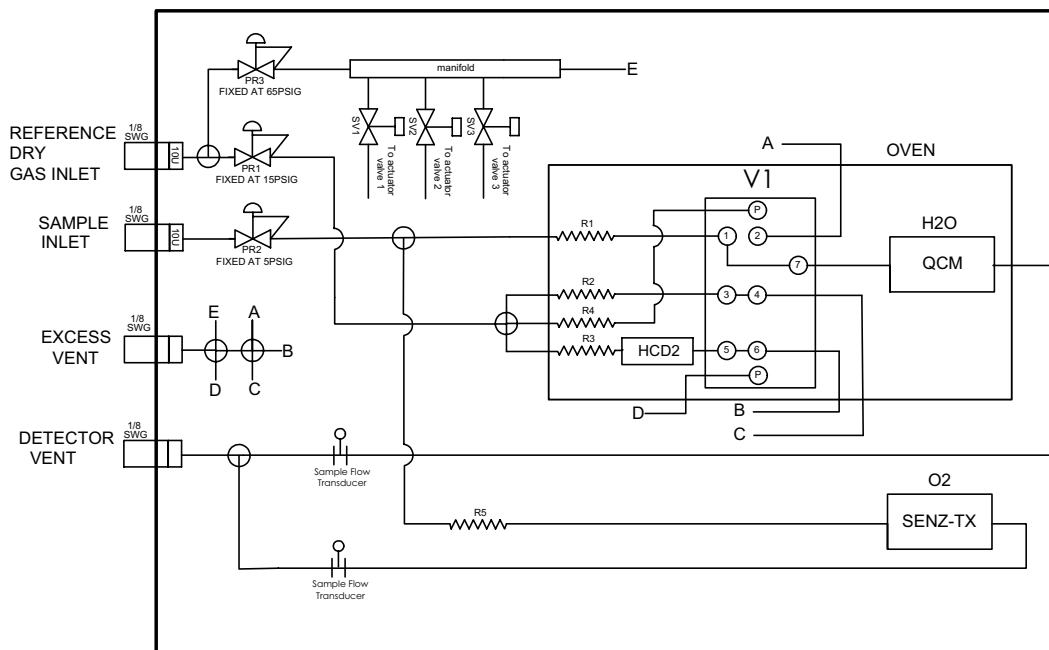

DIMENSIONS:

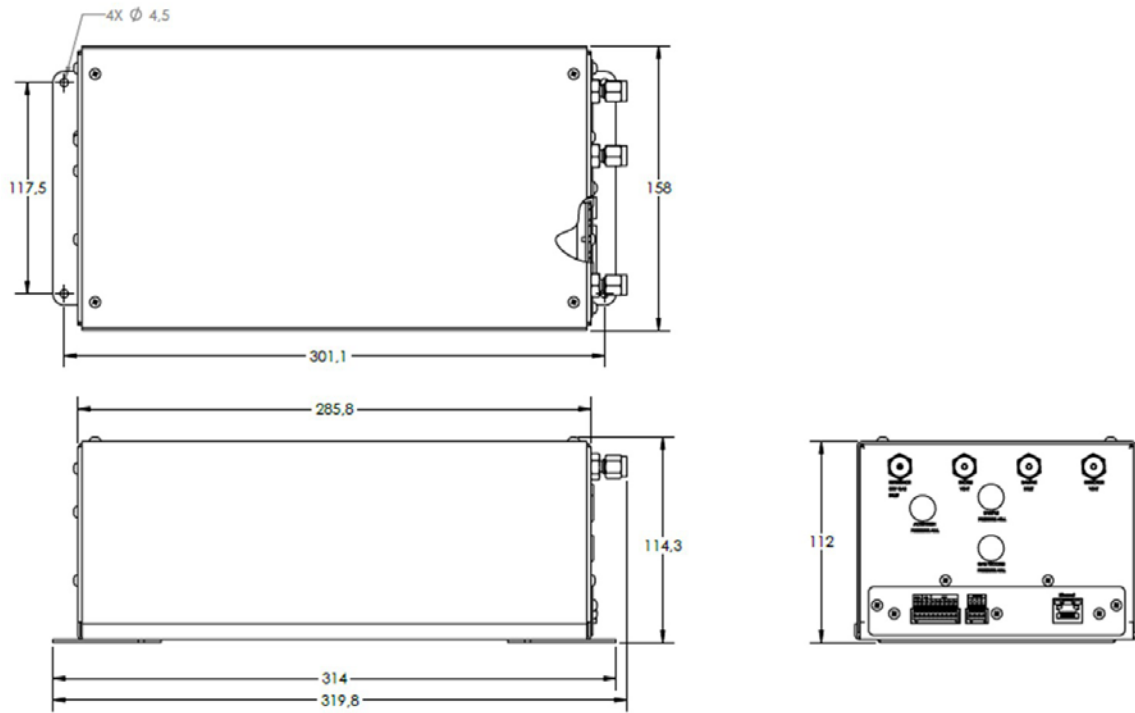

ORDERING INFORMATION:

LDMOX	-XX	-XX	-XX	-XX
	QC: H2O Quartz crystal	EC: O2 electrochemical ZI: O2 zirconia	2S: 1/8" Compression 4S: 1/4" Compression 2FS: 1/8" face seal (VCR) 4FS: 1/4" face seal (VCR)	mA: 4-20mA

LD2000



ONLINE TRACE TOTAL HYDROCARBON ANALYZER



The LD2000 is an easy to use instrument that offers the ideal solution for the total hydrocarbon measurements. Its compact and robust design perfectly fits on any industrial installation. The LDetek FID and electronic platform bring the performances required by the market.

FEATURES:

- LDetek FID design offering low maintenance
- Bootloader integrated for software update via Ethernet
- Large scale measurement
- 4-20 mA output as standard
- Range Identification Relay
- Unique LDetek Electronic flow controller design
- 3U cabinet

APPLICATIONS:

- Air separation unit
- Cryogenic truck loading station
- Speciality gas laboratories
- Process control
- Steel Industries
- Chemical plants
- Welding gas control
- Gas management system
- Quality control for truck fills and gas cylinders
- Safety
- Product validation
- Scrubber & oxidizer efficiency
- Carbon bed breakthrough detection
- Well logging
- Industrial hygiene & safety monitoring
- Fence line (perimeter) monitoring around industrial sites
- CEMS (continuous emission monitoring systems)

SPECIFICATIONS:

DETECTOR TYPE	Flame Ionisation Detector
RANGE	0-10 ppm 0-100 ppm 0-1000 ppm other range possible
REPEATABILITY	< 1% full scale
ACCURACY	Better than $\pm 1\%$ full scale
STANDARD FEATURES	<ul style="list-style-type: none"> • Manual or autoranging (user selectable) • Microprocessor controlled • 5.6" TFT intelligent LCD module with Touch Screen • Self diagnosis system with auto-resolve alarm • 4-20 mA isolated output • Alarm Historic • Digital outputs for remote monitoring: (all dry relay contacts) <ul style="list-style-type: none"> - System status (1 output) - Range in use (3 output) - Calibration in use (1 output)
OPTIONS	<ul style="list-style-type: none"> • Serial port: RS-232 / 422 / 485 / Profibus • 2 alarm outputs (user programmable set point)
GAS CONNECTIONS	Sample: 1/8" compression fittings Vent: 1/8" compression fitting
CALIBRATION GAS	Zero: LDP1000 purified gas (Getter) Span: 80%-90% of full scale of methane
SAMPLE FLOW REQUIREMENTS	50 to 200 sccm
AIR FLOW REQUIREMENTS	200 to 600 sccm
FUEL FLOW REQUIREMENTS	40 to 150 sccm
RECOMMENDED MAXIMUM OPERATING PRESSURE	40 PSIG
RECOMMENDED MINIMUM OPERATING PRESSURE	10 PSIG
OPERATING TEMPERATURE	10 °C to 45 °C
SUPPLY	115 VAC 50 - 60 Hz or 220 VAC 50 - 60 Hz
POWER CONSUMPTION	Maximum 50 watts
DRIFT	< $\pm 1\%$ over 24 hours
WEIGHT	27 lbs (12 kg)

ORDERING INFORMATION:

LD2000	-X	-XXX	-X	-XXX
	Ar: Argon H: Helium O: Oxygen N: Nitrogen A: Air	Operating Voltage: 120: 120 volts 220: 220 volts	A: Alarm option	Serial communication RS2: RS-232 RS4: RS-485 PFB: Profibus

DIMENSIONS:

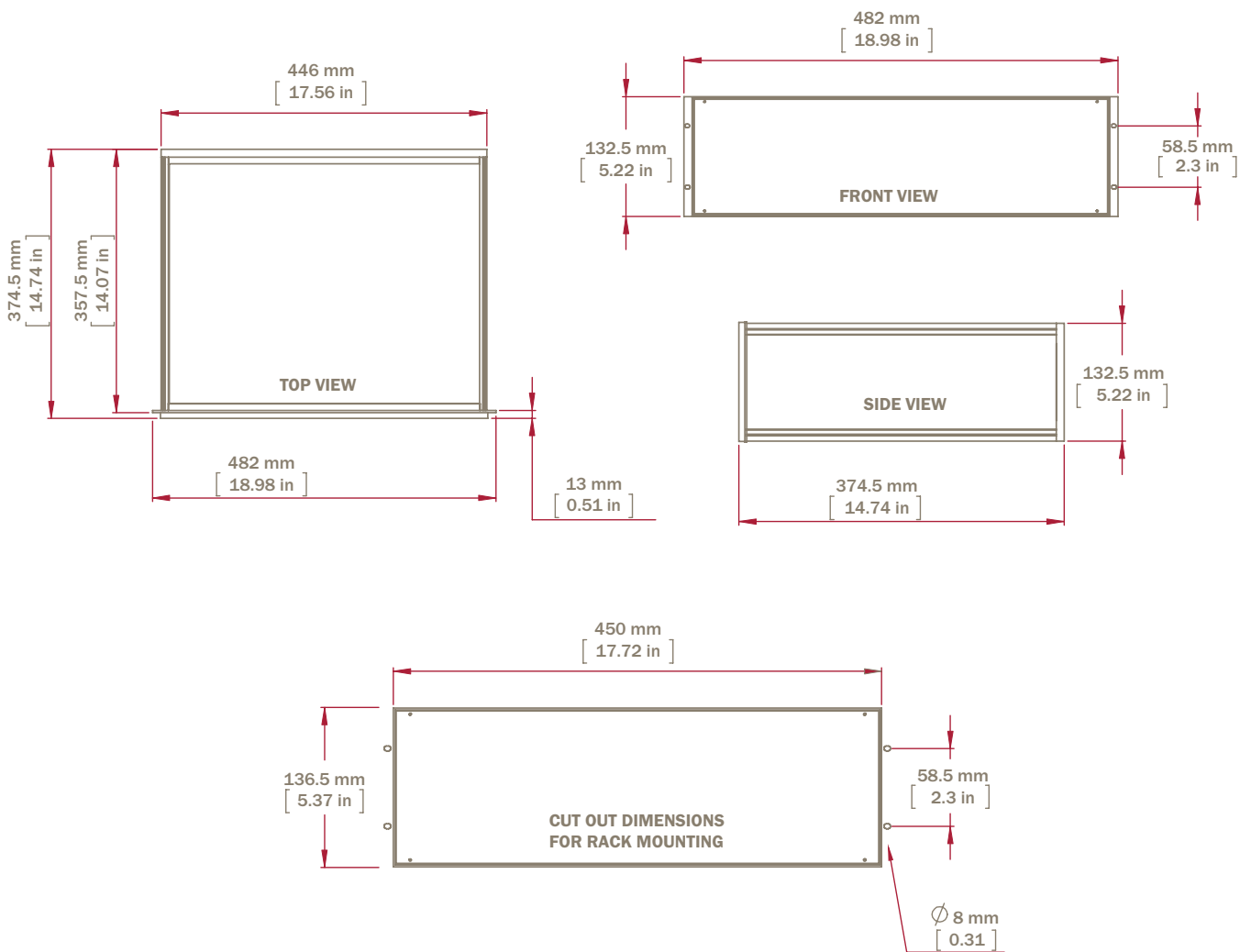

LDP1000 SERIES



GAS PURIFIER COMPATIBLE WITH ANY TRACE GAS ANALYSIS SYSTEM

The LDP1000 series is a sub ppb purifier used for generating high purity calibration gas for online analyzers as well as generating high purity carrier gas for gas chromatograph.

Designed with two steps of purification, this purifier design ensures no undesired impurity is released during process.

WHY CHOOSING LDP1000 SERIES ?

- **2 beds of purification**
Allows perfect purification
- **RS-232 port**
Monitor the temperature of the 2 beds of purification
- **LEDs indication**
Self-diagnostic and status of the purifier
- **Cost effective solution for long-term use**
Interchangeable getter
- **Available in different format**
Compact version makes it ideal when space is limited
- **Real end of life monitoring**
Combined with PED technology and MultiDetek series, LDP1000 series gas purity can be monitored in real time to offer real auto diagnostic.



SPECIFICATIONS:

GETTER TYPE	Alloy of Zr/V/Fe 2 beds (350 and 200 Celsius)				
GASES PURIFIED	Noble gases	Nitrogen	Hydrogen	Carbon dioxide	Oxygen
IMPURITIES REMOVED AT ROOM TEMPERATURE	H2O, O2, CO, CO2, H2	n/a	n/a	H2O, O2, THC	H2, H2O, CO, CO2, CH4, NMHC
IMPURITIES REMOVED WITH HEATED DUAL BEDS	H2O, O2, CO, CO2, N2, NMHC, H2, CH4	H2O, O2, CO, CO2, NMHC, H2, CH4	H2O, O2, CO, CO2, N2, THC	n/a	n/a
REGENERATION MODE ACTIVE	n/a	n/a	n/a	available	available
IMPURITY LEVEL	<10 ppb and <1 ppb available				
FLOW	Compact & LDP1000 versions flow rate are 0.2LPM nominal to 1LPM maximal Large LDP1000 version flow rate is 2LPM nominal to 10LPM maximal				
GAS CONNECTIONS	1/8" - 1/4" compression or VCR®				
RECOMMENDED OPERATING PRESSURE	100 PSIG (689 kPAG)				
SUPPLY	120 VAC, 50 - 60 Hz or 220 VAC, 50 - 60 Hz				
POWER CONSUMPTION	Start-up : maximum 200 Watts (allows quick start-up) Normal operation : maximum 50 Watts (designed for low consumption)				
WEIGHT	8 lbs (3.63 kg) Large LDP1000 • 5 lbs (2.26 kg) LDP1000 • 2 lbs (0.90 kg) Compact-LDP1000				

CERTIFICATION:

CE In compliance with EMC directive 2004/108/EC, EN 61000-6-2:2005 for immunity & EN 61000-6-4:2007 for emissions.

ORDERING INFORMATION:

LDP1000, LARGE LDP1000, COMPACT LDP1000, GETTER LDP1000 OR MINI LDP1000	-XXX	-X	-X	-X	-X
	Operating Voltage: 120 volts (-120) 220 volts (-220)	Gas type: N: Noble gases N2: Nitrogen version H2: Hydrogen O2: Oxygen CO2: Carbon dioxide	Connection size: 1/8" 1/4"	Connection Type: Compression (-C) VCR (-V)	Supporting plate: P-1/8C: Stainless steel supporting plate/ 1/8" compression with high purity bypass valve & 2 in/out isolation valves P-1/8V: Stainless steel supporting plate/ 1/8" VCR with high purity bypass valve & 2 in/out isolation valves P-1/4C: Stainless steel supporting plate/ 1/4" compression with high purity bypass valve & 2 in/out isolation valves P-1/4V: Stainless steel supporting plate/ 1/4" VCR with high purity bypass valve & 2 in/out isolation valves None: no plate

DIMENSIONS LDP1000:

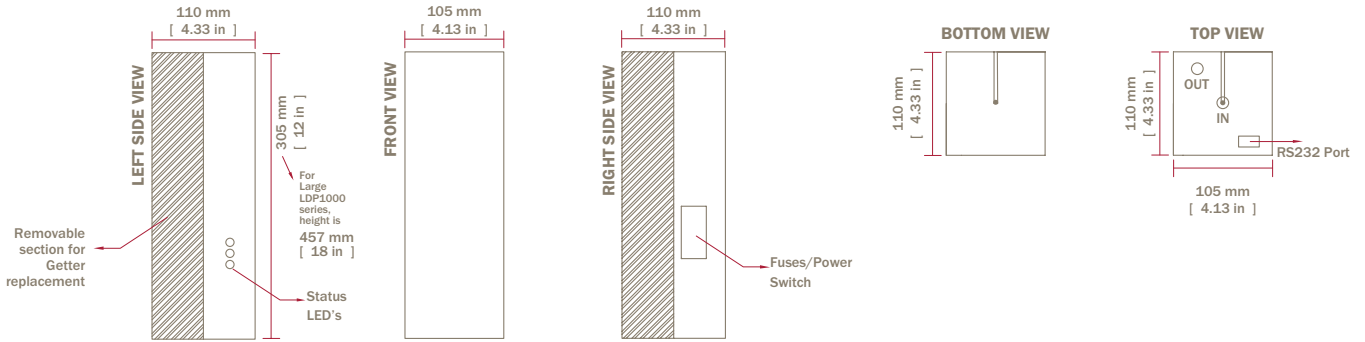

DIMENSIONS COMPACT-LDP1000:

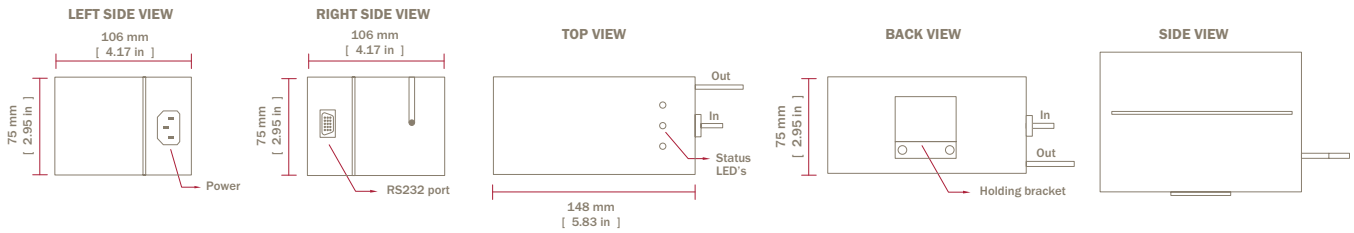

DIMENSIONS FOR THE OPTIONAL STAINLESS STEEL SUPPORTING PLATE WITH BYPASS AND IN/OUT ISOLATION VALVES:

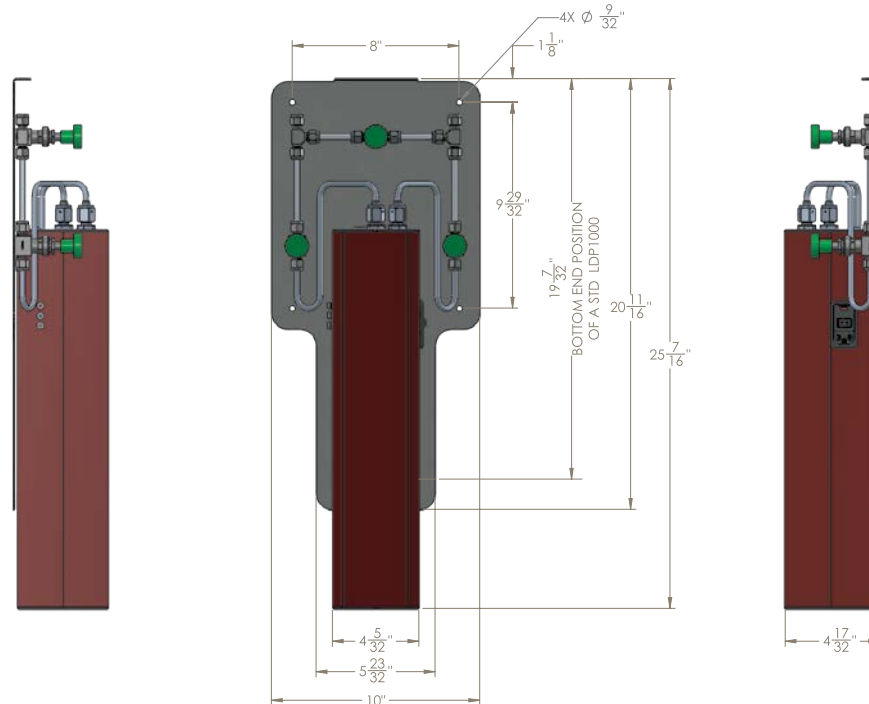

LDP2000



HIGH FLOW DUAL GETTERS GAS PURIFIER SERIES



The LDP2000 series is a sub ppb purifier used for generating high purity calibration gas for online analyzers as well as generating high purity carrier gas for gas chromatograph system. Designed with its temperature controlled two steps of purification, this purifier series ensures to generate grade 9.0 (99.9999999%) purity at its outlet.

Its dual getters automatic switching allows this series to feed up multiple instruments with a single source without interruption.

FEATURES

- High flows up to 20LPM to feed multiple analytical instruments
- Two getters mounted in parallel with automatic switching via a network of pneumatic valves in case of purity level alarm to avoid flow interruption
- Realtime gas quality monitoring with a mini-PED (plasma emission detector) integrated in the device to monitor trace N₂ and H₂O at the outlet of the purifier (Optional)
- Purity level and status alarms
- Regeneration mode pre-programmed and available
- Serial Port
- Diagnostic LCD and its keypad
- Indication LEDs
- Interchangeable getter

SPECIFICATIONS

GETTER TYPE	Combination of different alloy of Zr/V/Fe/Pd with 2 beds of purification				
GASES PURIFIED	Noble gases	Nitrogen	Hydrogen	Carbon dioxide	Oxygen
IMPURITIES REMOVED AT ROOM TEMPERATURE	H2O,O2,CO,CO2,H2			H2O,O2,THC	H2,H2O,CO,CO2, CH4,NMHC
IMPURITIES REMOVED WHEN DUAL BEDS ARE HEATED	H2O,O2,CO,CO2,N2,NMHC, H2, CH4	H2O,O2,CO,CO2,NMHC, H2, CH4	H2O,O2,CO,CO2,N2, THC	n/a	n/a
REGENERATION MODE AVAILABLE	n/a	n/a	n/a	Yes	Yes
REAL TIME MONITORING TRACE N2-H2O WITH PED AVAILABLE	Yes	n/a	n/a	n/a	n/a
IMPURITY LEVEL AT OUTLET	<1ppb				
FLOW	2LPM nominal up to 20LPM maximum				
GAS CONNECTIONS	1/4" VCR				
RECOMMENDED OPERATING INLET PRESSURE RANGE	50psig-200psig (345kpag-1379kpag)				
ELECTRICAL SUPPLY	110/120VAC 50/60Hz or 220/240VAC 50/60Hz				
POWER CONSUMPTION	At Start up: 300 Watts max, at Normal operation: 200 Watts max				
WEIGHT	35LBS (15.9KGS)				

CERTIFICATIONS

CE & UKCA In compliance with EMC directive IEC 61000-6-2: 2016 (immunity) & IEC 61000-6-4: 2018 (emission) for equipment used in industrial environment.

DIMENSIONS

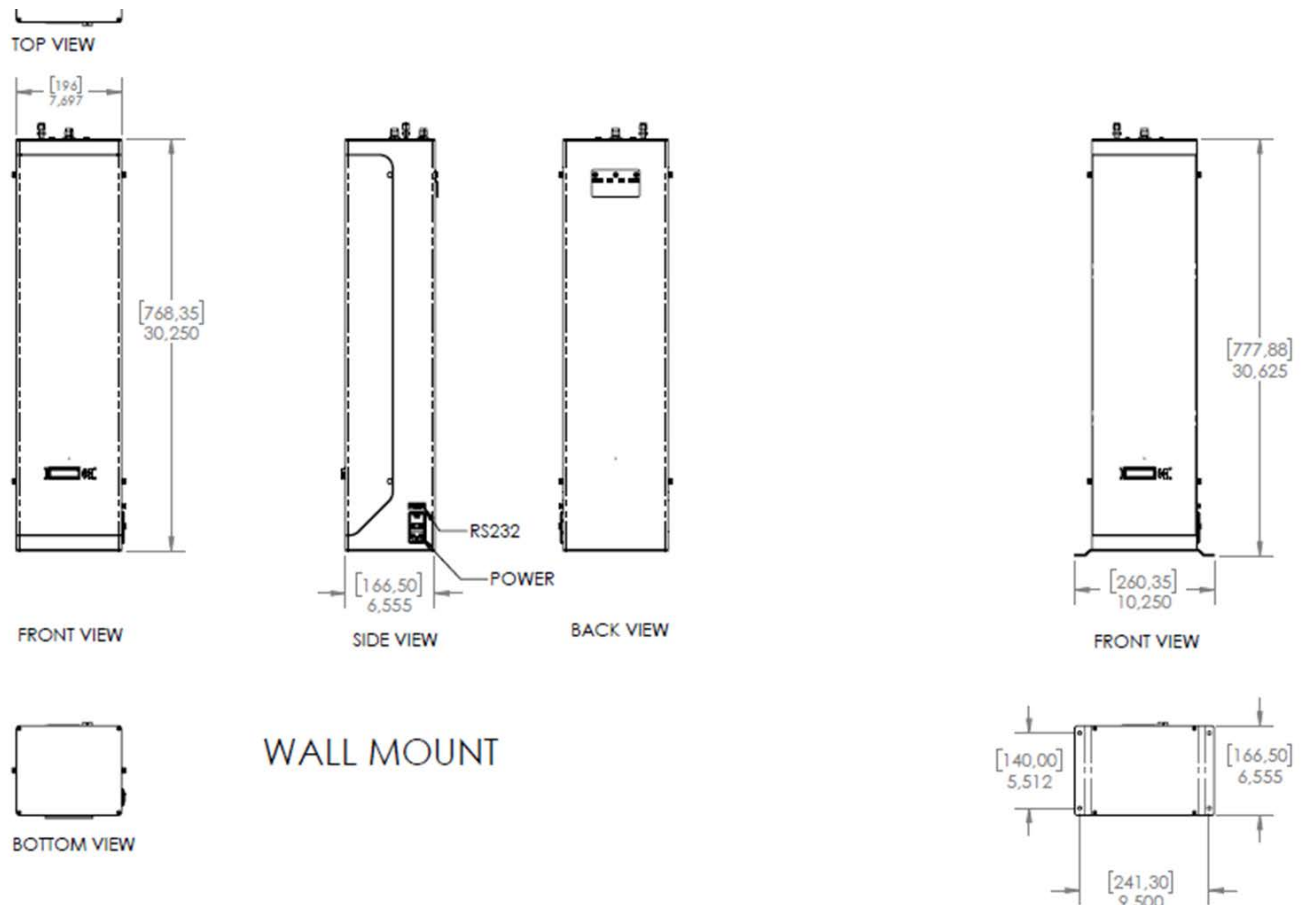

TYPICAL INSTALLATION AND OPERATIONS

The LDP2000 dual getters large gas purifier system is designed to feed the carrier gas of multiple analytical instruments. Having only one purification device to feed multiple instruments simplify the operations and the maintenance/installation costs.

With our mini plasma emission detector mounted at the outlet of the purifier to trace ppb N₂ and H₂O impurities in Helium or Argon mode, it offers the online monitoring of the real gas quality generated. If the purity level alarm is activated due to trace impurities measured, the device automatically switches to the spare getter to keep feeding the analytical instruments without interruption. The saturated getter is then cooled down and isolated to allow the replacement of it easily.

The device has a front LCD with keypad to navigate through its interface.

The schematic represents a typical gas chromatograph installation having multiple GCs. A switchover system (LDASS) with a pressure monitoring system (LDPMS) are used to secure the bottle pressure monitoring before the LDP2000 gas purifier. At the outlet of the LDP2000 gas purifier, our cryogenic purification system (LDCRYO) is mounted to remove the trace impurity Argon presents in Helium source. The combination of the 3 systems together is the best solution to feed high quality gas to any gas chromatography systems.

Automatic switchover system LDASS + LDPMS pressure monitoring system & alarms

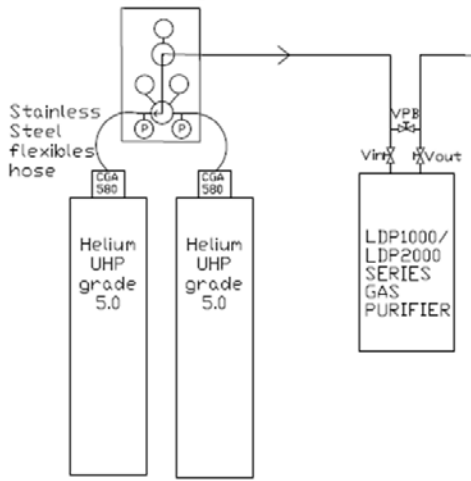

Cryogenic dual trap system for carrier gas purification LDCryo + LDPMS pressure monitoring system & alarms

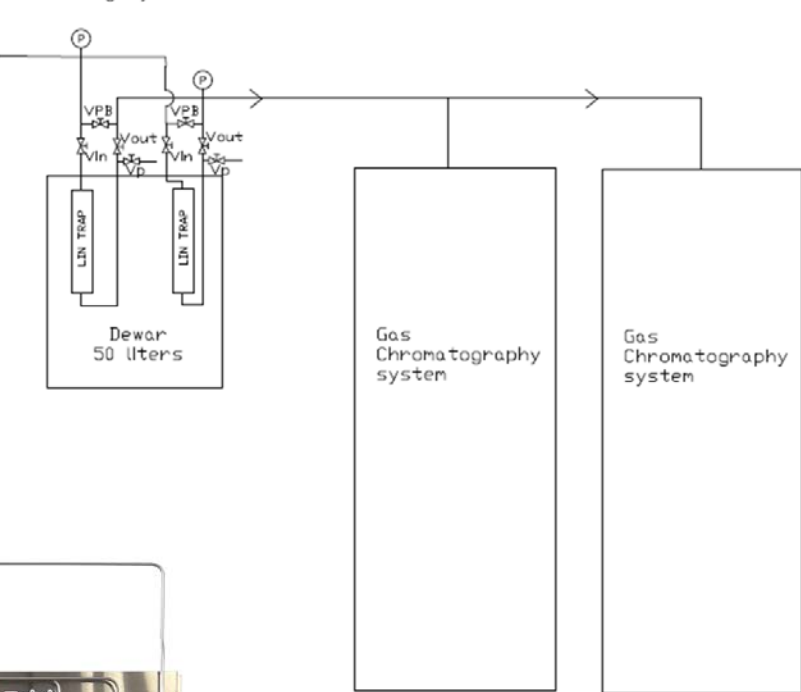

MOUNTING PLATE OPTIONS

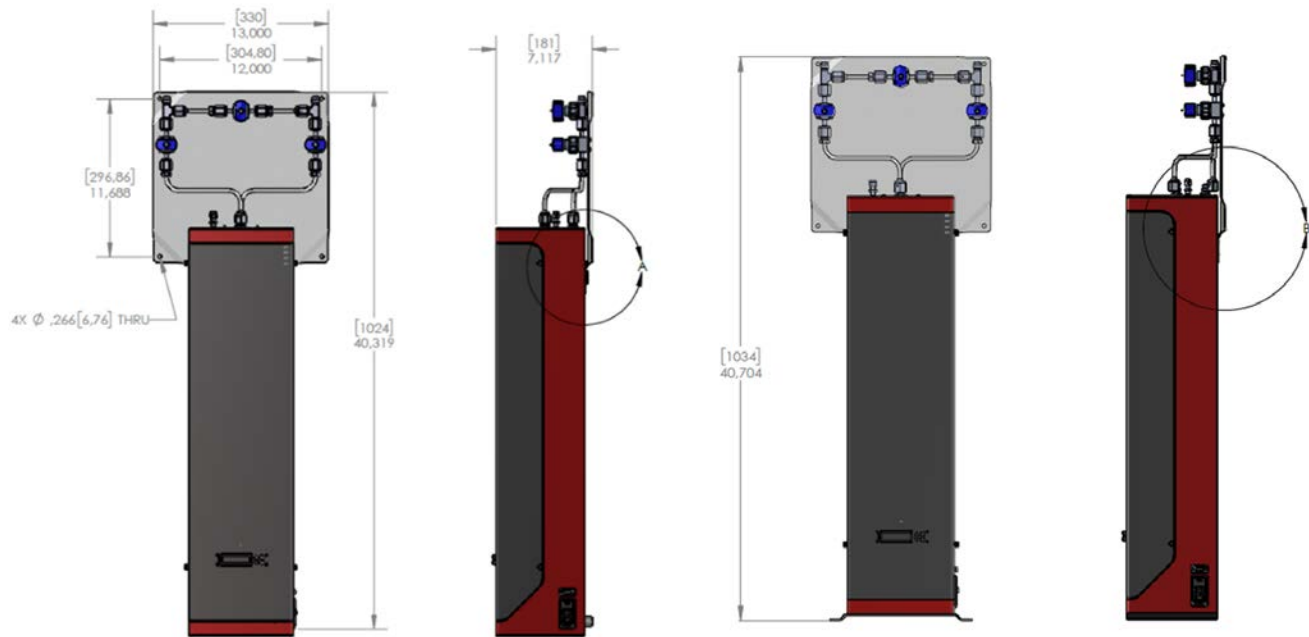

WALL MOUNT

SHELF MOUNT

ORDERING INFORMATION

LDP2000	-XXX	-X	-X	-X	-XX	-XXXX
	Operating Voltage : 120 : 120VAC 240 : 240VAC	Gas type : N : Noble gases N2 : Nitrogen version H2 : Hydrogen O2 : Oxygen CO2 : Carbon dioxide	Gas Connection size : 4 : ¼"	Gas connection type : C : Compression FS : Face seal	Supporting plate: WM : Stainless Steel wall mount SM : Stainless Steel shelf mount	Supporting plate valves config : BP4C : bypass valve only compression ¼" BP104C : bypass & in & out valves compression ¼" BP4FS : bypass valve only face seal ¼" BP104FS : bypass & in & out valves Face Seal ¼"

LDCRYO



CRYOGENIC TRAP SYSTEM FOR GC HELIUM CARRIER GAS PURITY



The LDCryo is a stand-alone system used to generate 99.9999999% Helium purity carrier gas (Argon removal included) when used in combination with our LDP1000/LDP2000 heated gas purifier series. The system includes our pressure monitoring LDPMS device with a purge/bypass valve arrangement. Both, Stainless Steel traps are mounted in parallel in a 50 liters Dewar to ensure rotation and continuous carrier supply without interruption. The complete system is configured with VCR and welded gas connections.

APPLICATIONS

- Semiconductor & electronics gases

SPECIFICATIONS:

PRESSURE SENSOR RANGE	0-200psig (0-25bar)
PRESSURE SENSOR MATERIAL	Stainless Steel with media-isolated metal diaphragm
PRESSURE SENSOR GAS CONNECTION	1/4 NPT
PURGE/ISOLATION/BYPASS VALVES	1/4" VCR (model ¼ turn blue handle)
FLEXIBLE HOSES	Stainless Steel
MOUNTING PLATE	Stainless Steel
GAS INLET PORT	1/4" VCR male
GAS OUTLET PORT	1/4" VCR male
PRESSURE SENSOR RATED	IP65
DEWAR SIZE	50 Liters
MAX FLOW RATE CAPACITY	5LPM (Helium)
LIQUID NITROGEN REFILL REQUIREMENT	4-8 weeks (application dependent)
TRAP LIFETIME (REGENERATION INTERVAL)	3-6 months (application dependent)
RECOMMENDED OPERATING PRESSURE	100PSIG (6.89Bar)

LDPMS MODULE

ACCURACY	+/-0.25% full scale
OPERATING VOLTAGE	85 ~ 264VAC
OPERATING CURRENT	< 0.1A
OPERATING FREQUENCY	50-60Hz
RELAY OUTPUTS (4X)	Dry contact N.O & N.C <ul style="list-style-type: none"> • Relay 1: Status system working • Relay 2: Gas inlet low pressure alarm • Relay 3: Gas outlet low pressure alarm • Relay 4: Inlet & outlet low pressure alarm with buzzer
COMMUNICATION	Serial port RS232 with Modbus RTU (male DB9 connector)
OPERATING TEMPERATURE	-20 °C to 70 °C (-4 °F to 158 °F)
OPERATING TEMPERATURE FOR PRESSURE SENSORS	-40 °C to 125 °C (-40 °F to 257 °F)

DIMENSIONS

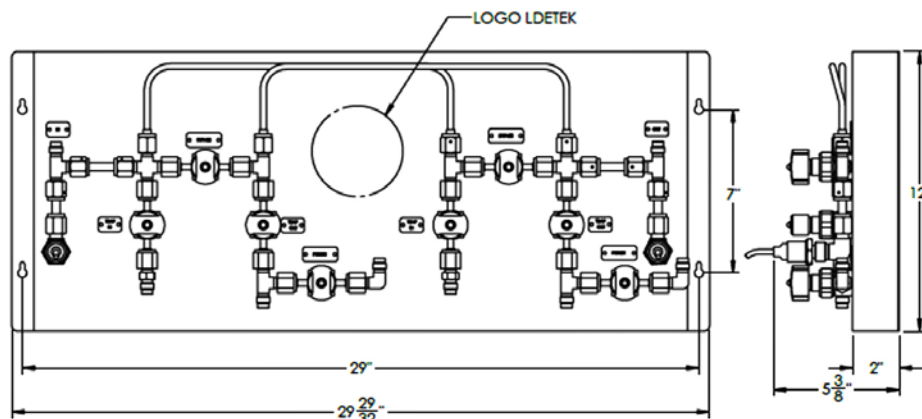

TYPICAL INSTALLATION

The LDCryo system comes with a single trap or with dual trap configuration. In its most common dual trap configuration, both traps are mounted in parallel and can be replaced periodically when the trap is blocked. The LDMPS pressure monitoring system monitor the pressure at its inlet and outlet to ensure the pressure is high enough to feed the gas chromatography system carrier gas. If the pressure comes low, then the LDMPS gives an alarm, and the operator must isolate/regenerate the default trap and open the valves of the backup trap to keep flowing gas through the GC system.

The LDCryo system must be installed with our LDP1000 or LDP2000 heated gas purifier series. The heated gas purifier must be installed before the LDCryo to remove most of the impurities (excluding Argon). This way, it ensures to keep the cold trap system clean from high level contaminants and then ensure its lifetime is extended as long as possible.

The complete system is mounted with the LDASS automatic switchover system to keep the Helium source permanent without interruption.

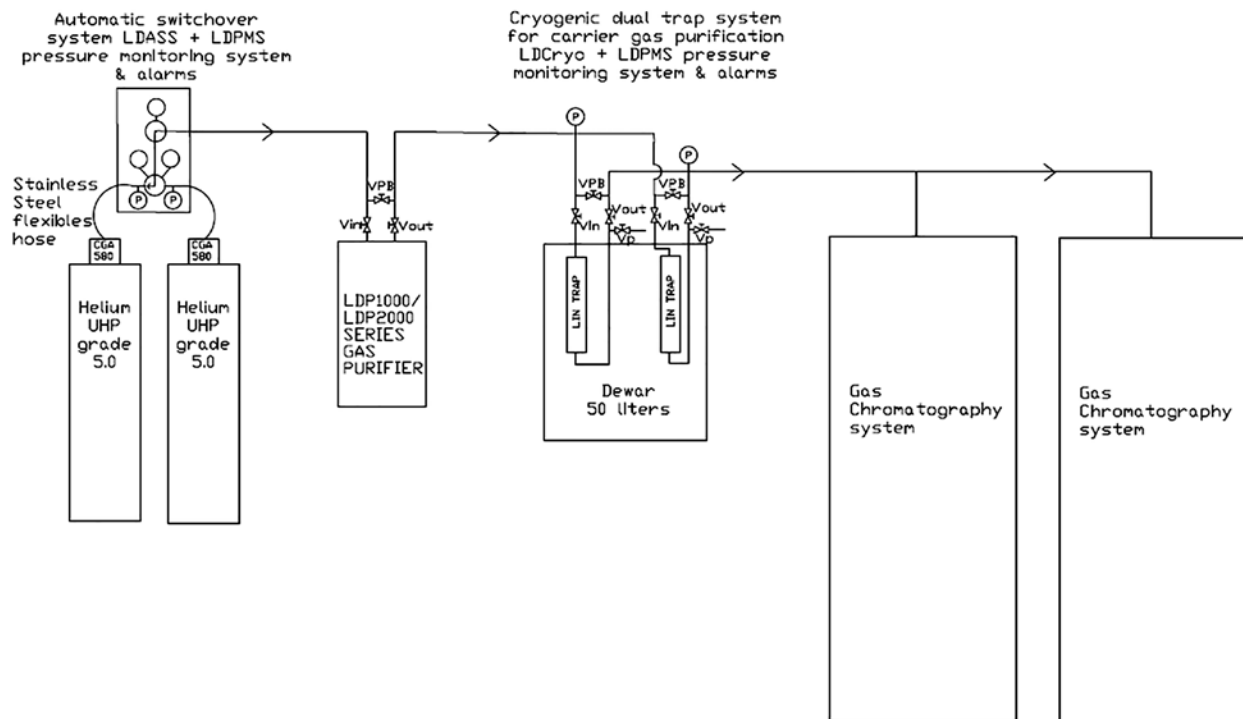

ORDERING INFORMATION

LDCRYO	-X
	S : Single trap D : Dual trap

LDRPS

PST
PROCESS SENSING
TECHNOLOGIES

LDetek
A PST BRAND

GAS RECOVERY AND PURIFICATION SYSTEM



The LDRPS is a fully automatic gas recovery & purification system especially designed to recycle the Helium carrier gas used by any type of gas chromatograph. The system is also compatible with any other type of gas source that must be recycled.

APPLICATIONS

Cost of carrier gas is an important factor when using gas chromatography as analysis instrument for detection of impurities in different UHP gases. Especially Helium carrier gas which is well recognized for its perfect properties used in gas chromatography. Reducing the operation cost becomes an important factor and it is where the LDRPS plays an important role with its quick return in investment by reducing any GC carrier gas consumption.

- Industrial/medical/laboratory
- Gas chromatography/Gas analysis/Gas supply/Gas purification

CONFIGURATION

The module is configured with 5 phases that ensure to recover and purifier the carrier gas required to feed any type of gas chromatographs or gas analysers.

Phase 1: Collecting waste carrier gas from any gas chromatograph exhausts without causing pressure fluctuations or built up.

Phase 2: Building pressure up at the proper pressure requires by the GC inlets

Phase 3: Storing excess gas in reservoir

Phase 4: Purifying from any grade waste gas up to 99.999999% using multi steps heated purifiers system

Phase 5: Measuring trace impurities(ppb/ppm) nitrogen and moisture using a micro plasma detector to validate the purity of the recycled carrier gas prior to return to the gas chromatograph.

Where **innovation** leads to **success**

www.ldetek.com

SPECIFICATIONS

OPERATING TEMPERATURE RANGE	5-55 Celsius
SAMPLE GAS TEMPERATURE	0-100 Celsius
RECYCLING GAS FLOW RATE CAPACITY	0-5LPM
GAS COLLECTING PRESSURE RANGE	0-20PSIG (sub atmospheric available)
OUTLET PRESSURE	20-110PSIG (other pressure ranges available on request)
INLET FITTINGS	1/8" or 1/4" Swagelok compression or VCR
OUTLET FITTINGS	1/8" or 1/4" Swagelok compression or VCR
STANDARD FEATURES	Modbus, Web interface(admin)
SUPPLY	120VAC/240VAC 50/60Hz

DETECTION TECHNOLOGY FOR CONTINUOUS PURITY ANALYSIS

PLASMA EMISSION DETECTOR

Plasma emission detector

It is used to measure trace impurities nitrogen & moisture after the completion of the recycling and purification phases.

Plasma emission detector principle

The PED uses Helium or Argon or other noble gases as discharge gas in a sealed quartz chamber dedicated for measuring trace nitrogen and trace moisture at its specific wavelength. Both impurities are measured continuously through a quartz window that allows the light generated by the passage of nitrogen and moisture in the quartz chamber to be measured with its proper optical design.

Plasma emission module principle

The module is calibrated using a zero reference and a span reference. In instance, the zero comes from a grade 99.999% Argon or Helium that goes in our LDP1000 purifier series to generate grade 99.999999%. Going that way, it ensures the zero gas is well referenced to avoid negative reading. A second source of gas named span gas is used for the nitrogen span reference of the sensor. In this case, a certified gas containing a known concentration of N₂ in a balance Argon or Helium is then required. The module is then calibrated, accurate and linear within its operating range. The moisture is calibrated using an internal certified permeation tube as reference.

Fast response time

Plasma emission detector responds very quickly to nitrogen and moisture concentrations with a T₉₀ of less than 10 seconds within a set range.



DIMENSIONS

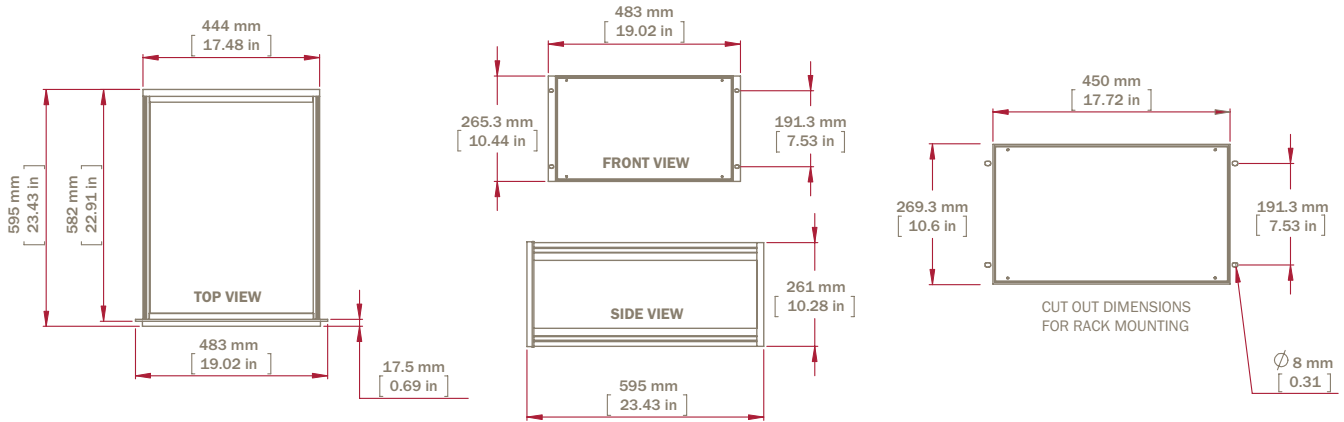

ORDERING INFORMATION

LDRPS	-XX	-XX	-XXX	-X
	He : Helium Ar : Argon Kr : Krypton Xe : Xenon Ne : Neon	2S : 1/8" Compression 4S : 1/4" Compression 2FS : 1/8" face seal (VCR) 4FS : 1/4" face seal (VCR)	PED : plasma emission for N2 & H2O	P : Purifier

MOISTURE & HYDROCARBONS TRAPS SERIES

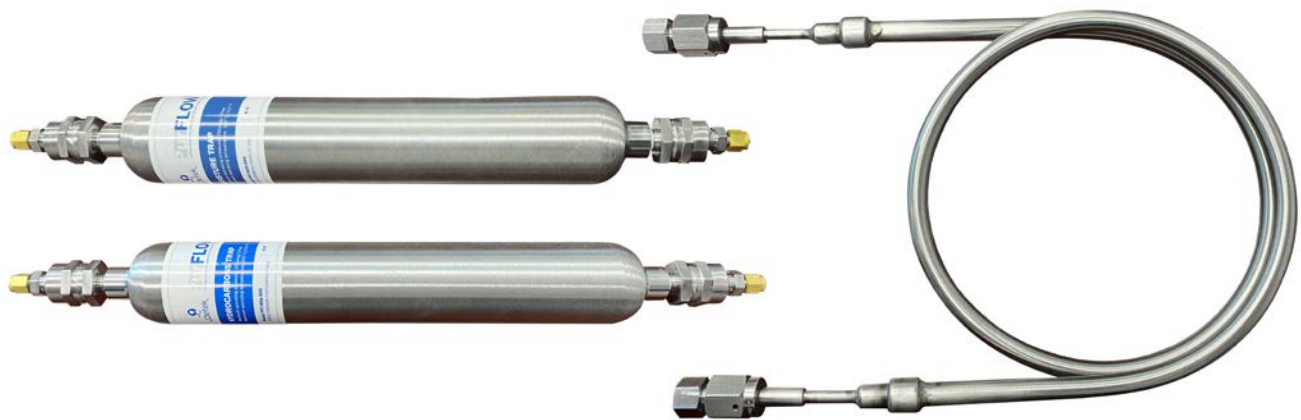

High capacity & purity traps. All Stainless Steel made of; this series offers the best performances for ultra high purity gas applications. Perfectly suitable for bulk purification applications or where several instruments are plumbed from a single gas source.

Having 15 microns, 1 inch diameter particle filter, this 316 Stainless Steel all-welded-in-line filters installed on the inlet/outlet ensures to minimize the restriction to the passage of high flow rate and keeping the particles away from the analytical instruments.

By default, the inlet/outlet fittings are 1/8" Stainless Steel compression type, but other sizes/types can be made on request.

The traps having more than 300cc volume offers refillable capability. The small 50cc volume trap version offers regeneration possibility.

MOISTURE TRAPS SERIES

Material: 4A/13X Molecular Sieve



Part Number	*Moisture Capacity (grams)	Max Flow Rate (SLP)**	Dimensions inches(cm)	Volume (cc)
LDT-H2O-50 (old LD-H2O-T)	10	0.2	Length: 10" (25cm) Diameter: 3/8" (1cm)	50
LDT-H2O-300	40	1	Length: 15" (38cm) Diameter: 2" (5cm)	300
LDT-H2O-500	75	2	Length: 19" (48cm) Diameter: 2" (5cm)	500
LDT-H2O-1000	150	5	Length: 16" (41cm) Diameter: 3.5" (9cm)	1000

* Moisture capacity is based at 25 °C/77 °F

** Reduce H2O to ≤ 5ppb

Trap regeneration or refill is 165,00USD (P/N: LDT-refill or LDT-regen)

HYDROCARBONS TRAPS SERIES

Material: Activated Charcoal



Part Number	*Hydrocarbons Capacity (grams)	Max Flow Rate (SLP)**	Dimensions inches (cm)	Volume (cc)
LDT-HCs-50 (old LD-HC-T)	10	0.2	Length: 10" (25cm) Diameter: 3/8" (1cm)	50
LDT-HCs-300	40	1	Length: 15" (38cm) Diameter: 2" (5cm)	300
LDT-HCs-500	60	2	Length: 19" (48cm) Diameter: 2" (5cm)	500
LDT-HCs-1000	120	5	Length: 16" (41cm) Diameter: 3.5" (9cm)	1000

* Capacity is based at 25 °C/77 °F

** Reduce total hydrocarbons (except CH4) to ≤ 10ppb

Trap regeneration or refill is 165,00USD (P/N: LDT-refill or LDT-regen)

Where innovation leads to success

www.ldetek.com

OXYGEN TRAPS SERIES

Material: Activated R3-11 Copper catalyst

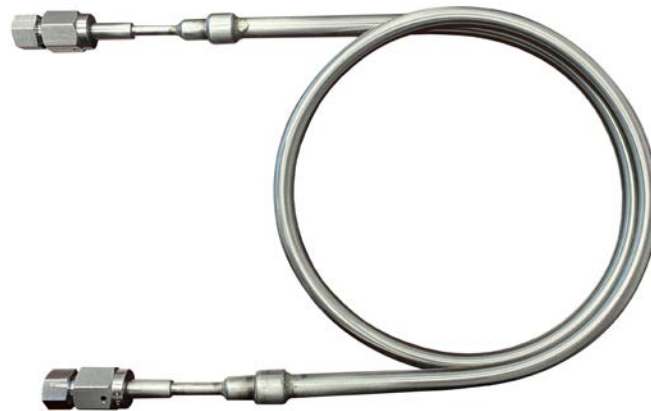

Part Number	*Oxygen Capacity (grams)	Max Flow Rate (SLP)**	Dimensions	Volume (cc)
LDT-02-50 -VCR-1/8 (old LD-02-T-VCR-1/8)	100	0.2	Length coil: 48" Diameter coil: 5" Diameter tube : 1/4"	50

* Capacity is based at 25°C/77°F

** Reduce Oxygen to ≤ 5ppb

Trap regeneration is 165,00USD (P/N: LDT-regen)

SYSTEM INTEGRATION INTO 19" RACKMOUNT CABINETS SEMICONDUCTOR & INDUSTRIAL GASES APPLICATIONS

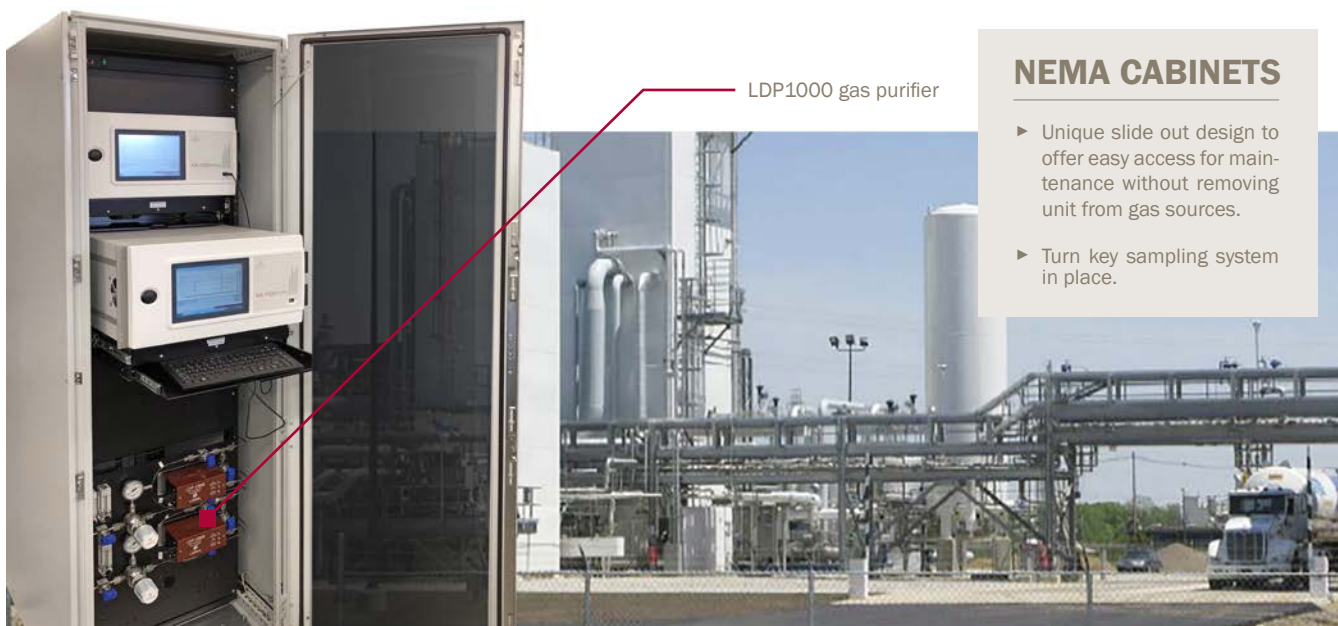
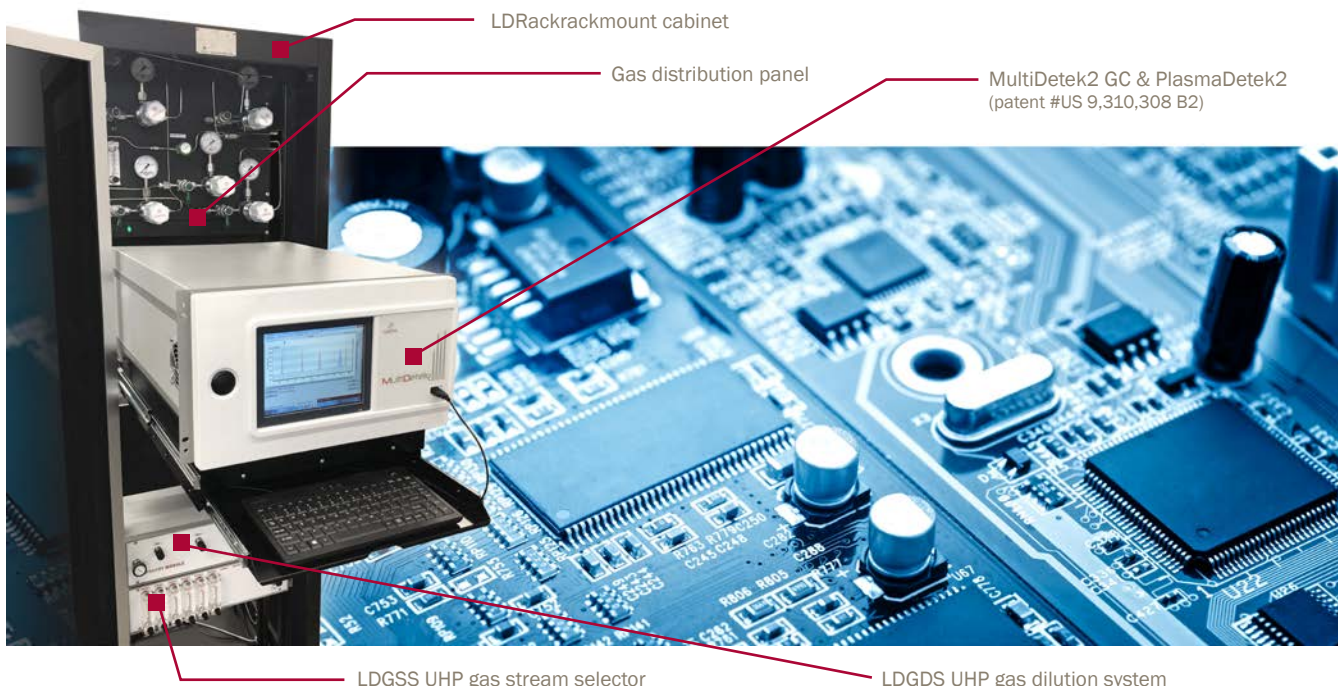

NEMA CABINETS

- ▶ Unique slide out design to offer easy access for maintenance without removing unit from gas sources.
- ▶ Turn key sampling system in place.

2.0 PRODUCTS



Different rackmount enclosures available for indoor or outdoor installations with different options:

- ▶ Close or open frame
- ▶ Steel cabinet
- ▶ Stainless Steel 304/316
- ▶ AC system
- ▶ Heating system with isolation
- ▶ Orbital welding
- ▶ Third party integration

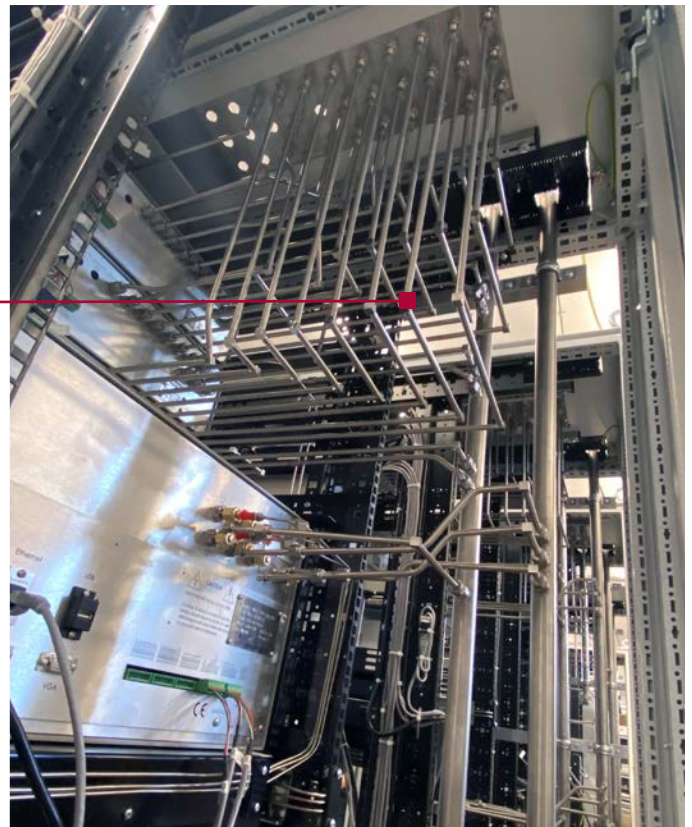
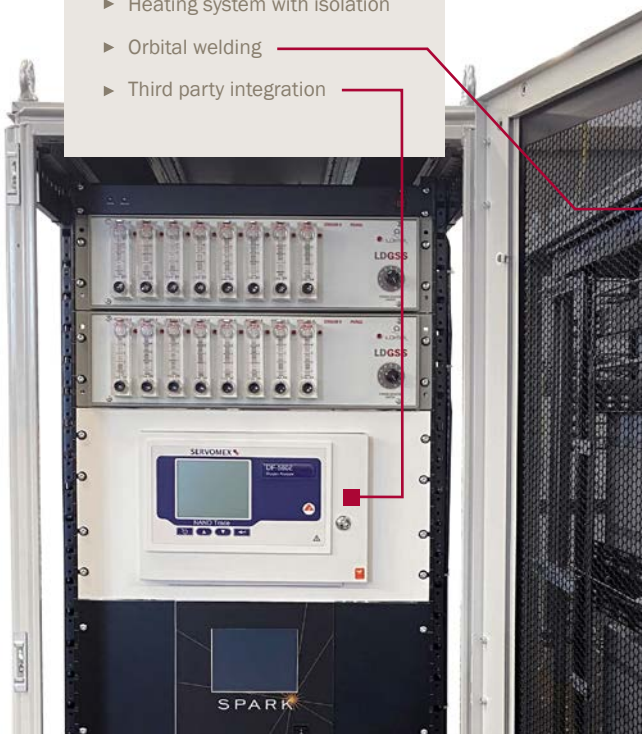

LDportable



LDetek also offers a portable solution for gas analysis. Its robust transportable rackmount enclosure with carrying handles and wheels is the perfect solution when moving the analyser to different locations is required.



The system allows quick starting mode by having the LDP1000 series integrated gas purifier for carrier and reference gas integrity in place. High purity isolation valves are also mounted to isolate the system against air contamination during transportation. All gas connections are mounted on the back plate for an easy and quick access.



A stream selection system and gas regulators can be mounted on the front panel for proper sample regulation before entering into the analyser.

Gas chromatograph or online gas analyser can be integrated in our solution easily. Our analyser design with its front door gives a full access to inside the instrument easily. An integrated touchscreen interface and PC allows direct access to data. A remote access is also available in all our instruments.

Anti vibration protection system is in place in each corner to minimize the vibrations and reduce the risk to damage the system during transportation.

ORDERING INFORMATION:

LDRack	-XXX	-X	-X	-X	-XXX	-XXXX	-XXXX	-XX	-XXX
	Operating Voltage: 120 : 120 volts 220: 220 volts	Cabinet Brand: R: Rittal B: Bud P: Pellican H: Hammond	# of streams: 1-20	Isolation valves (3x) for LDP1000 purifier: 1-3	Analyzer mounted on slide out system: 1SO: 1 unit 2SO: 2 units 3SO: 3 units	Inlet Fittings: 2C: 1/8" compression 4SWG: 1/4" compression 2VCR: 1/8" VCR 4VCR: 1/4" VCR	Outlet Fittings: 2C: 1/8" compression 4C: 1/4" compression 2VCR: 1/8" VCR 4VCR: 1/4" VCR 1NPT: 1" NPT manifold pipe 1CP: 1" compression manifold pipe	Heating and cooling system: AC: air conditioning HI: heating and isolation	Additional options: OW: Orbital welding TPA: third party analyser installed TEB: Eyes bolt for lift transport GFD: Glass front door BMD: Back metal door FBD: Fan mounted on back door UPS: UPS battery backup TW: transport wheels H2E: H2 exhaust H2V: H2 safety shutoff valve LEL: LEL hazardous gas sensor

CABINET TYPE:

	A/C	Heated/ Isolated	Size 42U	Size 38U	Size 30U	Size 9U	Plastic	Steel	316L SS	304 SS	Color Black	Color Light gray RAL7035	Rackmount 19"	Portable	IP66	Nema 12	Nema 4X	Outside installation (-30C to +40C)
Rittal	✓		✓	✓				✓		✓		✓	✓		✓	✓	✓	
Bud					✓			✓			✓		✓					
Hammond	✓	✓	✓					✓	✓	✓		✓	✓		✓	✓	✓	✓
Pellican						✓	✓				✓		✓	✓				

DIMENSIONS:

Rittal 38U

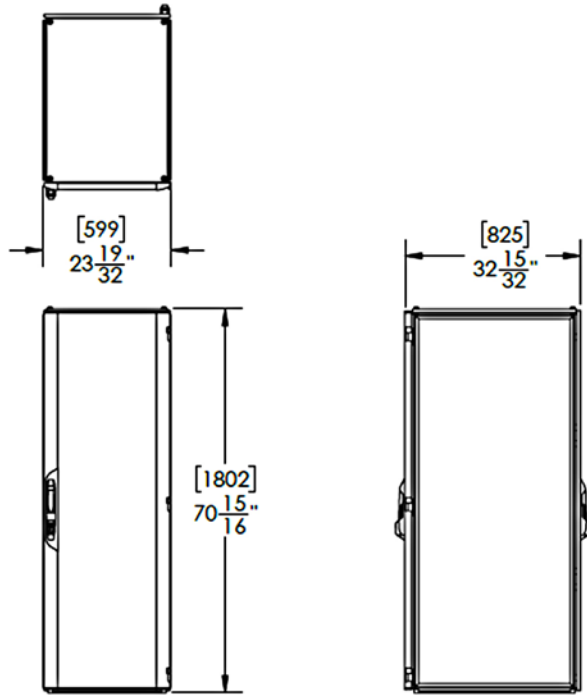

Rittal 42U

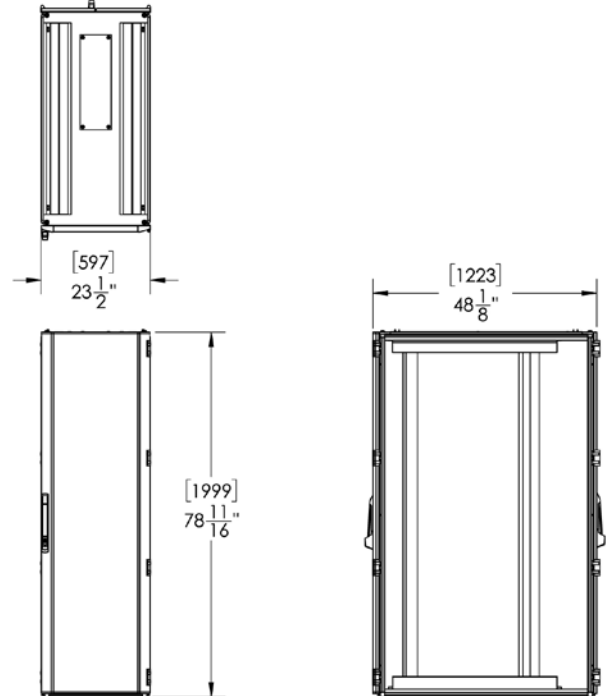

Hammond 42U

Stainless steel (with AC & heating) for outside installation

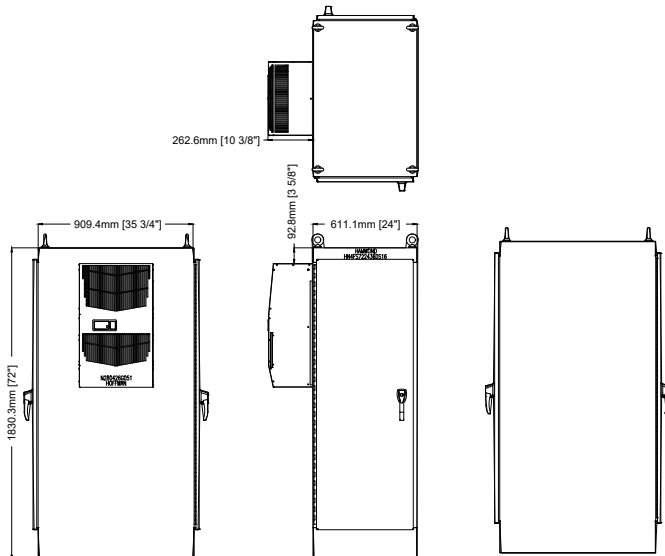

Bud 30U

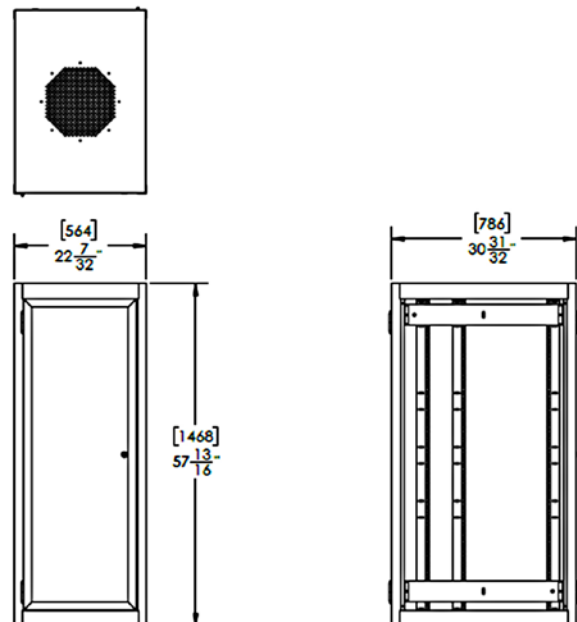

APPLICATION NOTE

LD23-05



Turnkey solution for ASU gas producers and SEMI applications

LDGSS gas stream selector using diaphragm stainless steel valves for ultra high purity streams

MultiDetek3 gas chromatograph configured with plasma emission detector for part per billion detections



LDGDSA gas dilution system for generating ppb calibration mixtures

LDP1000 gas purifier series used to generate grade 99.9999999% purity carrier gas to ensure low ppb detection

2.0 PRODUCTS

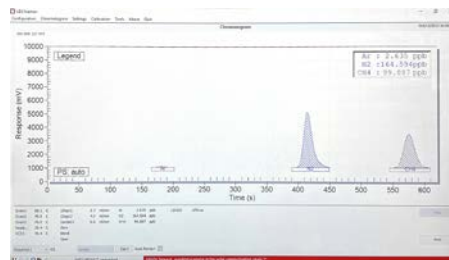
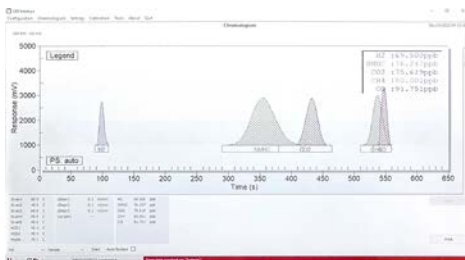

Chromatograms for trace impurities H₂-O₂-Ar-N₂-CH₄-CO-CO₂-NMHC in bulk gases Oxygen/Nitrogen used for semiconductor application. The MultiDetek3 gas chromatographs are configured with PED and proper columns to measure within a range of 0-100ppb with a limit of detection set at 0.5 ppb.

Where innovation leads to success

www.ldetek.com

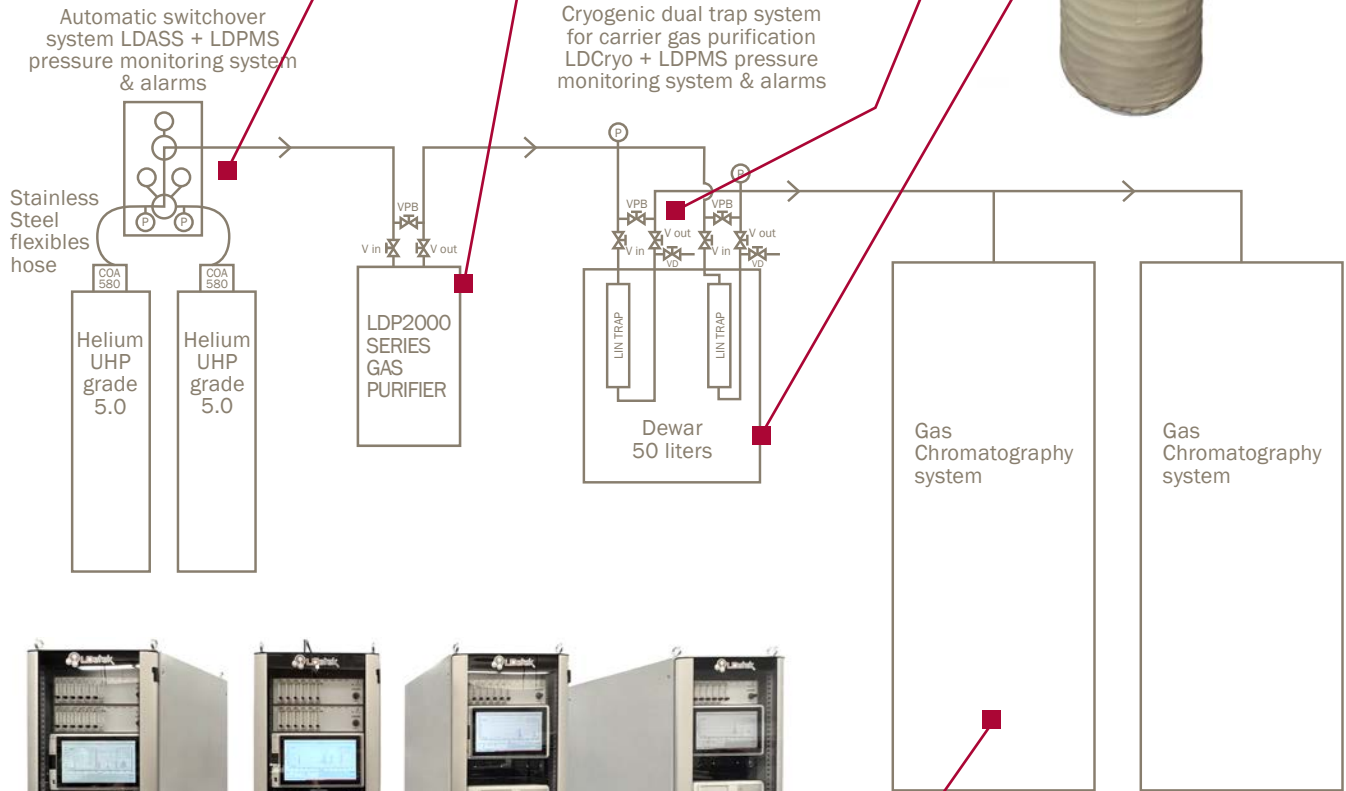
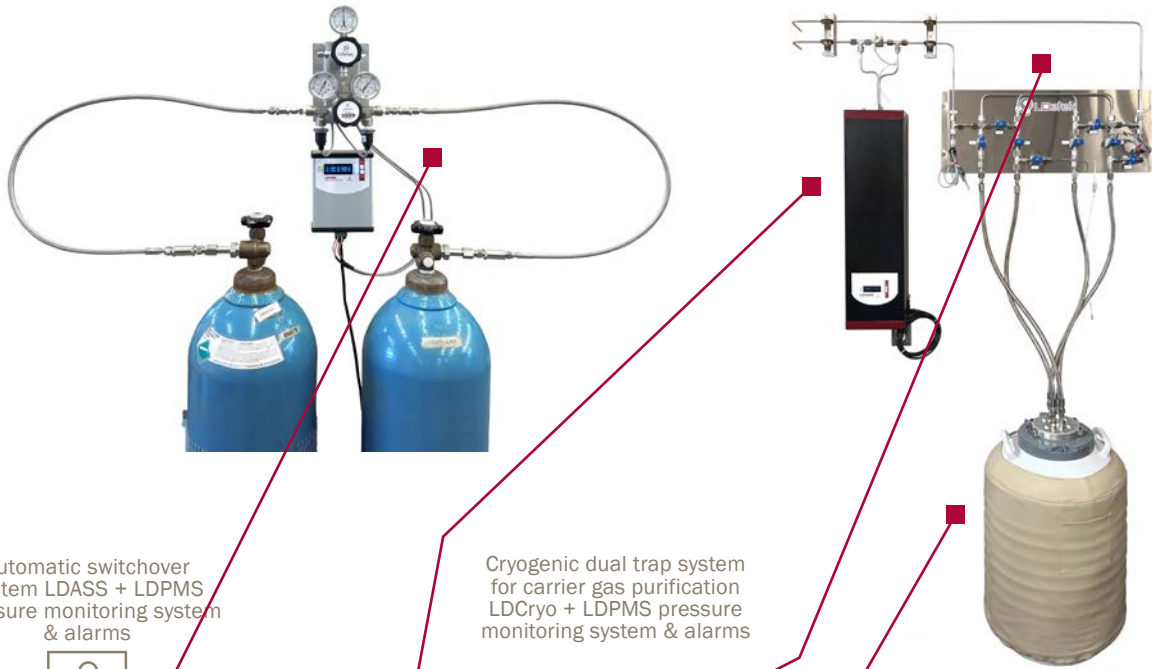

2.0 PRODUCTS

LDGSS



ULTRA HIGH PURITY GAS STREAM SELECTOR



The LDGSS stream selector system brings to the gas industry a reliable and compact solution to provide clean gas to any process GC and online process analyzers. It's compact design, having welded internal flow path manifolds with all stainless-steel piping allows to keep the contamination level to minimum. Combining a choice between the pneumatic stainless-steel purged diaphragm valves or the 3 ways electric peek/stainless-steel solenoid valve, the LDGSS can be configured specifically for your application. By having its fast loops sample bypass purge flowmeters & valves mounted on its front panel for each stream, the system offers the standard fast purging system required by the industry to ensure quick purging and excellent response time for the analytical equipment. Both of the valve configurations offer a sample bypass for the unselected stream that allow each stream to be purged permanently. All unselected streams can be then always ready for analysis without having extra delay required for purging it. The selection valves used are designed to avoid any kind of outboard or inboard leakage offering ultra high purity performances. Depending of the gas stream composition and the application, different type of material or coating can be used to be sure to offers the best compatibility with materials and to keep the best response time possible for the analytical instruments. The LDGSS can be configured for a range of 2-10 streams inside the same compact 3U rackmount enclosure. Each stream inlet has its particle filter frit type to avoid any type of particles to damage the internal valves and flow path. Different options are available and well describes in the specifications.

FEATURES:

- Compact 3U rackmount design reducing project costs.
- Remote & local stream selection
- Leak proof, tested and certified to sub ppb
- Air diffusion resistant design (no inboard/outboard leakage)
- Choice of pneumatic diaphragm valve or electric solenoid valve
- All made of stainless-steel
- No stream cross contamination
- Quick purging time based on the fast loop manifold and the bypass valve configuration
- Internal purge channel in the diaphragm valve design
- Easy to operate
- Can be easily integrated to any type of process G.C. or inline process analyzers
- No maintenance required before 5 years considering 24/7

APPLICATIONS & END USER'S:

- Industrial gases
- Air separation industries
- Semiconductor
- Petrochemical
- Environment
- Energy
- Food and beverage
- Laboratory GC's installation
- System's Integrators
- Glove box

SPECIFICATIONS:

NUMBER OF INLETS	2 to 10 streams configurable
STANDARD FEATURES	<p>Front mounted stream fast loop bypass valves & flowmeters</p> <p>Dry contacts that remotely give status of selected stream</p> <p>Local or Remote control via 12VDC or 24VDC supply</p> <p>Front mounted rotary switch selector for local control</p> <p>Electrical or pneumatic valves available</p> <p>Particle filter frit type 10 microns is mounted on each stream inlet</p> <p>Choice between purged pneumatic valve or 3 ways electric sample bypass valve</p>
OPTIONS	<p>BRP : Sample outlet back pressure regulator to maintain a constant ultra high purity sample outlet pressure control</p> <p>VPB : Valve purged box for toxic and/or hazardous gases</p> <p>PG : Purging gas inlet flowmeter/valve mounted on front panel to adjust the diaphragm valve purge flowrate</p> <p>PR : Stream inlet inline pressure regulator for reducing and adjusting the stream pressure below the maximum operating pressure</p> <p>C : Coating for aggressive or absorbent gases</p> <p>MBP : Metal bellow pump when sample pressure is below 2-3 psig</p> <p>O2 : Oxygen clean certified</p> <p>DBB : Double block and bleed configuration</p>
SAMPLE BYPASS FRONT MOUNTED VALVES/FLOWMETERS FLOW RANGE (FAST LOOPS):	0 to 500 ml/min in reference to air installed by default (larger ranges possible for faster purge)
GAS INLET & OUTLET CONNECTIONS	<p>1/16" - 1/8" - 1/4" Stainless Steel Compression type Swagelok compatible.</p> <p>1/8" - 1/4" Stainless Steel High Purity face seal (VCR) type</p>
PURGED GAS VENT CONNECTIONS	<p>1/8" - 1/4" Stainless Steel Compression Type Swagelok compatible</p> <p>1/8" - 1/4" Stainless Steel High Purity face seal (VCR) type</p>
SUPPLY	85VAC to 240VAC 50/60Hz
POWER CONSUMPTION	Max 15 watts
MAXIMUM OPERATING PRESSURE	<p>30 PSIG (206Kpa) with 3 ways valve version</p> <p>300 PSIG (2068Kpa) with stainless steel diaphragm valve version¹</p>
MINIMUM OPERATING PRESSURE	3 PSIG (20Kpa) (lowest pressure and vacuum mode applications can be achieved by adding the optional metal bellow pump)
NOMINAL WORKING PRESSURE	20 PSIG (138Kpag)
REMOTE CONTROL VOLTAGE INPUT	12 VDC or 24VDC at 200mA maximum
WEIGHT	Max 25 lbs (11Kg)

¹ Front mounted stream bypass valves are not available above 100PSIG

ORDERING INFORMATION:

LDGSS	-XXX	-X	-X/X	-XXX	-X	-XXX
	Operating Voltage 120: 120 Volts 220: 220 Volts	Number of Inlets 2 to 10 : 2 to 10 streams	Gas Inlets Connections Size 1/16 : 1/16 inches 1/8 : 1/8 inches 1/4 : 1/4 inches	Gas Inlets Type VCR : face seal type SWG : compression type	Valve model P : Pneumatic E : Electrical	Options BPR C VPB MBP PG O2 PR DBB

DIMENSIONS:

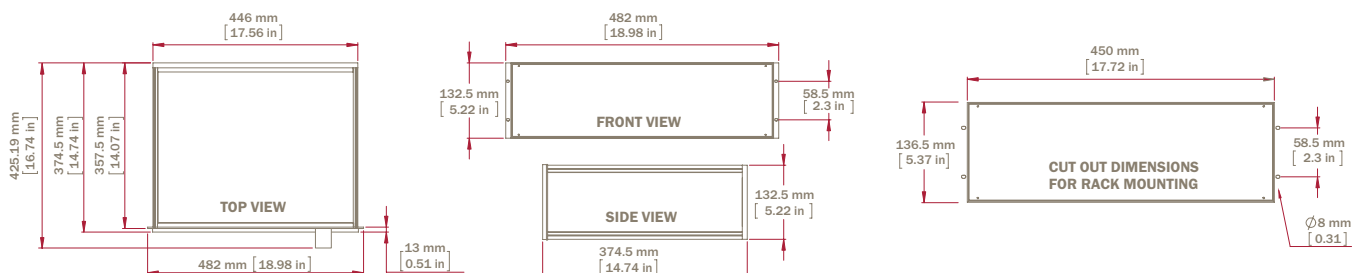

Where innovation leads to success

www.ldetek.com

LDGM

GAS MANIFOLD PANEL FOR ZERO/SPAN/SAMPLE GAS SWITCHING



The LDGM gas manifold is used as an ultra high purity sampling system for any sensor or analytical device that requires switching between a zero gas, a span gas and the sample gas for calibration and proper analysis. The electropolished Stainless Steel 316L gas lines with the quarter turn on/off diaphragm valves guaranteed a quick analysis time without drifting at low ppm/ppb especially for trace analysis Nitrogen, Oxygen and Moisture.

Sample pressure is reduced to the proper operating pressure required by the analytical instrument by adding a Stainless-Steel pressure regulator to the panel.

A valve arrangement containing an inlet/outlet/bypass valves is mounted on the panel when a purifier system is used to generate an ultra pure zero gas source.

TYPICAL INSTALLATION WITH A GAS SENSOR OR A GAS ANALYSER

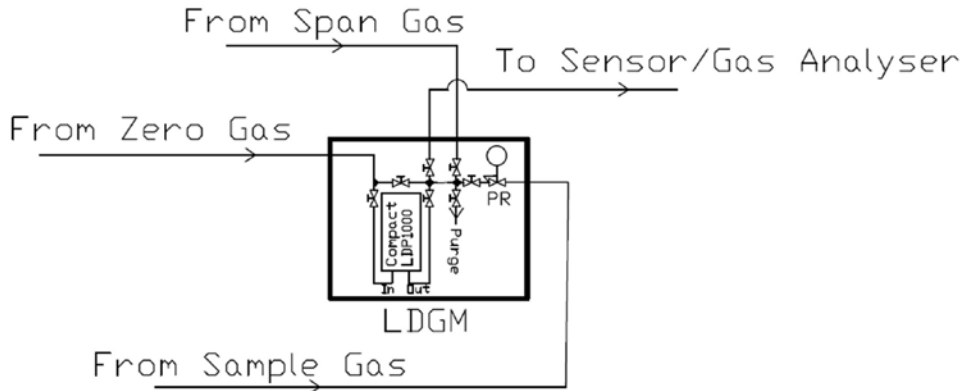

DIMENSIONS

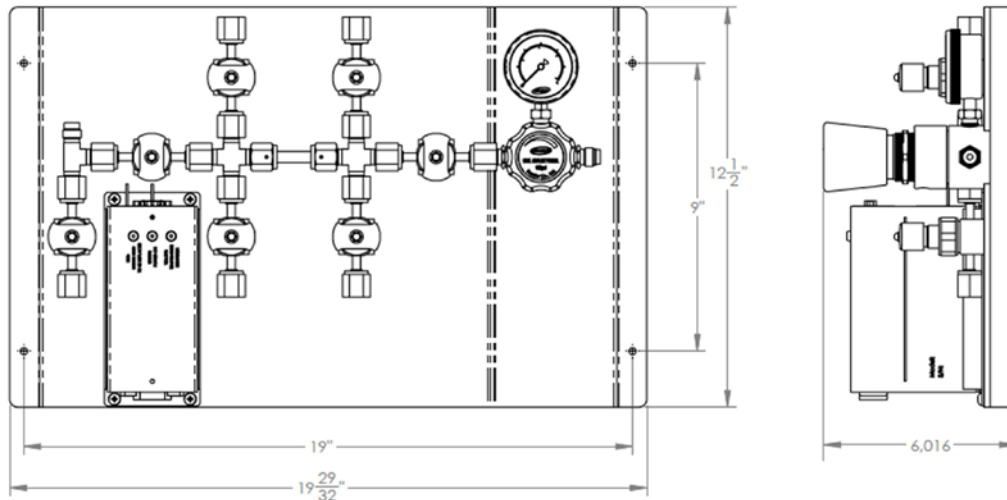

ORDERING INFORMATION

LDGM	-XXX	-XX	-XXX	-XX
	Z : Zero ZS : Zero + Span ZSS : Zero + Span + Sample	2S : 1/8" Compression 4S : 1/4" Compression 2FSF : 1/8" face seal female(VCR) 4FSF : 1/4" face seal female(VCR)	IOB : In/Out/Bypass valves	PR : Pressure regulator

LDGDSA



AUTOMATIC GAS DILUTION SYSTEM



LDGDSA ▲

The LDGDSA is a user's friendly gas dilution system that offers all the flexibility to generate automatically the desired gas mixtures. The Windows user's interface gives the ability to control and monitor the mixtures, flows, pressures and the concentrations remotely. The system can store multiple gas cylinder mixtures and it becomes easy to select the right cylinder to generate different blends. It reduces the cost of having specific standard for each blend needed.

The dilution system is designed with an automatic electronic pressure controller installed on the zero gas line, on the span gas line and to regulate the outlet blended gas line pressure. This way, it improves the stability and the regularity of the flow controls. Each flow table uses a 10 points calibration curve to characterize the linearity of each flow controller.

To ensure ultra high purity zero gas reference to generate ppb blends, an optional integrated heated gas purifier (compact-LDP1000 series) can be mounted on the zero-gas flow path. Our flow path design is also configured with zero dead volume and all made of Stainless Steel 316L hardware to ensure an ultra-high purity for sub ppb blends.

An ultra high purity stainless steel pneumatic shut off valve is mounted on the zero and the span gas lines to cut-off the gas consumption when the unit is in standby mode. These valves can be controlled remotely and are designed to avoid any risk of contamination to be sure to deliver ppt/ppb blends in a quick turn around time. As option, the LDGDSA can be configured with 2 gas inlets for zero and/or for span depending of the requirement in terms of gas blends. In this case, a 2 streams stainless steel selection valve is used to select the proper flow path and gas source for zero and/or for span. For the zero gas, a second gas purifier can be added in the same unit to allow purification of a different gas media to sub ppb.

FEATURES:

- Automatic calculation of dilution concentrations
- Automatic pressure controllers
- Broad range of dilution ratios (up to 1000 to 1)
- Windows user's interface through serial communication
- Multiple gas standard libraries available
- Alarms management
- 3U cabinet
- Integrated heated gas purifier to generate ultra high purity zero gas reference (optional)
- 2 inlets for zero and/or span with UHP Stainless steel selection valve(s) (optional)

APPLICATIONS:

- Multi-point calibration of gas analyzers
- Gas mixture
- Calibration standard of ppb/ppt concentrations for the electronic gas grade instrument. (The integrated heated gas purifier is required)

SPECIFICATIONS:

PRESSURE CONTROLLERS	Electronic pressure regulators	
DILUTION RATIOS	0 – 10 0 – 100	0 – 1000 other ratios possible on request
REPEATABILITY	< 1%	
ACCURACY	Better than ±1%	
OPTIONS	Integrated heated gas purifier for Zero gas reference 2 inlets for zero and/or span with UHP Stainless steel selection valve(s)	
GAS CONNECTIONS	Inlets/Outlets: 1/8" compression fittings (Swagelok type) 1/4" compression fittings (Swagelok type)	1/8" VCR fittings (Swagelok type) 1/4" VCR fittings (Swagelok type) Vents: 1/8" compression fitting (Swagelok type)
Recommended maximum operating pressure:	100 PSIG (6.89 Bar)	
Recommended minimum operating pressure:	10 PSIG (0.7 Bar)	
OPERATING TEMPERATURE	10 °C to 50 °C	
SUPPLY	115 VAC, 50 – 60 Hz or 220 VAC, 50 – 60 Hz	
POWER CONSUMPTION	Maximum 10 watts Maximum 60 watts with optional integrated heated gas purifier	
DRIFT	< ± 1% over 24 hours	
WEIGHT	16 lbs (13 kg)	

ORDERING INFORMATION:

LDGDSA	-X	-X	-X	-XXXX	-XXX	-XX	-XX
	Zero Gas type: A: Argon H: Helium N2: Nitrogen (other possible on request)	Span Gas type: A: Argon H: Helium N2: Nitrogen (other possible on request)	Ratio: 10: 10 to 1 100: 100 to 1 1000: 1000 to 1 (other possible on request)	Inlet/Outlets Fittings 2SWG: 1/8" Swagelok 4SWG: 1/4" Swagelok 2VCR: 1/8" VCR 4VCR: 1/4" VCR	Operating Voltage: 120: 120 volts 220: 220 volts	C: Integrated heated purifier for zero reference CC: Dual integrated heated purifiers for dual zero references	DZ: Dual zero gas inlets with 2 streams isolation valve DS: Dual span gas inlets with 2 streams isolation valve

DIMENSIONS:

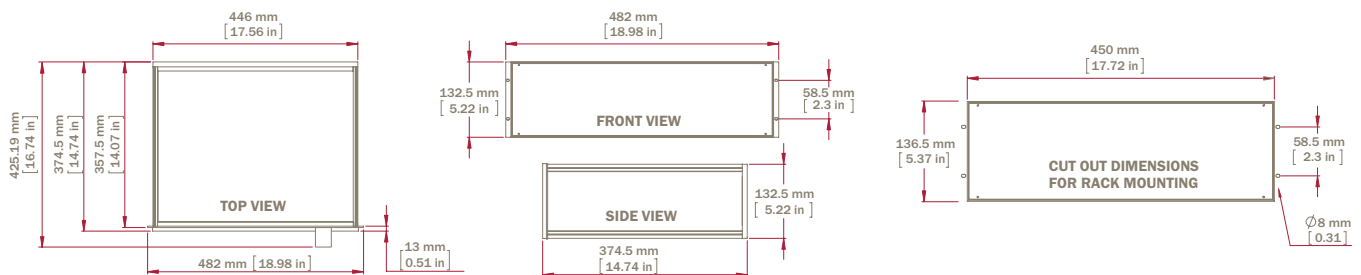

LDPMS



PRESSURE MONITORING SYSTEM



The LDPMS is a stand-alone pressure monitoring system design to monitor the pressure of a gas source. It can monitor up to 2 gas sources simultaneously and generate an independent low-pressure alarm when the pressure level of a source is below its setpoint. If the pressure level for both sources is below the setpoint, a second alarm is generated, and a buzzer is activated. The pressure sensors use are heavy duty series operating from a low-pressure range of 0-50psig(0-6bar) up to 0-8000psig(0-550bar).

APPLICATIONS:

- Industrial / medical / laboratory
- Gas chromatography
- Gas cylinders
- Gas analysers
- Gas detectors
- Compressors
- Hydraulics
- Oil and gas

SPECIFICATIONS

HIGH PRESSURE RANGE MODEL (DEFAULT)	0-3000 psig (0-350 bar) other ranges available on request from scale 0-1000 psig (0-160 bar) to 0-8000 psig (0-550 bar)	
LOW PRESSURE RANGE MODEL (DEFAULT)	0-200 psig (0-25 bar) other ranges available on request from scale 0-50 psig (0-6 bar) to 0-500 psig (0-100 bar)	
PRESSURE SENSOR MATERIAL	Stainless Steel with media-isolated metal diaphragm	
PRESSURE SENSOR GAS CONNECTION (DEFAULT)	¼ NPT other gas connection type available on request	
PRESSURE SENSOR RATED	IP65	
ACCURACY	+/- 0.25% full scale	
OPERATING VOLTAGE	85 ~ 264 VAC	
OPERATING CURRENT	< 0.1A	
OPERATING FREQUENCY	50-60Hz	
RELAY OUTPUTS (4X)	Dry contact N.O & N.C	<ul style="list-style-type: none"> • Relay 1: Status system working • Relay 2: Source 1 low pressure alarm • Relay 3: Source 2 low pressure alarm • Relay 4: Source 1&2 low pressure alarm with buzzer
COMMUNICATION	Serial port RS232 with Modbus RTU (male DB9 connector)	
OPERATING TEMPERATURE	-20 °C to 70 °C (-4 °F to 158 °F)	
OPERATING TEMPERATURE FOR PRESSURE SENSORS	-40 °C to 125 °C (-40 °F to 257 °F)	

DIMENSIONS

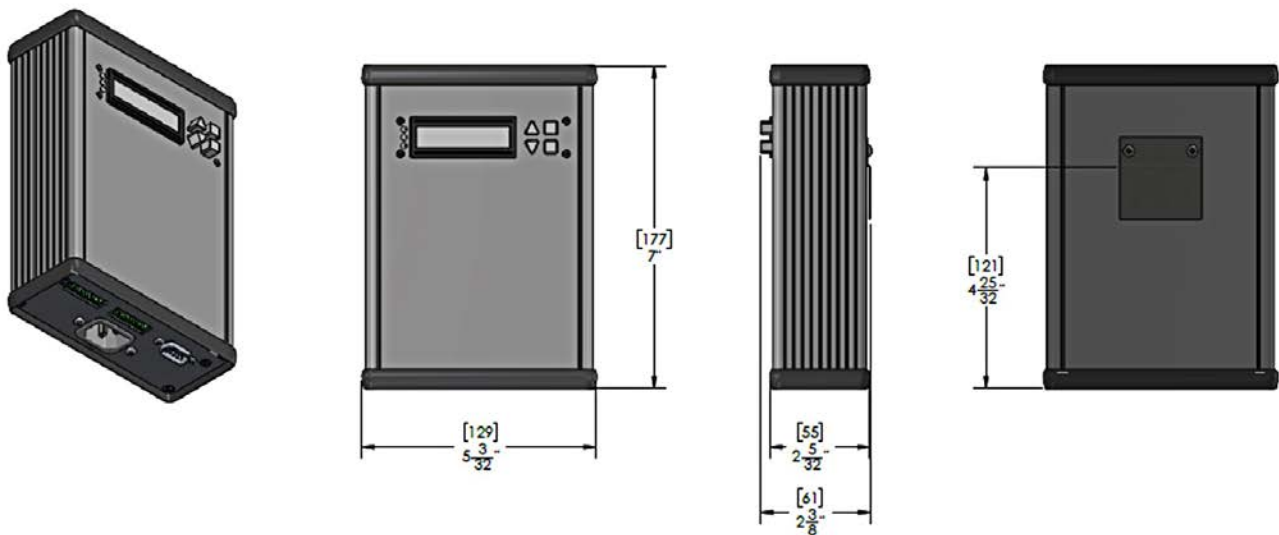

TYPICAL INSTALLATION

Installation on a switchover system to monitor the pressures and then maintain the carrier gas on a gas chromatograph system.



ORDERING INFORMATION

LDPMS	-XX	-XXX
	HP: High pressure (0-3000psig) LP: Low pressure (0-200psig)	NP4: NPT 1/4 NP8: NPT 1/8 NP2: NPT 1/2

LDASS



AUTOMATIC SWITCHOVER SYSTEM



High performance analytical instruments require high purity gas supplies. Our ultra high purity switchover system and valves series are especially designed for trace impurities analytical devices.

The LDASS (automatic switchover system) series is specially designed to provide continuous gas flow from two high pressure sources. They are complete high purity changeover system which combines the changeover regulator and a line regulator into a compact wall mount system for ultra high purity and specialty gases.

Diffusion-resistant metal diaphragm seal ensures gas purity and integrity. Mounting bracket is standard and internal parts are stainless steel 316L and suitable for cylinder gas, bulk gas line, mixed gas or any other type of gaseous mixtures.

TYPICAL INSTALLATION

Automatic switchover system with its pressure monitoring system.



SPECIFICATIONS

PORTS	¼ FNPT
LEAK RATE CERTIFICATION	2 x 10 ⁻⁸ atm cc/sec Helium
BODY MATERIAL	Stainless Steel 316L
DIAPHRAGM	Stainless Steel 316L
MAIN VALVE	Stainless Steel 316L
VALVE SPRING	Stainless Steel 316L
VALVE SEAT	Teflon
MAX INLET PRESSURE	3500psig (238bar)
MAX OUTLET PRESSURE	145psig (10bar)
OPERATING TEMPERATURE	-40 °C to +70 °C (-40 °F +158 °F)
FLOW CAPACITY	Cv 0.06
FLEXIBLE HOSES	Come with 2 x one-meter Braided Stainless Steel with CGA580 ends with lok-filters and check valves*
OPTIONAL	Pressure monitoring system (LDPMS) **

*The end lok-filters avoid the flexible hose the get contaminated with particles and air when changing for a new filled bottle. a safety additional check valve is mounted on the flexible hose to avoid back flow from the full bottle.

**One pressure sensor mounted on each side of the switchover system, then when one bottle get below the accepted pressure limit, an alarm output is activated.

DIMENSIONS

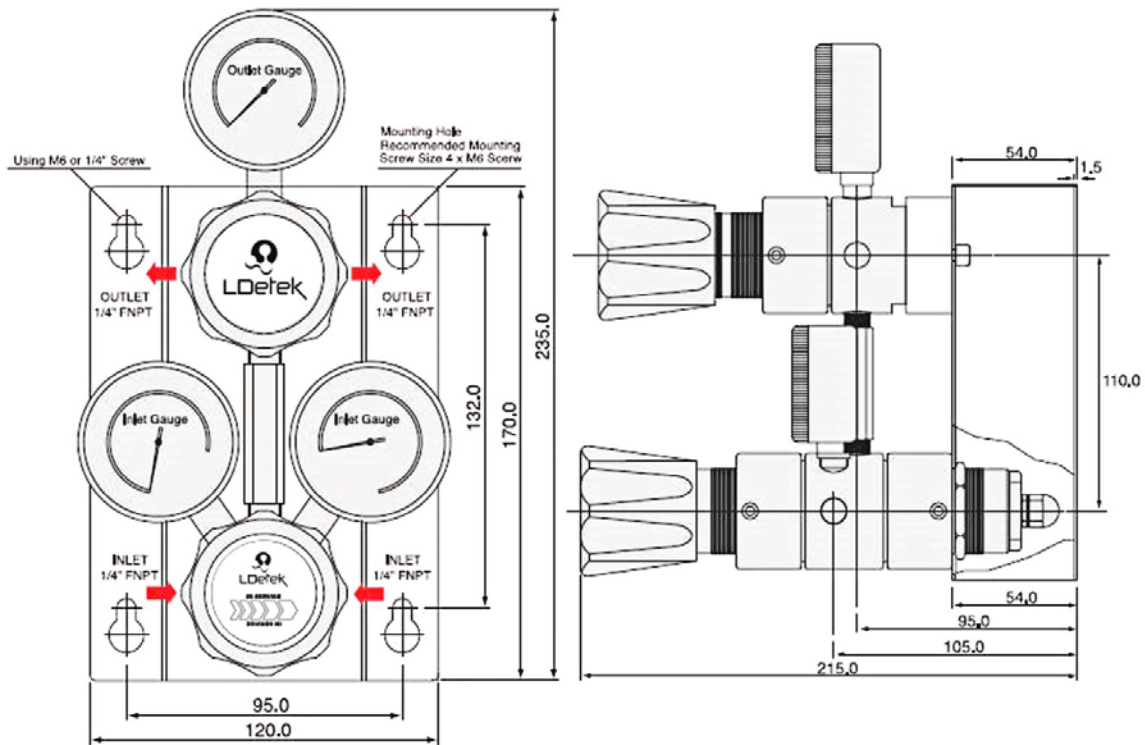

ORDERING INFORMATION

LDASS	S	010	NP4	S	580	1	LDPMS
Series	Body material	Max outlet pressure	In/Out ports size	Flow capacity	CGA type	Hose length	Options
Standard inlet pressure up to 3500 psig (238 bar)	S: Stainless steel 316L	010: 1-10 bar (1-145 psig)	NP4: ¼ FNPT	S: Cv 0.06	580: CGA580 ends mounted on the flexible hoses	1: 1 meter	LDPMS: Low pressure monitoring system with alarm module with 2 pressure sensors/lcd

LINE PRESSURE REGULATORS & SHUT OFF VALVES



LDPRR

PRESSURE REGULATOR SERIES



The LDPRR pressure regulator series is the pressure reducing regulator designed to use at the special manufacturing line of ultrahigh pure semi-conductors, bulk gas lines, and other facility lines. In order to use at the semi-conductor hook-up line, regulator's internal surface is treated to the level of E.P. 10Ra, 5Ra under B. A. grade. A special locking-plate system has developed and applied. All the process assembly, welding, testing and washing of this series is carried out and thoroughly managed in clean room.

Developed push and lock type handle which completely prevents the self-change of pre-set value which can be caused by the vibration from outside or minute vibration at the gas pipeline. You can prevent the self-changing of preset value just by pushing the handle and reset the value freely by drawing the handle.

FUNCTIONAL SCHEMATIC

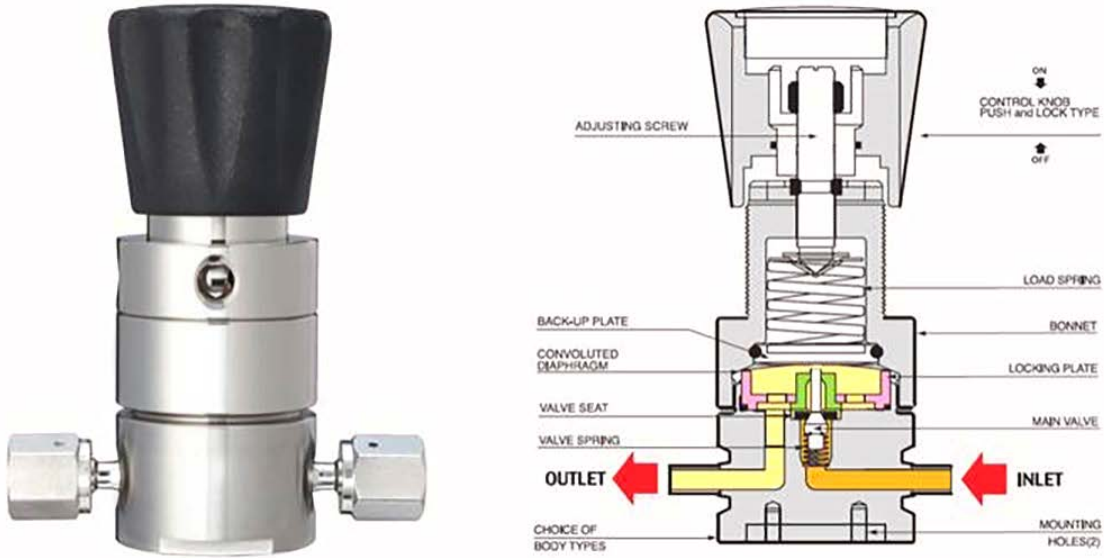

DIMENSIONS

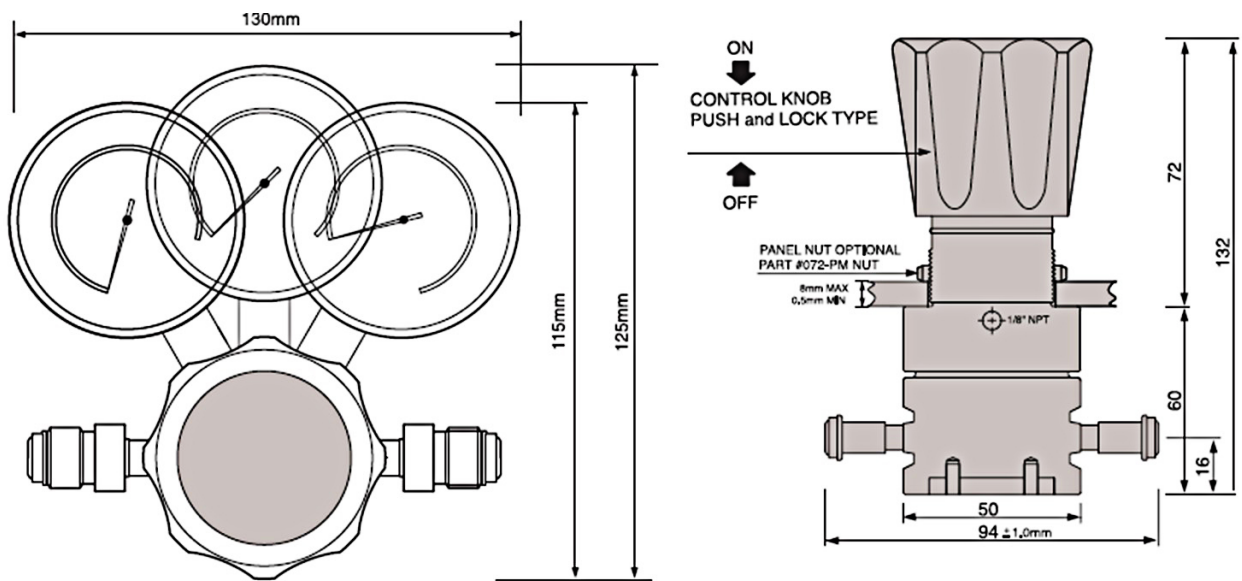

SPECIFICATIONS

VCR TYPE REGULATOR

DESIGNED FOR SEMICONDUCTOR APPLICATIONS

INTERNAL SURFACES B. A. GRADE TO E. P. 10 RA, 5 RA

ALL PERFORMED IN CLASS 100 AND CLASS 10 CLEAN-ROOMS

THREADLESS TYPE

LOCKING-PLATE SEAL SYSTEM

ORDERING INFORMATION

LDPRR	B	100	S	H	P	S	4MS	G1S
Series	Body material	Max outlet pressure	Diaphragm material	Max inlet pressure	Seat material	Flow capacity	Inlet/Outlet ports size	Gauge
Pressure reducing regulator for Ultra high purity series rated for semiconductor	B: Electropolish Stainless steel 316L 10Ra	100: 0.1-7 bar (1-100 psig)	S: Stainless Steel 316L	H: 3500 psig (238 bar)	P: PCTFE	S: Cv 0.06 standard 0-3000 psig, ¼"	4MS: ¼ Male VCR inlet/outlet	G1S: Gauge ¼" installed

LDMSV

ULTRA HIGH PURITY MANUAL SHUT OFF VALVE



The LDMSV manual diaphragm shutoff valve series is specially designed for ultra high purity applications where sub ppb detection and trace analysis are required. This manual shut off valve can be mounted upfront the analytical devices/sensors or used for isolation/bypass lines mounted with purifiers/traps. They are also perfect to be mounted on the pressure regulators outlets and the sampling systems. Having a ¼ turn handle which interact on a diaphragm sealing makes it ideal for quick and precise shutoff without dead volume or leakage. The body is made of Stainless Steel 316L welded, and connections are face seal ¼ type to ensure the purity level.

SPECIFICATIONS

PRESSURE RATING	Vacuum to 290 psig (20 bar)
TEMPERATURE RATING	-9.4°F ~ 149°F (-23°C ~ 65°C)
FLOW COEFFICIENT	0.60
BODY MATERIAL	SS316L
DIAPHRAGM MATERIAL	Ni-Co Alloy
HANDLE MATERIAL	Aluminum (Blue) Handle shape provides visual identification of OPEN and CLOSED positions

DIMENSIONS

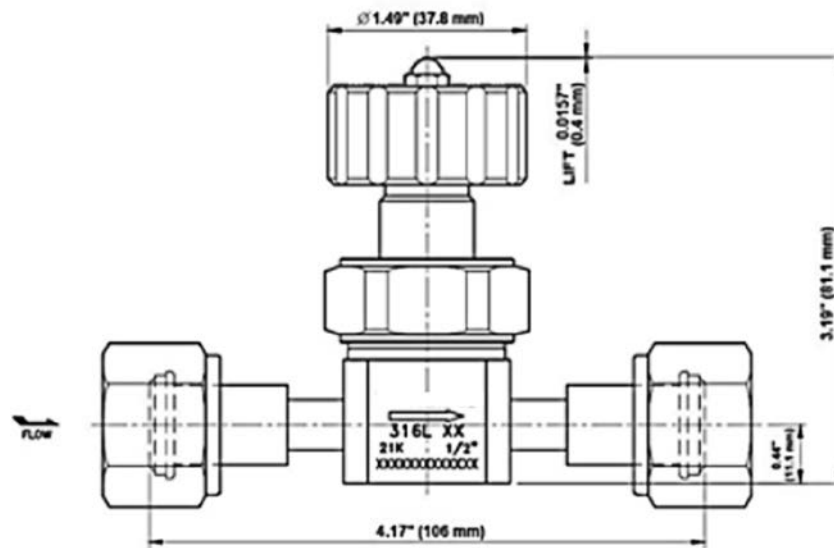

ORDERING INFORMATION

LDMSV	S	4FS
Series	Body material	Inlet/Outlet ports size
¼ turn diaphragm shutoff valve for Ultra high purity rated for semiconductor	S: Electropolish Stainless steel 316L	4FS: ¼ Female VCR inlet/outlet

LDPSV

ULTRA HIGH PURITY PNEUMATIC SHUT OFF VALVE



The pneumatic diaphragm shutoff valve series is specially designed for ultra high purity applications where sub ppb detection and trace analysis are required. This pneumatic shut off valve can be mounted upfront the analytical devices/sensors or used for isolation/bypass lines mounted with purifiers/traps. They are also perfect to be mounted on the pressure regulators outlets and the sampling systems. Having a pneumatic actuation which interact on a diaphragm sealing makes it ideal for quick and precise shutoff without dead volume or leakage for remote applications. Ideal for stream selector systems to be controlled remotely. The body is made of Stainless Steel 316L welded, and connections are face seal ¼ type to ensure the purity level. The valve can be configured with normally open or normally close position.

SPECIFICATIONS

PRESSURE RATING	250 psig (17.2 bar)
TEMPERATURE RATING	-10 to 160 °F (-23 to 65 °C)
FLOW COEFFICIENT	0.27
PORT POSITION	NC or NO
BODY MATERIAL	SS316L for Ultrahigh Purity Applications
FULLY SWEEPED FLOW PATH	Minimizes Entrapment Areas and Maximizes Flow Capacity
FULLY CONTAINED PCTFE SEAT DESIGN PROVIDES:	<ul style="list-style-type: none">• Outstanding Resistance to Swelling and Contamination• Improved Helium Leak Test Performance• Minimal Particle Generation• Long Cycle Life
DIAPHRAGM	<ul style="list-style-type: none">• Excellent in Strength and Corrosion Resistance• Optimal Design for Long Cycle Life

DIMENSIONS

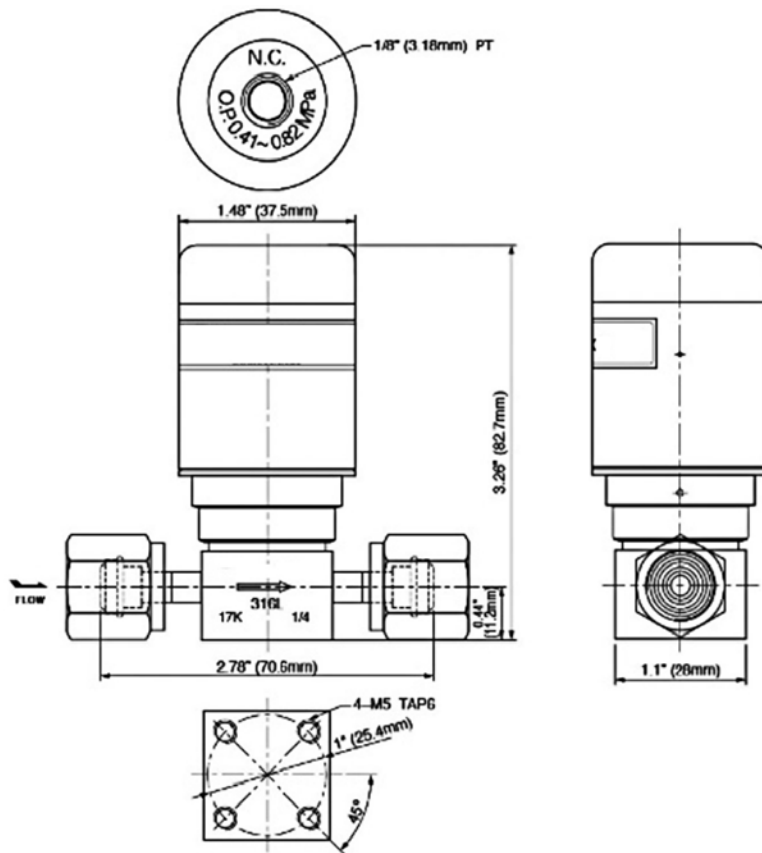

ORDERING INFORMATION

LDPSV	S	4FS	NC/NO
Series	Body material	Inlet/Outlet ports size	Port position
1/4 turn pneumatic diaphragm shutoff valve for Ultra high purity rated for semiconductor	S: Electropolish Stainless steel 316L	4FS: 1/4 Female VCR inlet/outlet	NC: Normally close position NO: Normally open position

COMPRESSION TUBE FITTINGS

As a result of tremendous efforts in research and development during the last years, with a lot of involvement in the gas analysis and gas chromatography industries with our different partners, this dead volume free compression fitting series is the best for the trace analysis industries.

FEATURES

- 316L Stainless Steel
- Clean for UHP gas chromatography applications
- No dead volume design
- Optional surface treatment available

TYPICAL APPLICATIONS

- Gas chromatography
- Gas analyser instruments
- Sampling system
- Flow & pressure

HOW DOES IT WORK?

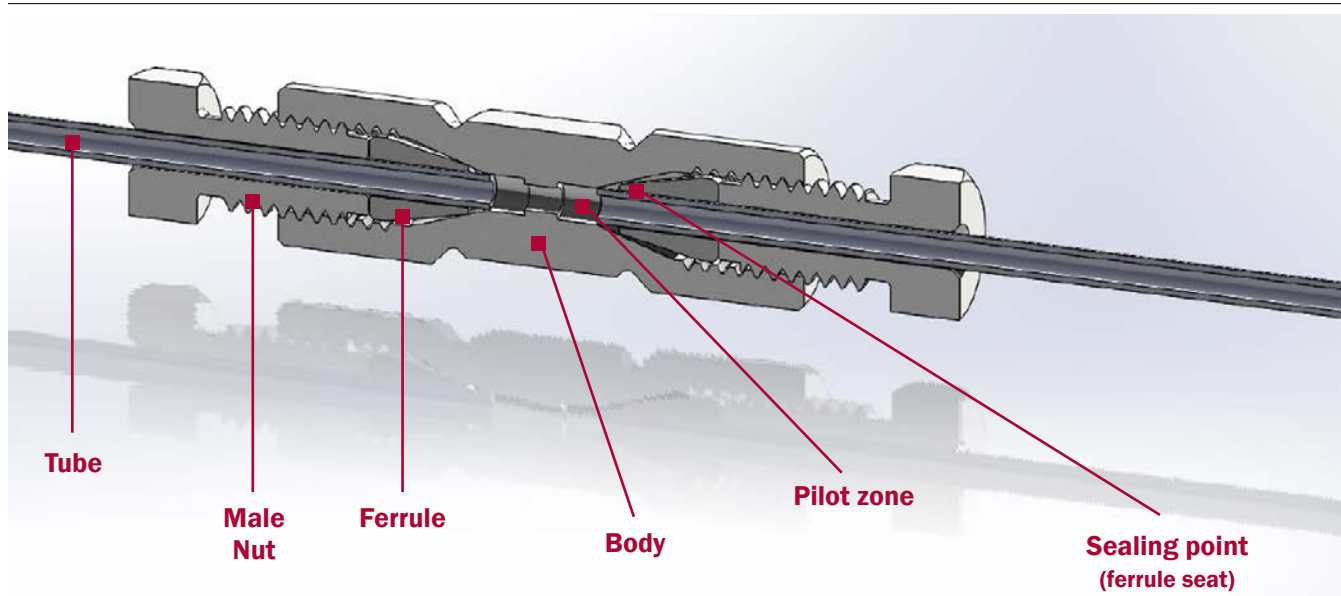

The tube is inserted in a male nut and a ferrule into the body of the fitting until the tube reach the pilot zone. The tube won't fully penetrate the pilot zone as other type of fittings does. This particularity here allows to avoid the risk of tube swelling. Such phenomenon regular happens with other type of compression fittings, resulting in difficulties of extracting the tube once it is tighten. By having its sealing point located at the right point on the tube, it makes a kind of sealing cut on the tube which gives an unsurpassed type of sealing. At the same time than the cut happens to seal on the tube by the inner side of the ferrule, the outer side of the ferrule seals the gap on the body of the fitting. The male nut here push on the ferrule in a linear direction allowing the ferrule to not turn on the tube and then damage its seat.

Combined with a rigorous machining & cleaning quality, this series of fittings are unbeatable when measuring trace impurities is required for the gas analysis industries.

UNIONS & FILTERING UNIONS

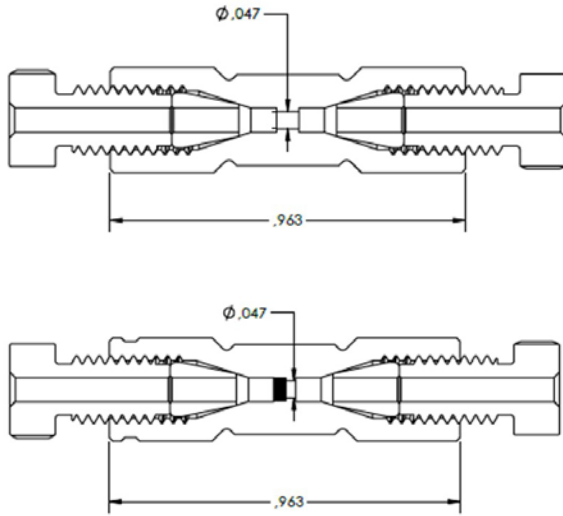

PART NUMBER	TUBE OD SIZE (INCH)	MATERIAL	OPTIONS
LDU-1/16-SS	1/16	Stainless Steel	n/a
LDU-1/16-SS-10u	1/16	Stainless Steel	10 micron press in filter
LDU-1/16-SS-SC	1/16	Stainless Steel	Sulfinert coating

REDUCING UNIONS



PART NUMBER	TUBE OD SIZE (INCH)	TUBE OD SIZE (INCH)	MATERIAL	OPTIONS
LDRU-1/8 to 1/16-SS	1/8	1/16	Stainless Steel	n/a
LDRU-1/8 to 1/16-SS-10U	1/8	1/16	Stainless Steel	10 micron press in filter
LDRU-1/8 to 1/16-SS-SC	1/8	1/16	Stainless Steel	Sulfinert coating

CROSSES

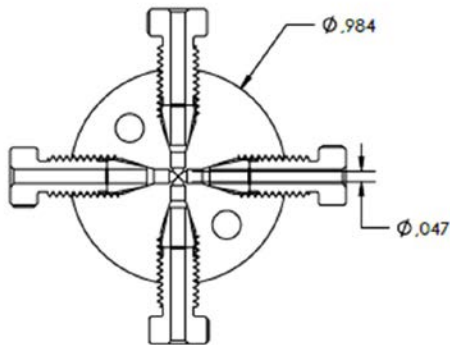

PART NUMBER

TUBE OD SIZE (INCH)

MATERIAL

OPTIONS

LDC-1/16-SS

1/16

Stainless Steel

n/a

LDC-1/16-SS-SC

1/16

Stainless Steel

Sulfinert coating

TEES

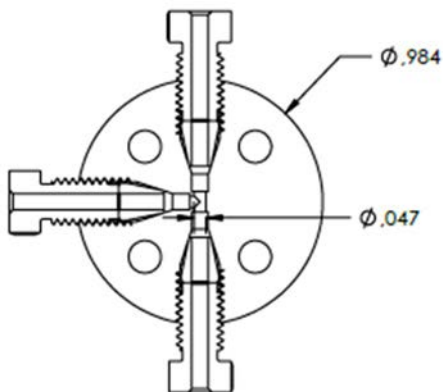

PART NUMBER

TUBE OD SIZE (INCH)

MATERIAL

OPTIONS

LDT-1/16-SS

1/16

Stainless Steel

n/a

LDT-1/16-SS-SC

1/16

Stainless Steel

Sulfinert coating

SHORT NUTS

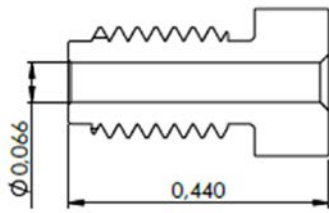

PART NUMBER	TUBE OD SIZE (INCH)	MATERIAL	OPTIONS
LDSN-1/16-SS	1/16	Stainless Steel	n/a
LDSN-1/16-SS-SC	1/16	Stainless Steel	Sulfinert coating
LDSN-1/8-SS	1/8	Stainless Steel	n/a
LDSN-1/8-SS-SC	1/8	Stainless Steel	Sulfinert coating

FERRULES

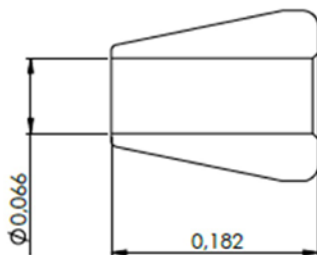

PART NUMBER	TUBE OD SIZE (INCH)	MATERIAL	OPTIONS
LDF-1/16-SS	1/16	Stainless Steel	n/a
LDF-1/16-SS-SC	1/16	Stainless Steel	Sulfinert coating
LDF-1/8-SS	1/8	Stainless Steel	n/a
LDF-1/8-SS-SC	1/8	Stainless Steel	Sulfinert coating

LONG NUTS

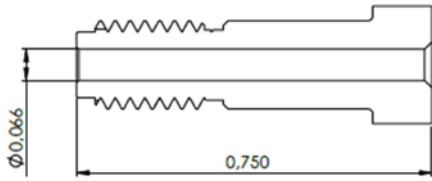

PART NUMBER	TUBE OD SIZE (INCH)	MATERIAL	OPTIONS
LDLN-1/16-SS	1/16	Stainless Steel	n/a
LDLN-1/16-SS-SC	1/16	Stainless Steel	Sulfinert coating

CAPS

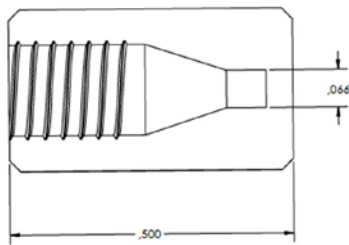

PART NUMBER	TUBE OD SIZE (INCH)	MATERIAL	OPTIONS
LDC-1/16-SS	1/16	Stainless Steel	n/a

PLUGS

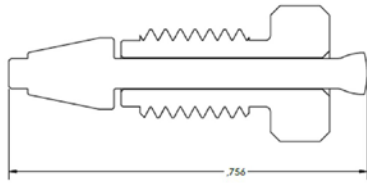

PART NUMBER	TUBE OD SIZE (INCH)	MATERIAL	OPTIONS
LDP-1/16-SS	1/16	Stainless Steel	n/a
LDP-1/16-SS-SC	1/16	Stainless Steel	Sulfinert coating

ADAPTER 10-32

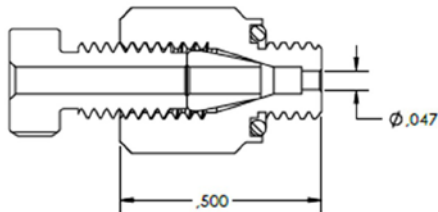

PART NUMBER	TUBE OD SIZE (INCH)	MATERIAL	OPTIONS
LDA1032-1/16-SS	1/16	Stainless Steel	n/a
LDA1032-1/16-SS-SC	1/16	Stainless Steel	Sulfinert coating

ADAPTER NPT

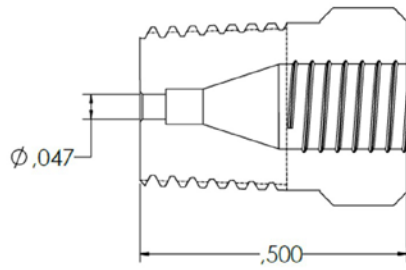

PART NUMBER	NPT SIZE (INCH)	TUBE OD SIZE (INCH)	MATERIAL	OPTIONS
LDANPT-1/8-1/16-SS	1/8	1/16	Stainless Steel	n/a
LDANPT-1/8-1/16-SS-SC	1/8	1/16	Stainless Steel	Sulfinert coating



3.0 APPLICATION NOTE

3.1 ENVIRONMENT



3.0 APPLICATION NOTES

APPLICATION NOTE

LD12-01



Greenhouse analysis with the PlasmaDetek

The popularity to measure greenhouse gases (CH₄, CO₂ and N₂O) has increased considerably in the last years with the global warming concerns. Chromatography is the well known technique to measure them and different detectors are used to achieve this task. This application note will explain how we can effectively do it with a simple gas chromatograph configuration involving the PlasmaDetek detector.

PLASMADETEK CONFIGURATION:

The PlasmaDetek has the advantage that it can be configured to be more sensitive on some compounds than the others. This selectivity configuration helps the chromatography to be more effective and easier to setup.

For this application, the detector system is configured to be selective on all three impurities with two dedicated outputs signal:

- Output 1 : N₂O
- Output 2 : CH₄ and CO₂



▲ PlasmaDetek detector

CHROMATOGRAPHY CONFIGURATION:

Typical configuration to make such measurement requires methanizer, FID and ECD detectors, H₂ Fuel, make up gas and air supply.

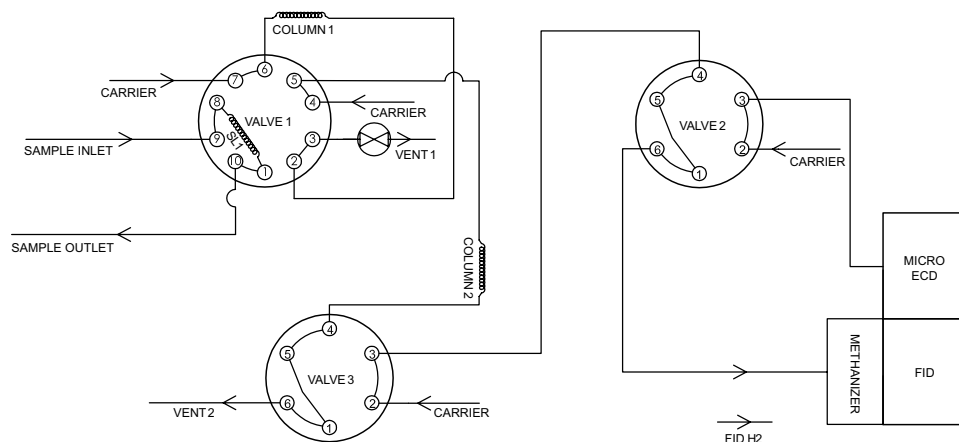

Figure 1: Typical configuration for greenhouse measurement

With the PlasmaDetek, only one detector can be used to measure CH₄, CO₂ and N₂O in air. All three components elute in the same detector. That reduces cost and complexity of the system.

Another advantage is the use of argon or helium as carrier gas. Both carriers are suitable and give the performance desired.

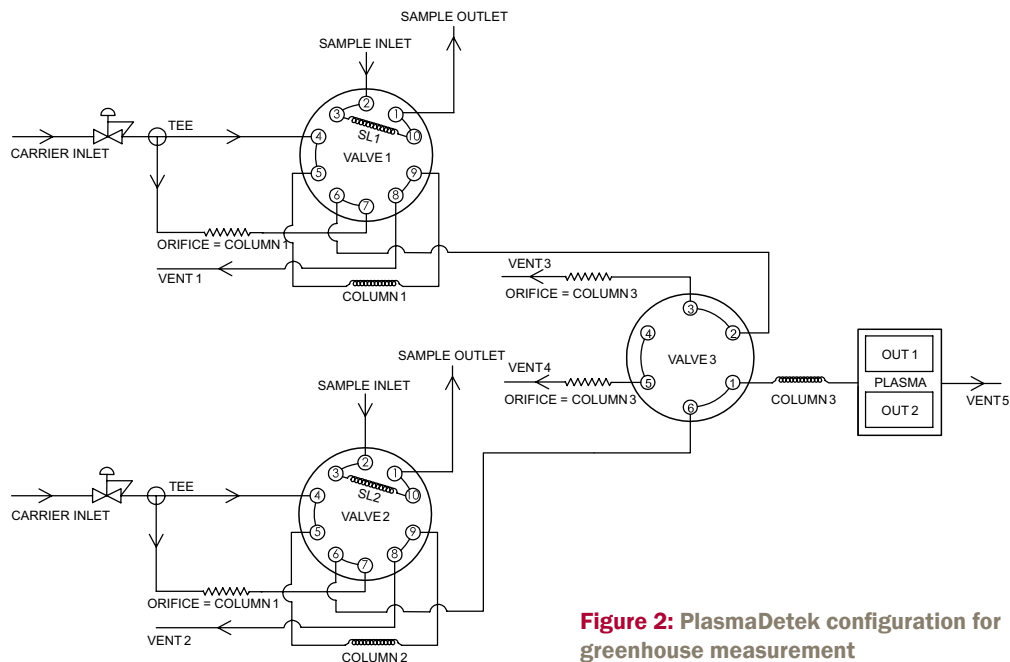

Figure 2: PlasmaDetek configuration for greenhouse measurement

Valve 1 is used for CH₄ and CO₂ measurement. The backflush to vent configuration vents out water from the sample with a HayeSep D 100/120 10'(column 1). Valve 3 is used to vent out air before going to the other HayeSep D 100/120 10'(column 3). This second column separates CH₄ and CO₂ from the remaining air.

Valve 2 is also configured in a backflush to vent with a HayeSep D 100/120 10'(column 2). A different sampling loop size is used to be able to measure N₂O. Valve 3 is used to vent out air and CO₂. N₂O is then brought to the detector by itself and can be measured in very low concentration.

RESULTS AND PERFORMANCE:

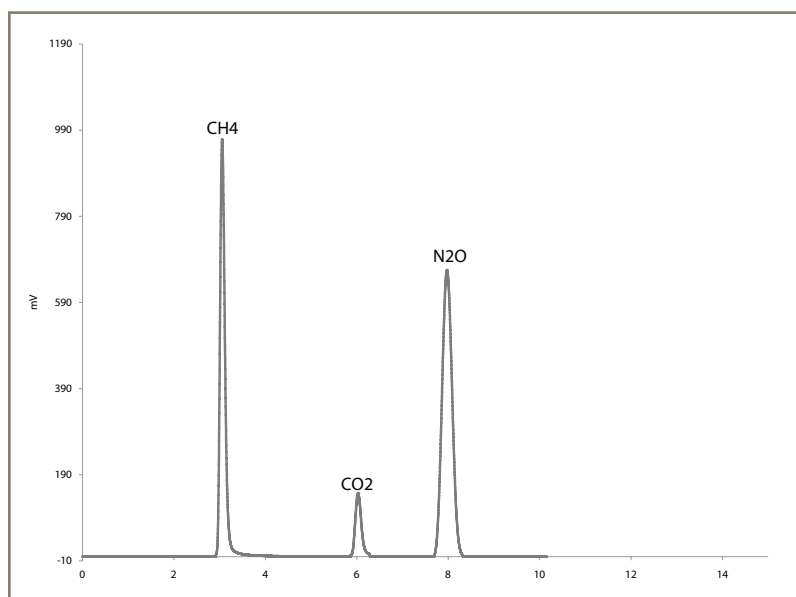

Figure 3: 8 ppm CH₄, 50 ppm CO₂ and 10 ppm N₂O in helium

Figure 3 shows the chromatogram obtained with the LDetek configuration described above, with a 8 ppm CH₄, 50 ppm CO₂ and 10 ppm N₂O standard. This result was used to calculate the LOQ and LOD of each compounds shown in figure 4.

COMPONENT	CONCENTRATION	PEAK HEIGHT	NOISE	S/N	LOD (ppb) S/N = 3	LOQ (ppb) S/N = 5
CH ₄	8 ppm	965 mV	0.04 mV	24125	1	1.65
CO ₂	50 ppm	143 mV	0.04 mV	3575	42	70
N ₂ O	10 ppm	671 mV	0.04 mV	16775	1.8	3

Figure 4: LOQ and LOD calculation

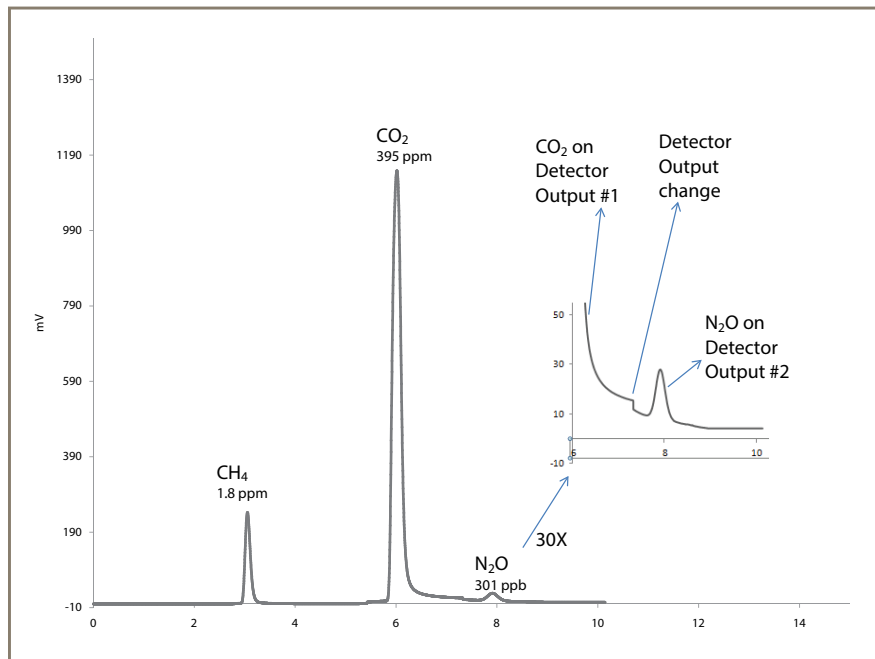

Figure 5: CH₄, CO₂ and N₂O in ambient air

All three components are measured without interference in air providing accurate and very sensitive detection. The LOD of N₂O ensures that its measurement in air is detected easily.

Those results and performances depend on the chromatographic system and conditions of operation.

CONCLUSION:

This technique is simple and cost effective compared to the most common configurations that can be found on the market. No make-up gas, fuel, air, FID and ECD radioactive detector are required to make this measurement. Only one PlasmaDetek detector with two outputs using argon or helium as carrier gas can be used to achieve level of sensitivity needed. The ease of installation and startup of the PlasmaDetek makes it perfectly suitable for this environmental application.

APPLICATION NOTE

LD15-03



Measurement of part per billion N₂O in air



MultiDetek2 ▲

With the global warming concerns, it is more and more critical to measure the nitrous oxide (N₂O) concentration in the ambient air. This application note will demonstrate how efficient the use of the PlasmaDetek-E is for the measurement of extremely low concentration of N₂O in ambient air without interference.

LDETEK SOLUTION:

It is well known that the measurement of N₂O can be achieved with different kinds of detectors using specific chromatography techniques. The ECD, HID and conventional PED are the mostly used type of detectors for this greenhouse application. The radioactive source coming from the ECD makes this detector less attractive due to the latest worldwide regulations about radioactivity, even for low source of radioactivity. The HID and conventional PED are relatively good detectors for such analysis, but create more chromatography challenges caused by lack of selectivity and sensitivity. With the LDetek PlasmaDetek-E, the enhanced sensitivity and selectivity make it the ideal tool for measuring extremely low concentration N₂O in ambient air with reduced interference mostly coming from the high concentration carbon dioxide and moisture.

The improved operation's mode and the optical design of the PlasmaDetek-E combined with right chromatography configuration in the MultiDetek-2 compact GC remove the interference usually coming from the carbon dioxide and moisture.

The MultiDetek-2 system is configured with one injection diaphragm valve V1, which is used for injecting the sampling volume into the chromatography system. A first packed Shincarbon column is combined with a heartcut diaphragm valve V2 and a second packed Shincarbon column to catch the desired N₂O peak and flush to vent the undesired interference gases. The N₂O peak is then going to the PlasmaDetek-E where proper analysis is performed.

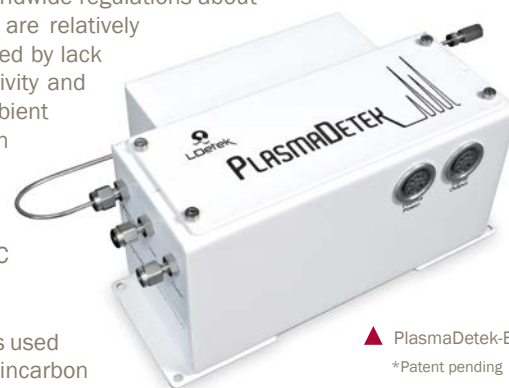

▲ PlasmaDetek-E
*Patent pending

This combination makes it ideal to measure extremely low concentration N₂O in air without having the N₂O peak integrated in the high concentration CO₂ tailing. This technique has been tested up to 5000ppm CO₂ for measuring as low as 1ppb N₂O as demonstrated in the chromatograms.

The MultiDetek-2 can be configured with different sampling mode to get the sample gas ready for analysis. The drawing of this application note shows the use of a micro pump that is mounted just before the sampling loop. The pump is fully controlled from the software interface and can be switched On/Off adequately for a specific period of time to allow proper sample gas quantity going to the sampling loop mounted on the diaphragm valve V1. This way, the loop is filled just before running an analysis. This technique allows to minimize the sample gas volume required for analysis since in many cases, the sample gas comes from bags, balloons, canisters or others. It is then critical to minimize the sample gas volume for every analysis.

An optional sample line purge system can also be added to the sampling mode of the MultiDetek-2. This system uses the carrier gas to purge the sample line prior to pump the sample gas from its source. This way, the sample flow path and sampling loop are totally purged with N₂O free gas since the carrier gas used as purge gas comes from the heated LDetek, model LDP1000 getter that removes N₂O down to 0.01ppb level.

The MultiDetek-2 can also have an injector system with septum for syringe injection mode. The system is directly mounted on the injection diaphragm valve V1.

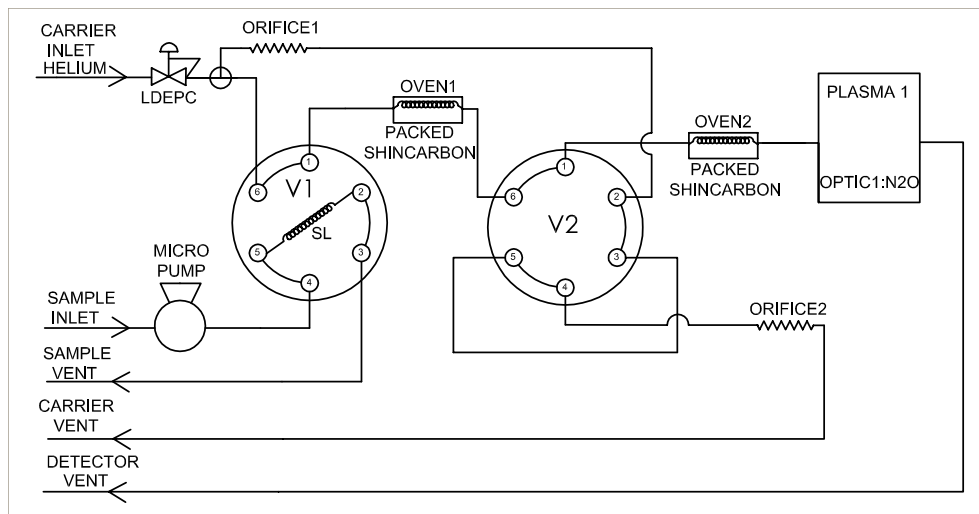

MultiDetek-2 configuration diagram 1: V1 position OFF: Filling sampling loop
V2 position OFF: Catches N₂ peak from the first packed Shincarbon in oven #1 to the second packed Shincarbon in oven #2

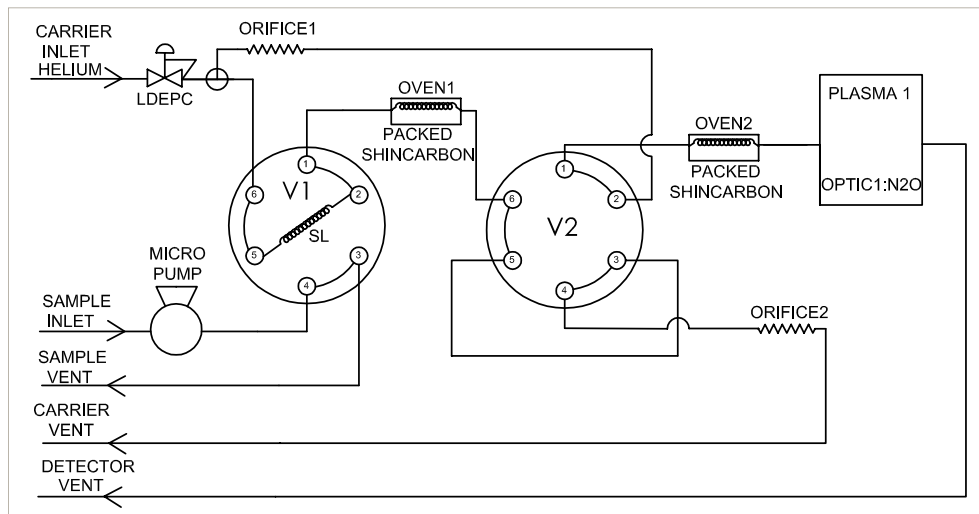

MultiDetek-2 configuration diagram 2: V1 position ON: Injecting sampling loop
V2 position ON: Flushes to vent the interference gases (air, carbon dioxide, moisture and others) coming out from the first packed Shincarbon in oven #1

RESULTS:

Low ppb Chromatogram examples

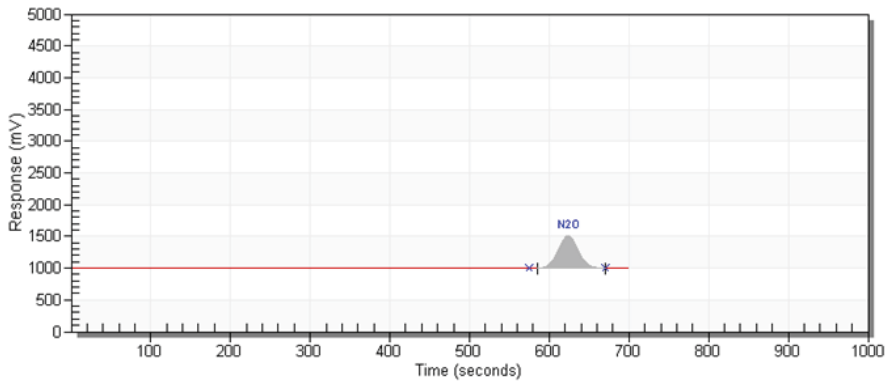

Chromatogram 1:
140ppb N₂O in air

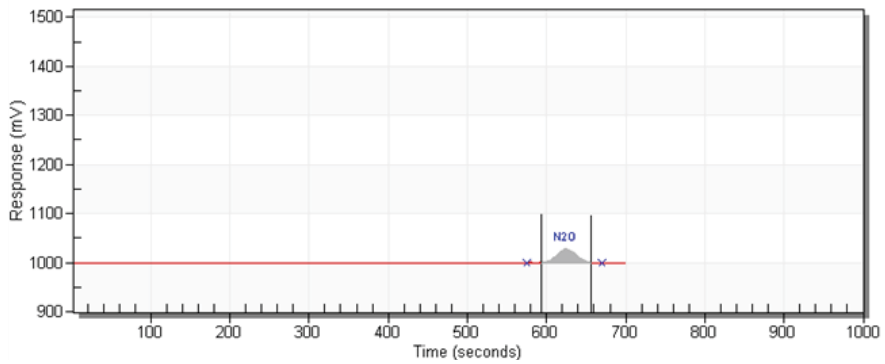

Chromatogram 2:
7ppb N₂O in air

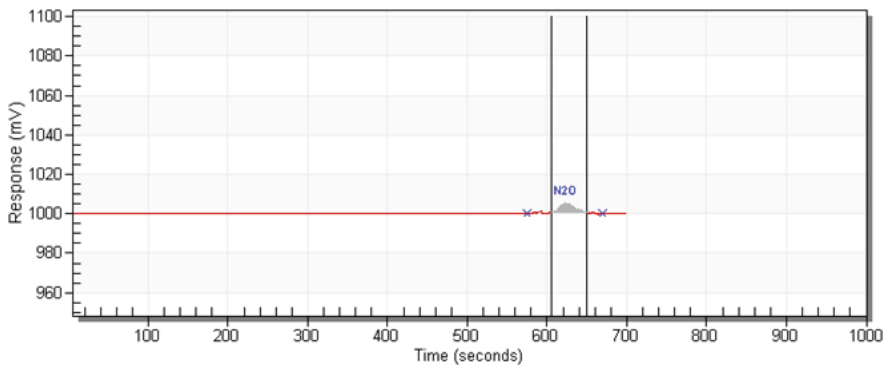

Chromatogram 3:
1ppb N₂O in air

LDL calculation:

COMPONENT	CONCENTRATION	PEAK HEIGHT	NOISE	LDL (3X NOISE)
N ₂ O	1ppb	6 mV	0.2 mV	0.1 ppb

Note: other LDL could be obtained with different injection volume and chromatographic conditions

CONCLUSION:

With its user-friendly interface and the simple configuration of this compact GC, the MultiDetek-2 is a perfect fit for this greenhouse application. The enhanced sensitivity and selectivity of the PlasmaDetek-E allow extreme low limits of detection. This new measurement technique combined with the integrated purged low volume sampling gas system brings this technology over the existing conventional measurement methods and systems.

APPLICATION NOTE

LD16-01



Air analysis using the MultiDetek2 and PlasmaDetek2



▲ MultiDetek2

▲ PlasmaDetek2

LDETEK SOLUTION:

The air analysis for environmental applications is more and more required in different regions of the world. In this application note, the trace analysis of acids, sulfurs and nitrous oxide has been combined in one single compact instrument using one detection technology based on plasma emission (PlasmaDetek2). The MultiDetek2 compact GC has been configured with parallel channels to achieve the measurement at low ppb level for the different impurities. The sample collection can be performed with micro pump for ambient pressure application or bags, with a proportional micro valve for positive pressure application to control flow rate or with our auto injector headspace for vials. The MultiDetek2 was built using heated zones to avoid cold points between the columns and the plasma detector. The detector, valves, fittings and tubing are made of coated stainless steel to avoid surface adsorption. This ensures good sensitivity and repeatability measuring impurities.

RESULTS:

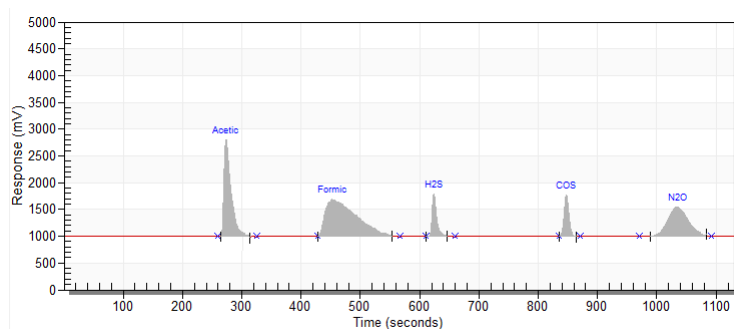

Figure 1 :
Chromatogram of trace impurities in balance air

COMPONENT	CONCENTRATION	PEAK HEIGHT	NOISE	LDL (3X NOISE)
Acetic acid	0.27 ppm	2850 mV	36 mV	0.010 ppm
Formic acid	0.20 ppm	1785 mV	46 mV	0.015 ppm
H2S	3.00 ppm	1860 mV	1.6 mV	0.008 ppm
COS	3.00 ppm	1870 mV	1.9 mV	0.009 ppm
N2O	2.30 ppm	1595 mV	0.4 mV	0.001 ppm

Note: other LDL could be obtained with different injection volume and chromatographic conditions

Figure 2 : LDL based on 3 times noise ratio

Time	Acetic	Formic	H2S	COS	N2O
/2015 04:51:21	0.267	0.190	3.080	3.040	2.361
/2015 04:32:35	0.266	0.204	3.080	3.033	2.354
/2015 04:13:50	0.265	0.190	3.071	3.037	2.361
/2015 03:55:04	0.263	0.224	3.096	3.037	2.354
/2015 03:17:33	0.264	0.189	3.080	3.040	2.345
/2015 02:40:02	0.266	0.178	3.072	3.028	2.338
/2015 02:21:16	0.267	0.159	3.071	3.033	2.330
/2015 02:02:31	0.268	0.190	3.064	3.028	2.325
/2015 01:43:45	0.268	0.189	3.059	3.025	2.330
/2015 01:24:59	0.269	0.186	3.054	3.018	2.330
/2015 01:06:13	0.270	0.190	3.046	3.017	2.327
/2015 00:47:27	0.271	0.178	3.042	3.014	2.329
/2015 00:28:41	0.271	0.178	3.039	3.018	2.327
/2015 00:09:55	0.273	0.171	3.037	3.017	2.331

Figure 3 :
Repeatability results

CONCLUSION:

Using a solution combining the PlasmaDetek 2 and the MultiDetek 2 is the best way to achieve sensitivity, robustness and speed in an industrial or laboratory compact system for air analysis.

APPLICATION NOTE

LD16-13



Measurement of Greenhouse gases GHG



Energy (fossil fuel) and agriculture required for human activities on Earth produce Greenhouse gases (GHG) such as Carbon Dioxide (CO₂), Methane (CH₄), Nitrous Oxide (N₂O) and Fluorinated gases mainly Sulfur Hexafluoride (SF₆). These gases tend to absorb infrared radiation emitted by the Earth surface resulting to reduce the atmospheric heat loss into space and keeping Earth warmer.

The source of every GHG type is associated to different sectors resulting of human activities:

CO₂ → *Fossil fuel, industrial processes, forestry, land use for agriculture*

CH₄ → *Agriculture, waste management, energy use, biomass burning*

N₂O → *Agriculture (such as fertilizer use) and biomass burning*

F-gases (SF₆) → *Industrial processes and refrigeration*

For this reason, the Kyoto Protocol was established in 1997 by the industrialized countries with an objective to measure, control and decrease the GHG in order to reduce the continuous global warming.

Figures 1, 2 and 3 show some data that demonstrate the impact of human activities to increase the Greenhouse gases level worldwide.

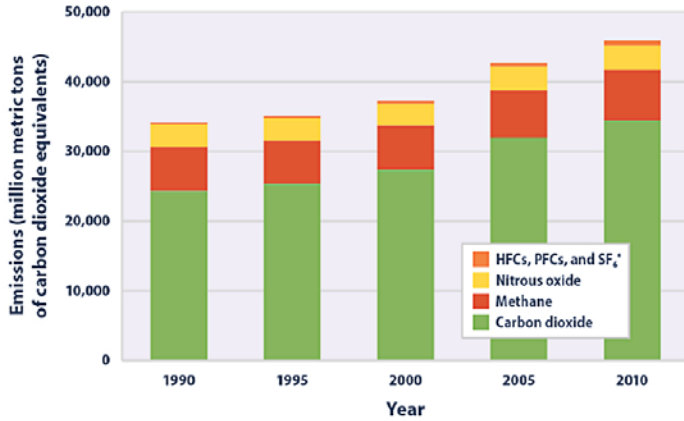

Figure 1:
Global Greenhouse gas emissions by gas type, 1990-2010

(Data sources WRI 2014, FAO 2014) ¹

This figure shows worldwide emissions of carbon dioxide, methane, nitrous oxide and several fluorinated gases from 1990 to 2010. For consistency, emissions are expressed in million metric tons of carbon dioxide equivalents. These totals include emissions and sinks due to land-use change and forestry.

*HFCs are hydro fluorocarbons, PFCs are per fluorocarbons and SF₆ is hexafluoride

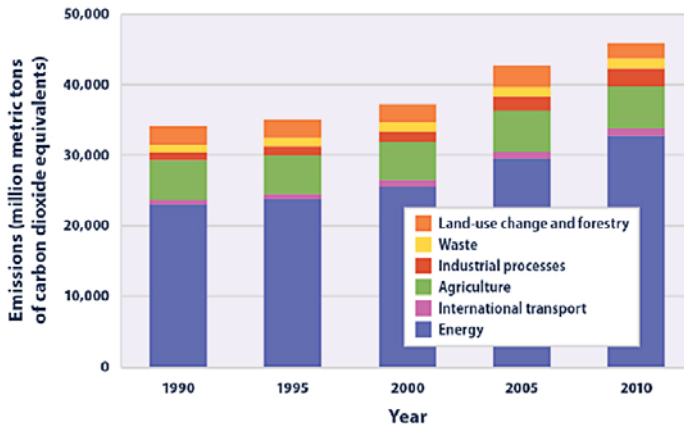

Figure 2:
Global Greenhouse gas emissions by sector, 1990-2010

(Data sources WRI 2014, FAO 2014) ¹

This figure shows worldwide gas emissions by sector from 1990 to 2010.

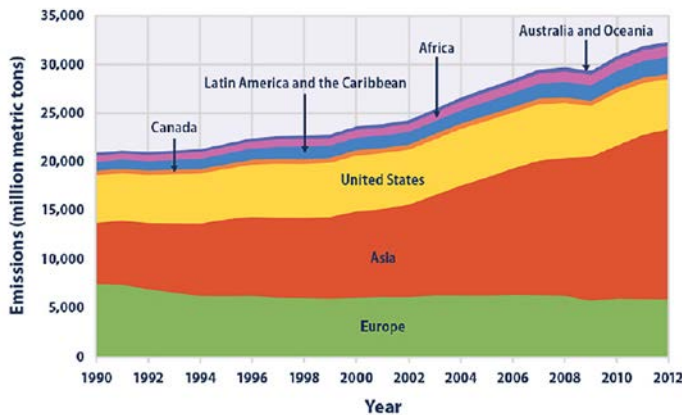

Figure 3:
Global Greenhouse gas emissions by regions, 1990-2012

(Data sources WRI 2015) ¹

This figure shows carbon dioxide emissions from 1990 to 2012 for different regions of the world.

¹Data and analysis come from the World Resources Institute's Climate Analysis Indicators Tool (CAIT), which compiles data from peer reviewed and internationally recognized greenhouse gas inventories developed by EPA and other government agencies worldwide.

The well known technique to measure and quantify the GHG is Gas Chromatography. It can determine the rate of emission or absorption. These rates are mainly measured using samples of soil, rice, maize or wheat from different areas. The measurement of ambient air is also used. The worldwide GHG can then be better measured and controlled to facilitate the proper actions to be taken to reduce the global warming.

ALTERNATIVE SOLUTION USING GAS CHROMATOGRAPH

The use of multiple detectors in a gas chromatography system is generally necessary to cover the greenhouse application.

A FID detector and a methanizer system for detection of trace impurities of Methane (CH₄) and Carbon Dioxide (CO₂). Such detector requires Fuel (H₂), Air and the carrier gas source to make it works.

An ECD detector to measure traces Nitrous Oxide (N₂O) and Sulfur Hexafluoride (SF₆). This type of detector is a source of radioactivity and results in complication for storage, handling and transport.

A TCD is also required for measuring high concentration Carbon Dioxide (CO₂) when necessary.

It is then a solution combining multiple types of detection technology which makes the system more complex to operate and increases the operating cost.

OUR SOLUTION

Using the PlasmaDetek2 (PED) plasma detector and the MultiDetek2 compact gas chromatograph, the analysis of the most critical trace impurities in air can be achieved in one unit with a single detection technology (PED).

By default, the configuration has 2 channels to cover the analysis of Methane, Carbon Dioxide, Nitrous Oxide and Sulfur Hexafluoride. If additional options for the analysis of other impurities like fluorinated gases (F-gases) are required, then an additional channel still using a Plasma Emission Detector can be added in the same instrument.

Channel#1: This channel measures 0-1000ppm Methane (CH₄) and 0-5000ppm Carbon Dioxide (CO₂) using the PlasmaDetek2 (PED). Other measuring ranges can be configured. The system is protected against moisture using a pre column in back flush to vent configuration.

Channel#2: 0-10ppm Sulfur Hexafluoride (SF₆) and Nitrous Oxide (N₂O) still uses the PlasmaDetek2 (PED). Other ranges are also possible. A pre column to protect the system against moisture is also used in this channel.

Channel#3 (optional): Analysis of other fluorinated gases (F-gases) that would still be using the PlasmaDetek2 (PED) as detector.

The sample preparation is managed by the HTA Headspace auto sampler system mounted on the MultiDetek2 GC. The auto sampler tray configuration can be for 14 or 42 vials having size range of 10ml or 20ml depending of the application requirements. The oven can accept 1 or 6 vials for heating and shaking in preparation of analysis. The auto sampler offers syringe auto cleaning and a purge routine in between each sample collection. The syringe volume can be 2.5ml or 5ml depending of the application.

The Headspace can be controlled from its keypad, touch screen interface or from the software environment installed on an external PC or in the integrated PC of the MultiDetek2.

The data management is done with the MultiDetek2 interface. The unit can be control locally from the MultiDetek2 touch screen interface or remotely using LAN connectivity.

RESULTS

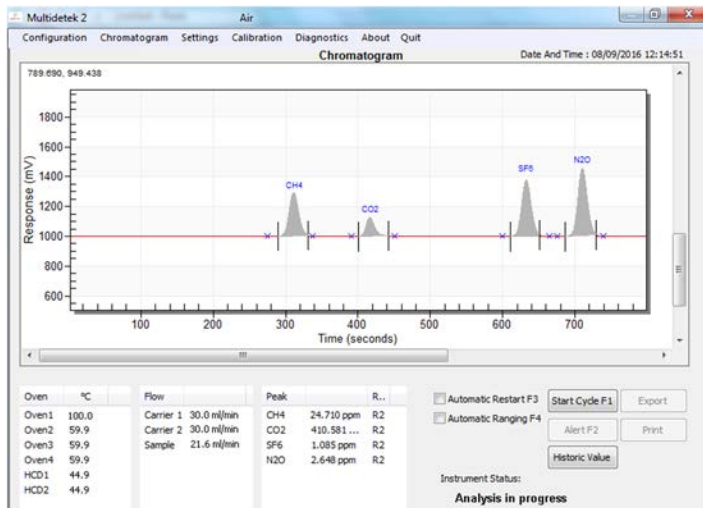

Figure 1: chromatogram of trace impurities in balance air coming from a certified gas bottle.

For this application, a measuring range of 0-1000ppm was required for the CH4 with a LDL of 200ppb.

A measuring range of 0-5000ppm was required for the CO2 with a LDL of 500ppb.

A measuring range of 10ppm was required for the SF6 and N2O with a LDL of 20ppb.

The figure 2 shows a table where the LDL calculation was obtained with a noise/response ratio. It shows the system can achieve better specifications than what was required for the application. Lower detection limits can be obtained with the same system just by changing the injected sampling loop volume. An extended range with lower detection limit capabilities can be obtained with our optional multiple sampling loop injection system.

It becomes possible to measure ppt/ppb/high ppm with the same detector in the same instrument.

COMPONENT	CONCENTRATION	PEAK HEIGHT	NOISE	LDL (3X NOISE)
CH4	24.710 ppm	331 mV	0.4 mV	89.6 ppb
CO2	410.581 ppm	177 mV	0.06 mV	417.5 ppb
SF6	1.085 ppm	389 mV	1.6 mV	13.4 ppb
N2O	2.648 ppm	479 mV	0.9 mV	14.9 ppb

Note: other LDL could be obtained with different injection volume and chromatographic condition

Figure 2

CONCLUSION

The combination of the PlasmaDetek2 (PED) detector with the MultiDetek2 compact gas chromatograph and the HTA Headspace auto sampler becomes an interesting reliable and robust solution for the laboratory requirements where Greenhouse (GHG) gases must be measured.

APPLICATION NOTE

LD19-06



VOCs measurement in the air



MultiDetek2 ▲

The analysis of indoor/outdoor air quality is becoming an important part of our day-to-day priorities due to the increasing contaminant level caused by the industrial processes. The main contaminants to be controlled in the air are the VOCs (volatile organic compounds).

VOCs are human-made contaminants used and produced in the processing of product manufacturing as paints, adhesives, petroleum products, pharmaceuticals, and refrigerants. This includes emissions from automotive and industrial activity among other sources.

This classification includes different compound groups with various structural characteristics and chemical properties:

- ▶ **Halogenated hydrocarbons**
- ▶ **Aromatics**
- ▶ **Acrylates**
- ▶ **Acetates**
- ▶ **Ketones**
- ▶ **Ethers**
- ▶ **Nitriles**
- ▶ **Sulfides**

Many of these compounds contaminate our environment today. Acceptable exposure limits and regulations for the release of VOCs to the environment are provided by the EPA and other regulatory bodies.

The most common technique used to detect, identify and quantitate VOC is gas chromatography coupled with an FID (flame ionization detector).

LDETEK SOLUTION

The MultiDetek2 compact GC, configured with one FID can offer multiple methods for the analysis of VOCs in the air. This document will show the most common configuration for the air quality monitoring.

The first channel having an injection valve and an arrangement of columns is used for the analysis of trace CH₄, NMHC and THC. The second channel, having similar configuration of valve/column can be added for the analysis of BTEX when it is required. Both channels merge in the FID for the analysis of the components. The diaphragm valves, the columns and the detector are mounted in their respective isothermal heated area to maintain the temperature and the reading stable.

By default, the system comes with a choice of 2 pre-configured/calibrated methods:

Method 1 → Trace CH₄-NMHC-THC in the air

Method 2 → Trace CH₄-NMHC-THC-benzene-toluene-xylenes in the air

RESULTS

This chromatogram represents the method 2 analysis. It has been performed using a certified gas bottle containing 105mg/NM³ CH₄, 93.7mg/NM³ benzene, 95.3mg/NM³ toluene and 96mg/NM³ xylenes in a balance of air. The response time for complete analysis of VOC + BTEX is below 4 minutes. The NMHC are calculated and offered when required. The results for the method 1 are the same, except that the measured impurities are CH₄-NMHC-THC only. The analysis time is then reduced to 1 minute for the method 1.

PEAK	UNIT	CALIBRATION VALUE	_AREA COUNTS
CH ₄	mg/Nm ³	105.00	15784
THC	mg/Nm ³	105.00	1837
Benzene	mg/Nm ³	93.70	13519
Toluene	mg/Nm ³	95.30	17703
Xylenes	mg/Nm ³	96.00	78188

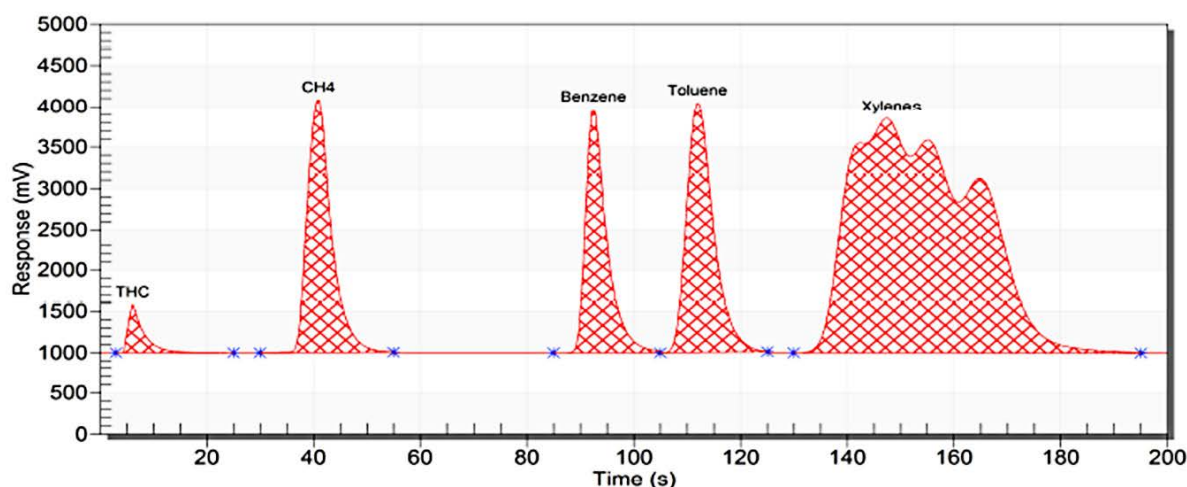

LIMIT OF DETECTION

Running at low concentration, the ldl value is identified as being 3 times the noise level. Refer to the chromatograms and chart below.

COMPONENT	CONCENTRATION	PEAK HEIGHT	NOISE AVERAGE	LDL (3X NOISE)
THC	1.0mg/NM3	12mV	0.2mV	0.050mg/NM3
CH4	0.225mg/NM3	5.5mV	0.4mV	0.049mg/NM3
Benzene	0.332mg/NM3	7.5mV	0.3mV	0.040mg/NM3
Toluene	0.338mg/NM3	6.9mV	0.25mV	0.037mg/NM3
Xylenes	0.176mg/NM3	15mV	1.5mV	0.053mg/NM3

Note: other LDL could be obtained with different injection volume and chromatographic condition

LOW CONCENTRATION CHROMATOGRAM

NOISE BASELINE IDENTIFICATION

THC: 1.5mg/NM3

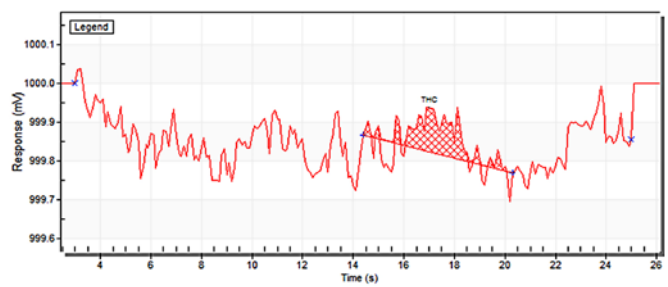
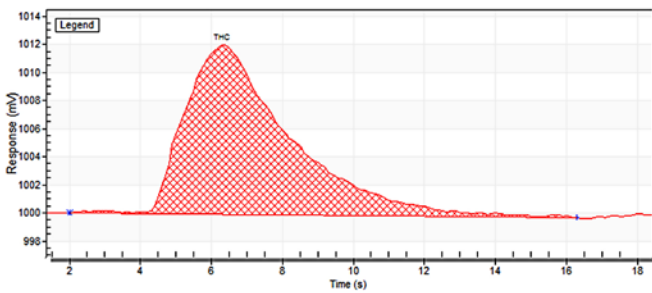

CH4: 0.225mg/NM3

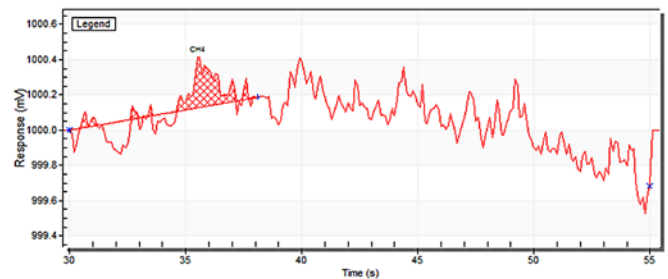
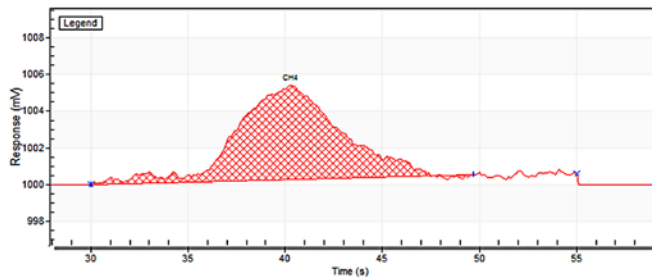

Benzene: 0.332mg/NM3

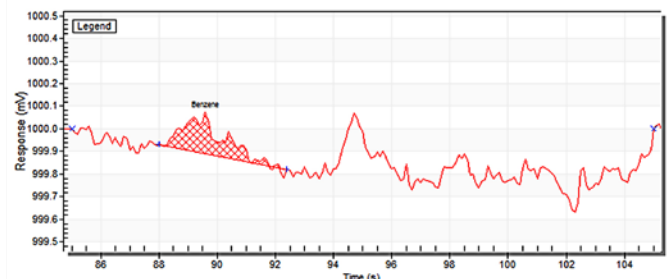
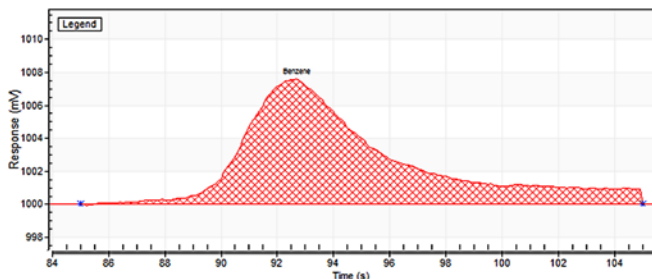

Toluene: 0.338mg/NM3

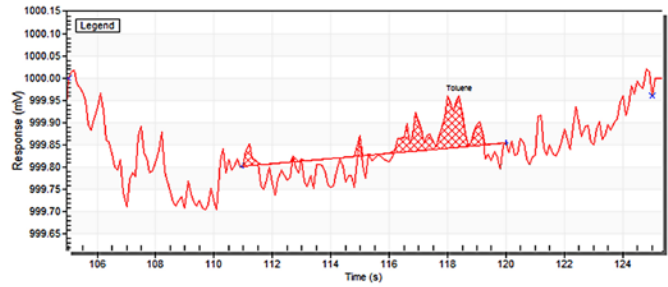
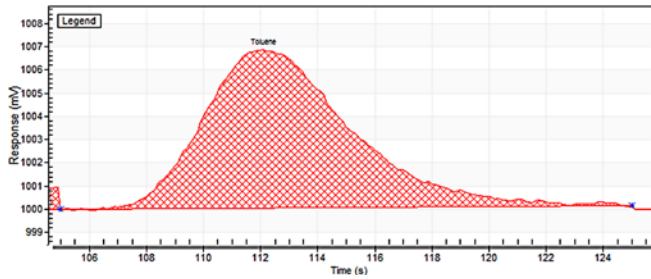

Xylenes: 0.576mg/NM3

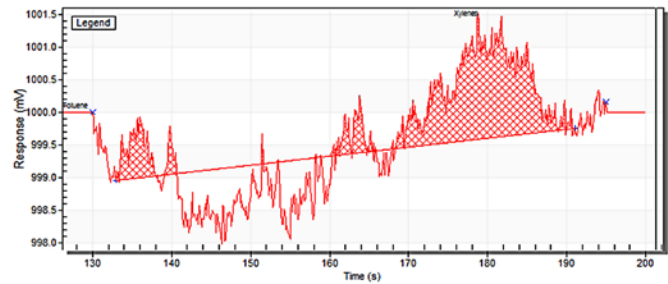
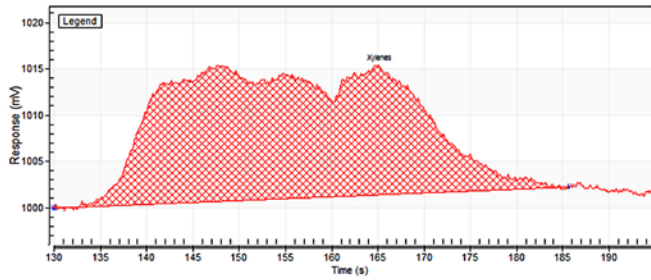

REPEATABILITY

A value of $CV\% \times 3 < 5\%$ for a series of consecutive analysis at a fix concentration in a balance gas of air has to be performed. Refer to the charts below.

COMPONENTS	Repeatability (CV% x 3)
NMHC	0.59%
THC	0.58%
CH4	0.46%
Benzene	0.52%
Toluene	0.48%
Xylenes	0.23%

ANALYSES

Start	NMHC	THC	CH4	Benzene	Toluene	Xylenes
2019-09-13 08:07	259.962 mg/Nm3	263.538 mg/Nm3	3.575 mg/Nm3	3.164 mg/Nm3	3.222 mg/Nm3	15.617 mg/Nm3
2019-09-13 08:03	258.758 mg/Nm3	262.330 mg/Nm3	3.572 mg/Nm3	3.166 mg/Nm3	3.221 mg/Nm3	15.607 mg/Nm3
2019-09-13 08:00	258.895 mg/Nm3	262.466 mg/Nm3	3.570 mg/Nm3	3.169 mg/Nm3	3.218 mg/Nm3	15.601 mg/Nm3
2019-09-13 07:56	258.861 mg/Nm3	262.427 mg/Nm3	3.566 mg/Nm3	3.174 mg/Nm3	3.216 mg/Nm3	15.584 mg/Nm3
2019-09-13 07:53	259.375 mg/Nm3	262.943 mg/Nm3	3.568 mg/Nm3	3.174 mg/Nm3	3.216 mg/Nm3	15.583 mg/Nm3
2019-09-13 07:50	259.759 mg/Nm3	263.328 mg/Nm3	3.569 mg/Nm3	3.177 mg/Nm3	3.211 mg/Nm3	15.594 mg/Nm3
2019-09-13 07:46	259.381 mg/Nm3	262.952 mg/Nm3	3.571 mg/Nm3	3.182 mg/Nm3	3.206 mg/Nm3	15.580 mg/Nm3
2019-09-13 07:43	259.111 mg/Nm3	262.681 mg/Nm3	3.570 mg/Nm3	3.190 mg/Nm3	3.207 mg/Nm3	15.571 mg/Nm3
2019-09-13 07:39	259.326 mg/Nm3	262.899 mg/Nm3	3.573 mg/Nm3	3.190 mg/Nm3	3.209 mg/Nm3	15.561 mg/Nm3
2019-09-13 07:36	258.653 mg/Nm3	262.222 mg/Nm3	3.568 mg/Nm3	3.189 mg/Nm3	3.207 mg/Nm3	15.559 mg/Nm3

Model : MultiDetek2
 Serial Number : MD2-67719
 Method : VOC + BTEX

CONCLUSION

Using our MultiDetek2 GC combined with our FID, the air quality monitoring can be performed quickly using the well-known international standards for the detection of VOCs. The unit design is compact, robust and offering all the standard industrial communication protocols.

APPLICATION NOTE

LD20-09



Trace hydrocarbons (THCs/VOCs) with MultiDetek2 and FID



▲ MultiDetek2

Measuring hydrocarbons using a flame ionization detector (FID) with the MultiDetek2 gas chromatograph instrument.

Combining our FID with our high performance adjustable amplification system, the measure of organics in low ppb up to high ppm becomes an easy task. Our high performance sub femto amp. current amplifier with its filtering stages ensure to achieve low sensitivity by keeping the stability of the unit at the best level. Our module is built in a shielded encapsulated environment to offer the best robustness and leaving the interferences away from the signal.

The FID/amplifier modules are mounted in our MultiDetek2 rackmount analyzer which is constructed for the industrial market.

The range of application can go from ASU for monitoring hydrocarbons in bulk gases to environmental applications for measuring VOCs for indoor/outdoor ambient polluted air and industrial stacks.

The Multidetek 2 is providing all communication protocols used in the industry (Modbus, Profibus, RS-485, 4-20 mA, etc) to ensure compatibility with any acquisition system.

RESULTS:

Chromatograms:

Sample: 1000ppb CH4 Balance air

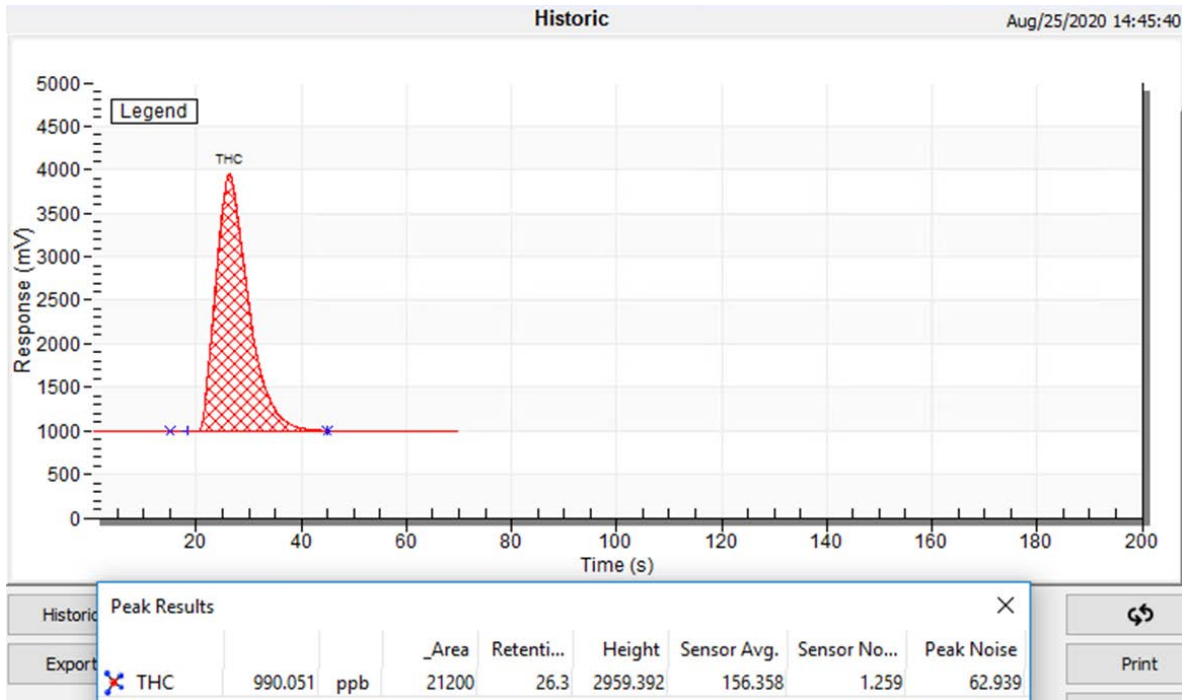

Sample: 500ppb CH4 Balance air

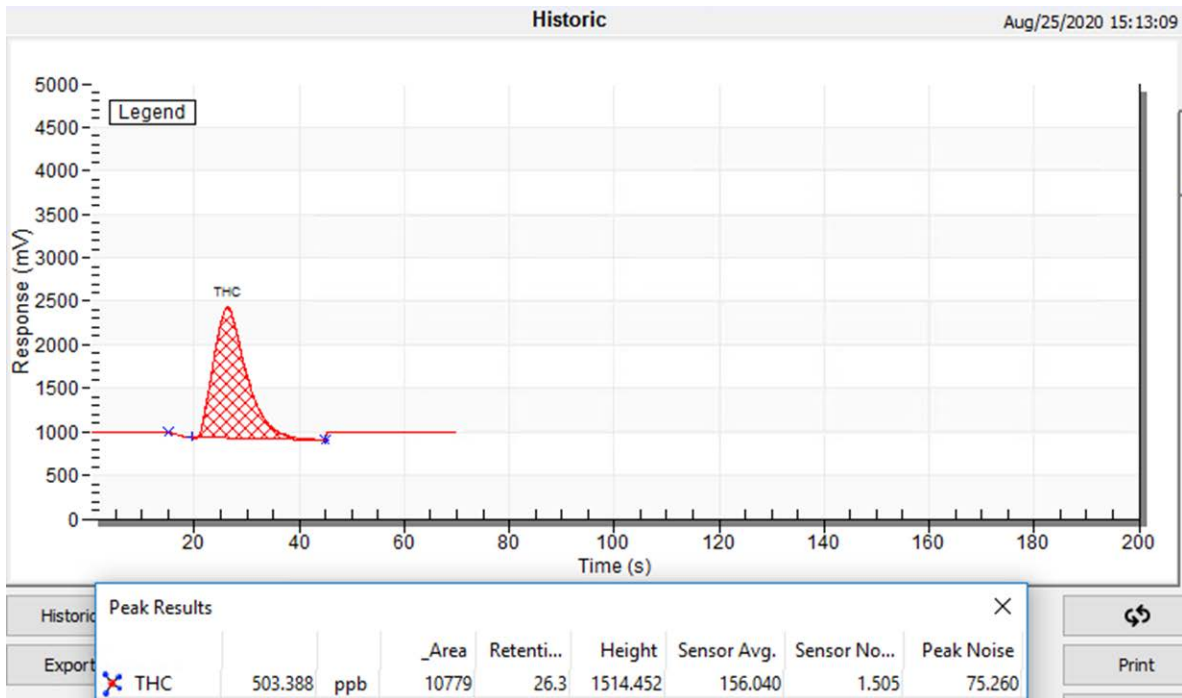

Sample: 100ppb CH4 Balance air

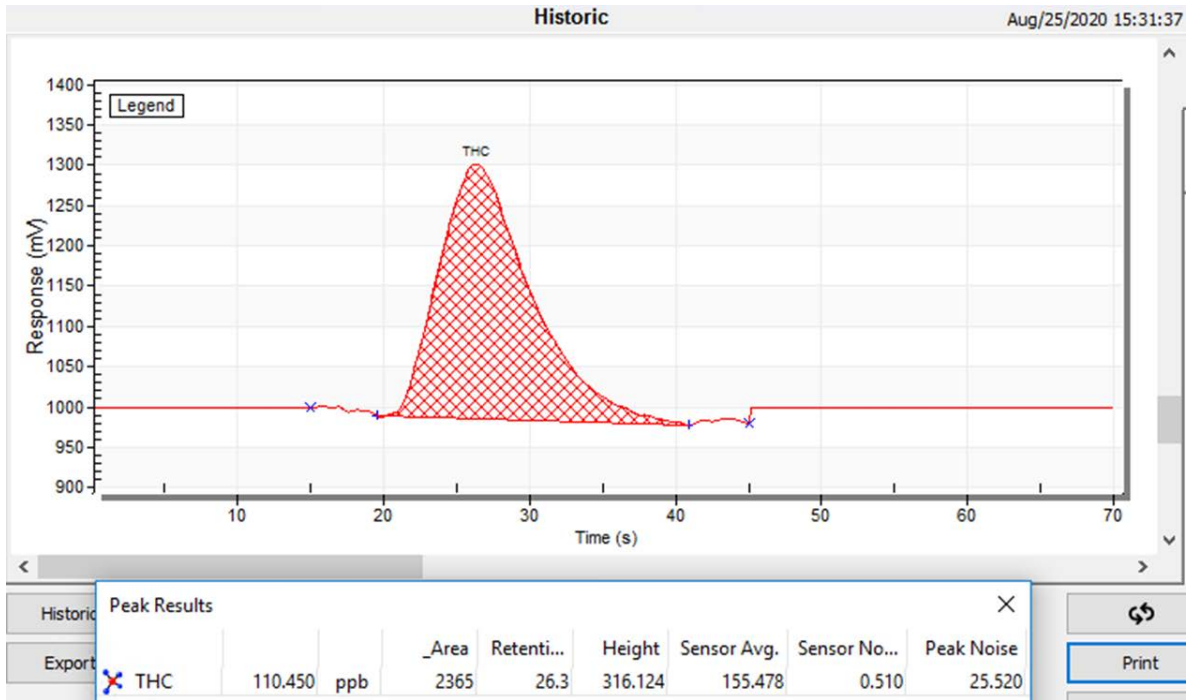

Sample: 50ppb CH4 Balance air

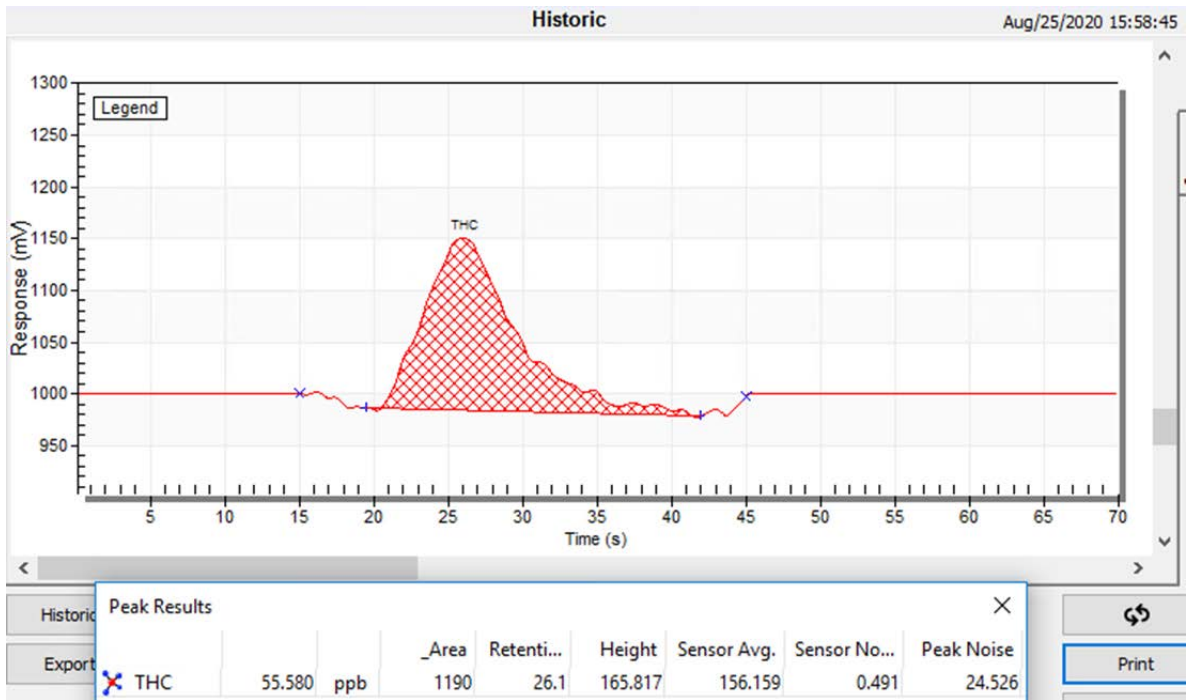

Sample: 25ppb CH4 Balance air

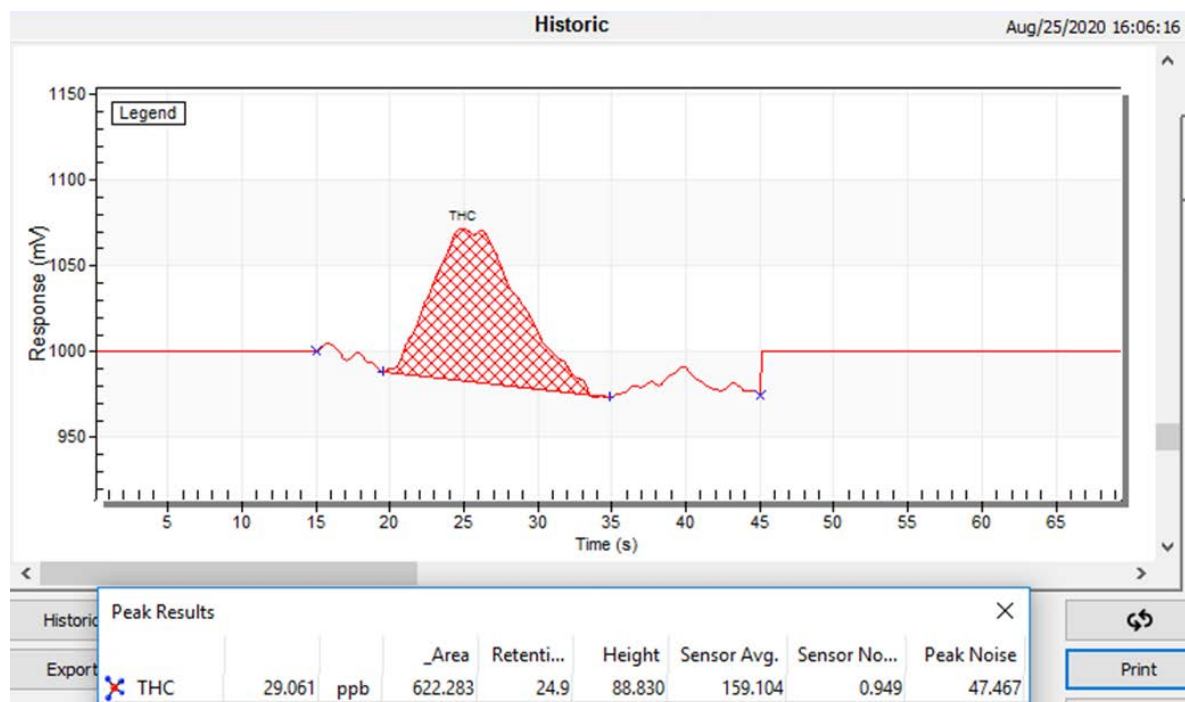

Sample : 100ppb Benzene (C6H6) Balance air

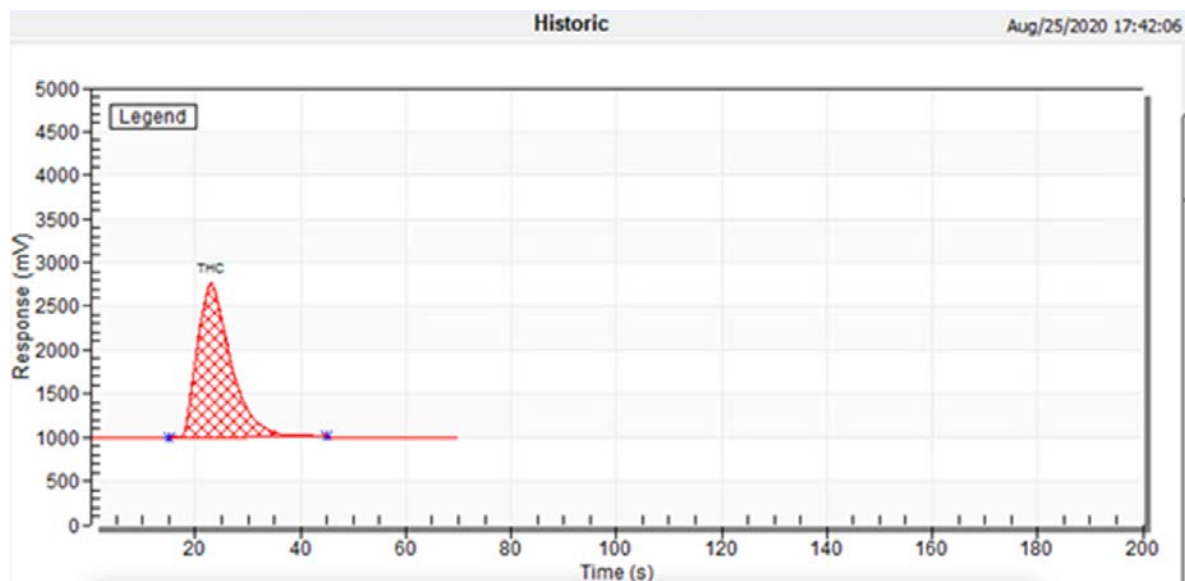

Sample : 10ppb Benzene (C6H6) Balance air

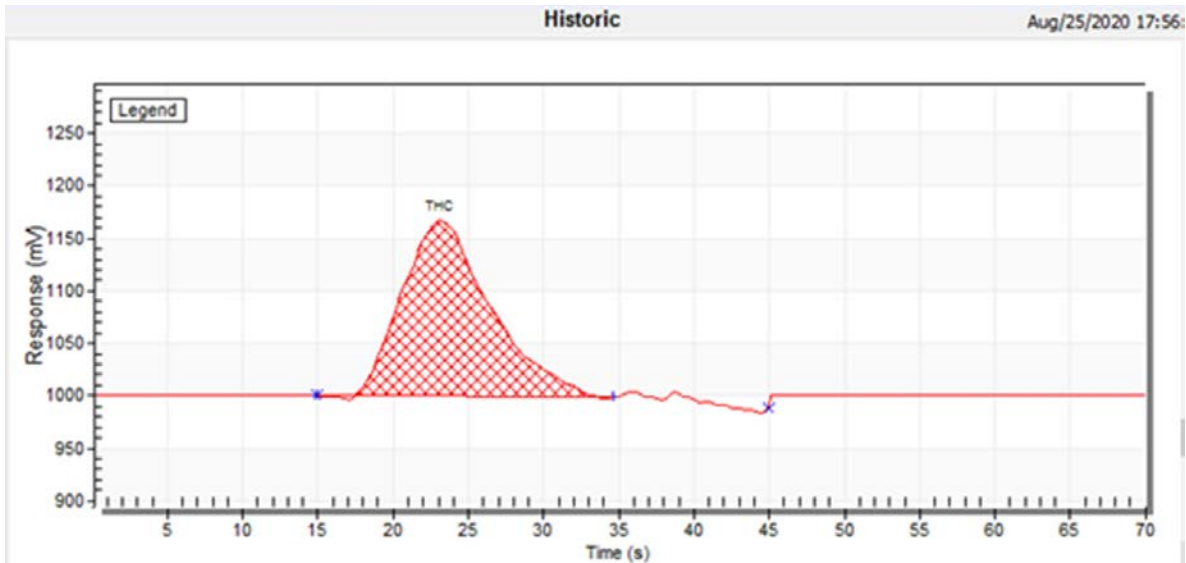

Sample (blank) : Raw noise analysis

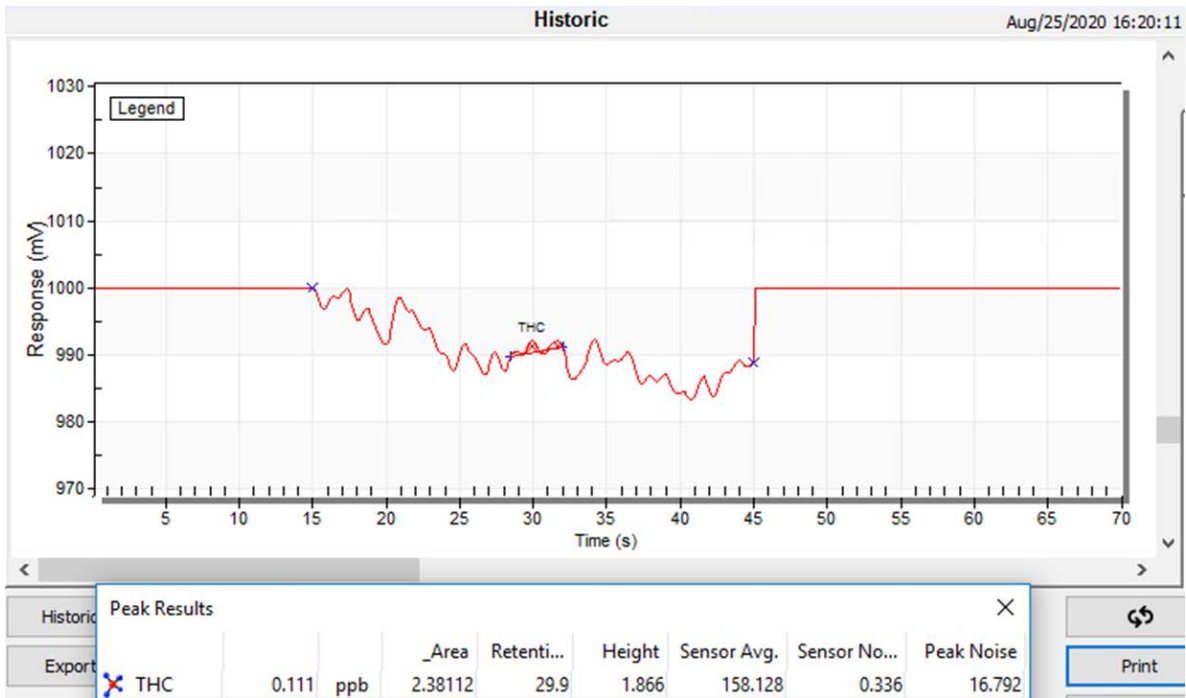

LDL:

COMPONENT	CONCENTRATION (ppb)	PEAK HEIGHT (mV)	NOISE (mV)	LDL (3x Noise) (ppb)
THC/VOC by CH4 reference	100	316	16.79	15
THC/VOC by C6H6 reference	100	1788	16.79	3

Note: other LDL could be obtained with different injection volume and chromatographic condition

REPEATABILITY:

	Description	THC
) Historic		
[-] Tue, Aug-25-2020		
	11:21:07	126.137
	11:20:01	126.258
	11:18:56	125.468
	11:17:51	124.010
	11:16:46	123.230
	11:15:41	126.643

Impurities	THC/VOC
Average (ppb)	125,291
Sigma σ (ppb)	1.37
CV (%)	1.09
CV x 3 (%)	3.28
Status	pass
Repeatability (%)	1

Using a series of 6 consecutive analysis, the repeatability conformity test must be below 5% considering a value of 3 times the coefficient of variation (CV) to be accepted.

The repeatability % is obtained by applying the sigma of the 6 consecutive analysis on the average of these 6 same analysis.

LINEARITY:

Response area (counts)	Concentration (ppb)
0	0
622	29
1190	55
2365	110
10779	503
21200	990

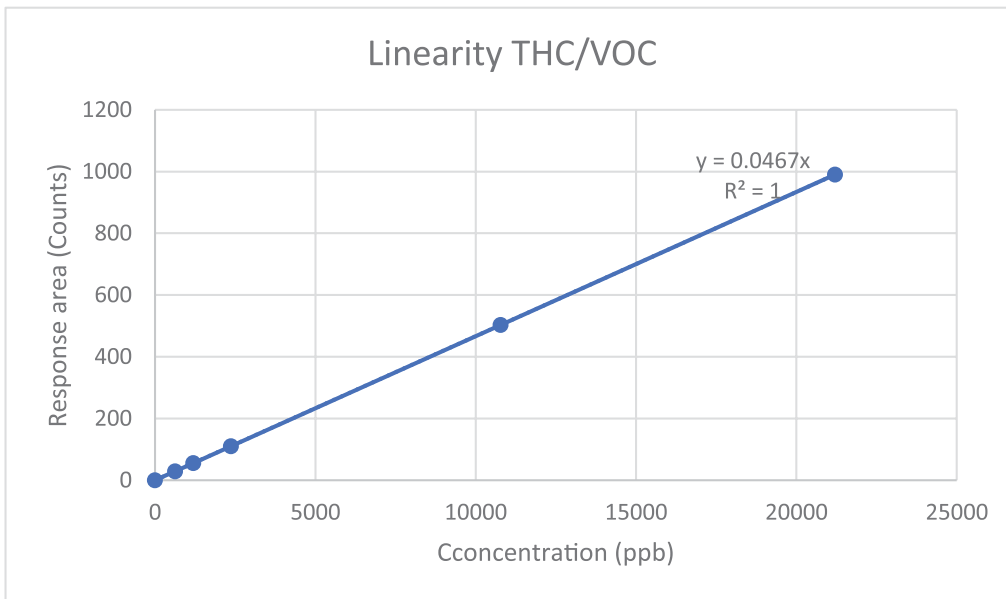

CONCLUSION:

The MultiDetek2 gas analyzer configured with its FID/amplification modules is a solution for a quick analysis (less than a minute) for trace THC/VOCs in air. This type of instrument is simple and reliable. The equipment comes with a touchscreen panel PC interface with all the standard industrial communication protocols. The unit can cover a wide range of analysis from low ppb up to high ppm what is generally required for the analysis of the volatile organics(VOCs) in air for pollution monitoring. Different organics can be measured depending of your application. Don't hesitate to contact our experts to know more about it.



3.0 APPLICATION NOTE

3.2 INDUSTRIAL GAS



3.0 APPLICATION NOTES

APPLICATION NOTE

LD12-02



Analysis of permanent gases and light hydrocarbons with the PlasmaDetek

The PlasmaDetek is ideal to measure permanent gases and light hydrocarbons in different matrices. Only one detector system is needed to accomplish this task. Such measurement is required in many different applications field: industrial, petrochemical, energy, environmental, etc. The sensitivity, the stability, the ease of start-up and installation make this system very attractive for any users.

PLASMADETEK CONFIGURATION:

The PlasmaDetek is configured with two outputs signal to be able to detect all components. Both argon or helium carrier gas can be used.

- Output 1 : H₂, C₁ to C₄
- Output 2 : O₂, N₂, CO, CO₂

No need of fuel, air, doping gas, methanizer or other devices with the system. This is a stand-alone detector system that requires only carrier gas to make the measurement of each compound.



Figure 1:
▲ PlasmaDetek detector

CHROMATOGRAPHY CONFIGURATION:

To make the measurement of all components described above, figure 2 describes an easy configuration. Only one 10 ports injection valve and one selection valve are used. One RT Molecular Sieve 5A 30m x 0.53mm(column 2) separates H₂, O₂, N₂, CH₄, CO before being measured by the detector. The other column, a RT Alumina Bond 30m x 0.53mm x 10mm(column 1), does the same for the CO₂ and C₁ to C₄.

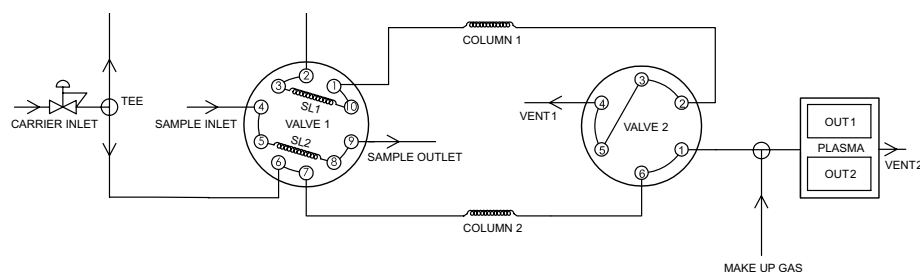

- 1 x 10 ports injection valve
- 1 x 6 ports valve for channel selection
- 1 x RT Alumina Bond 30m x 0.53mm x 10mm (column 1)
- 1 x RT Molecular Sieve 5A 30m x 0.53mm (column 2)
- Argon or helium carrier
- Carrier Flow : 4 cc/min
- Make-up : 60 cc/min
- Detector : PlasmaDetek two outputs

Figure 2: Plumbing configuration for H₂,O₂,N₂,CO, C₁ to C₄ in Helium or Argon

RESULTS AND PERFORMANCE:

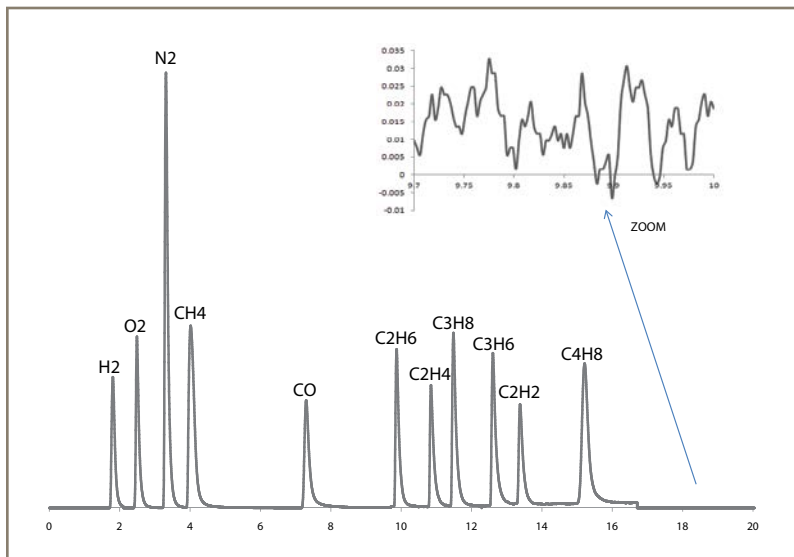

Figure 3 shows the chromatogram obtained from this configuration. The chromatograph uses output 1 to measure H₂ and the HC's and output 2 for the others.

Figure 3: 10ppm H₂ - O₂ - N₂ - CH₄ - CO - C₂H₆ - C₂H₄ - C₃H₈ - C₃H₆ - C₂H₂ - C₄H₈

COMPONENT	CONCENTRATION	PEAK HEIGHT	NOISE	S/N	LOD (ppb) S/N = 3	LOQ (ppb) S/N = 5
H ₂	10 ppm	342 mV	0.039 mV	8769	3.4	5.7
O ₂	10 ppm	450 mV	0.039 mV	11538	2.6	4.3
N ₂	10 ppm	1142 mV	0.039 mV	29282	1.0	1.7
CH ₄	10 ppm	576 mV	0.039 mV	14769	2.5	4.1
CO	10 ppm	282 mV	0.039 mV	7230	4.1	6.9
C ₂ H ₆	10 ppm	402 mV	0.039 mV	10307	2.9	4.9
C ₂ H ₄	10 ppm	330 mV	0.039 mV	8461	3.6	5.9
C ₃ H ₈	10 ppm	442 mV	0.039 mV	11333	2.6	4.4
C ₃ H ₆	10 ppm	426 mV	0.039 mV	10923	2.7	4.6
C ₂ H ₂	10 ppm	274 mV	0.039 mV	7025	4.3	7.1
C ₄ H ₈	10 ppm	366 mV	0.039 mV	9384	6.4	5.4

Figure 4: LOQ and LOD calculation

Figure 4 shows the performance of the PlasmaDetek for such components obtained with the configuration described above. Those results and performances depend on the chromatographic system and conditions of operation.

CONCLUSION:

With the PlasmaDetek, we can measure permanent gases and C₁-C₄ with only one detector. This is a very cost effective solution in terms of gas supply, plumbing configuration and time consuming. The performance is indisputable. Application in ppb is now easy to make with such configuration.

Selectivity on some impurities can also be configured in the PlasmaDetek to make Chromatography easier when working on different background or focus on some impurities. Heavier hydrocarbons can also be measured. Please contact LDetek for more information.

APPLICATION NOTE

LD12-03



Analysis of argon in pure oxygen with the PlasmaDetek and ArgoTek

The complexity of measuring argon as impurity in chromatography comes from the fact that typical columns on the market do not separate argon and oxygen. Both elute at the same time making the analysis difficult in low concentration. There are typical techniques for this measurement:

- Using an oxygen trap which involves regeneration procedure with H₂ supply, maintenance, consumable and complex chromatography system.
- Cryogenic configuration where columns need to be used in cold environment which involves complex manipulation.
- Using an online oxygen analyzer in parallel and subtract the oxygen from the measurement of Ar+O₂. But this requires a second analyzer and it is difficult to get an accurate measurement in low concentration.

But the combination of the PlasmaDetek and the ArgoTek column is the ideal solution to measure argon in ppt to %.

PLASMADETEK CONFIGURATION:

The PlasmaDetek is configured with one output signal to be selective to argon. The detector system becomes more sensitive to argon than oxygen by at least a factor of 10.

This is a stand-alone detector system that requires only helium carrier gas to make the measurement. No need of doping gas or other devices to make it selective to argon against oxygen.



▲ PlasmaDetek detector

CHROMATOGRAPHY CONFIGURATION:

This measurement is done by using a simple backflush to vent configuration. The ArgoTek (column 1) is used to separate the argon from oxygen. The argon comes out first of the column and it is sent to the detector. When the argon is out of the ArgoTek, we simply flush outside the oxygen.

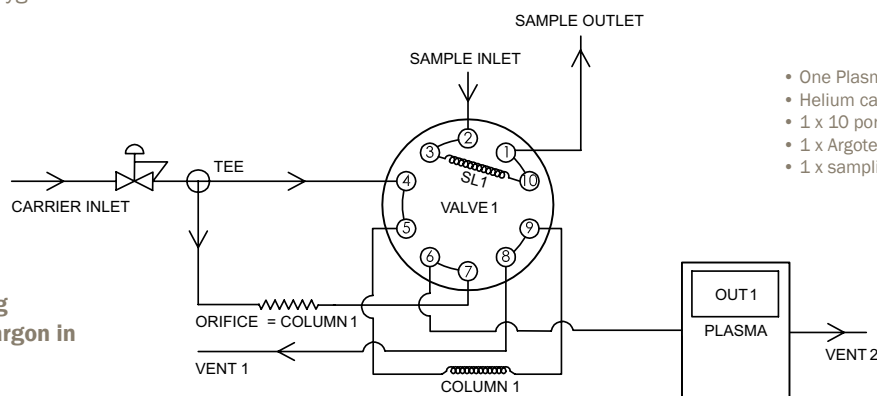

Figure 1: Plumbing configuration for argon in pure oxygen

- One PlasmaDetek selective to Argon
- Helium carrier gas: 30cc/min
- 1 x 10 ports diaphragm valve
- 1 x ArgoTek column
- 1 x sampling loop: 20 µl

RESULTS AND PERFORMANCE:

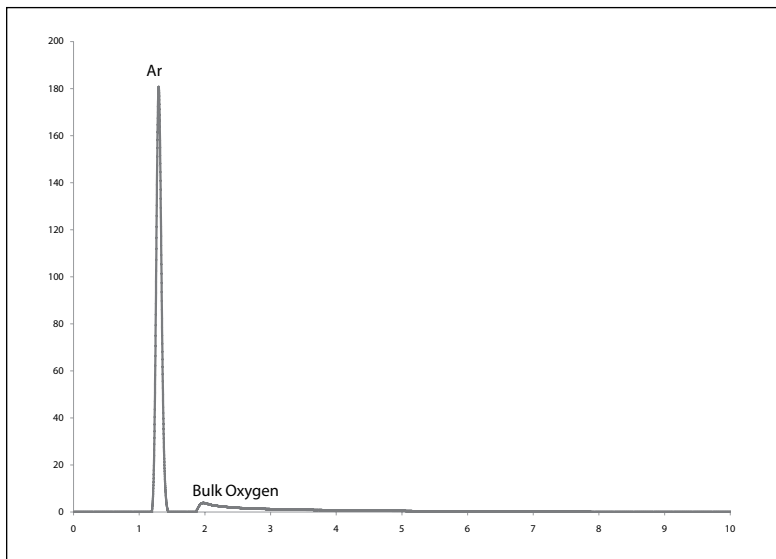

Figure 2 shows the chromatogram obtained from this configuration. The low concentration of argon impurity is easily separated from the oxygen bulk. But more importantly, the selectivity of argon with the detector, gives a better separation of the two compounds, which allows a faster recovery time.

Figure 2: 1 ppm Argon in pure Oxygen

COMPONENT	CONCENTRATION	PEAK HEIGHT	NOISE	S/N	LOD (ppb) S/N = 3	LOQ (ppb) S/N = 5
Ar	1 ppm	180 mV	0.039 mV	4615	0,65	1

Figure 3: LOQ and LOD calculation

Figure 3 shows the performance of the system obtained with the configuration described above. This PlasmaDetek and ArgoTek combination gives ppt limit of detection with no oxygen interference. Higher concentration, up to %, can be also measured by simply changing the sample volume.

CONCLUSION:

Using the Argotek and PlasmaDetek combination, it becomes very easy to measure this compound compared to other available technologies. This is a cost effective, maintenance free configuration and quick analysis technique avoiding consumables and regeneration procedures that will reduce complexity of the chromatography system.

APPLICATION NOTE

LD12-04



Analysis of nitrogen in hydrogen and oxygen bulk with the PlasmaDetek

Measuring nitrogen as impurity in low concentration is not an easy task. It is mostly the case in hydrogen and oxygen background. Even if the chromatography system is quite efficient, the remaining bulk gas could influence the reading of nitrogen.

The PlasmaDetek, configured to be selective on nitrogen, brings very good result for this measurement. This document will demonstrate how this technology can help to make better analysis on nitrogen with any gas chromatography system.

PLASMADETEK CONFIGURATION:

The PlasmaDetek has the advantage that it can be configured to be more sensitive on some compounds than the others. This selectivity configuration helps the chromatography to be more effective and easier to setup.

By using proper optical system, the detector becomes selective on nitrogen. No need of doping gas or other devices to make it selective. There is no other such detector on the market that will give this nitrogen selectivity.



▲ PlasmaDetek detector

CHROMATOGRAPHY CONFIGURATION:

A simple backflush configuration is used to make the measurement of N_2 in H_2 or O_2 . Column 1 will initiate a separation of H_2 or O_2 from N_2 and bulk gas will be vented out as much as possible. Before N_2 goes out, the flow is directed to column 2. Both carrier gases can be used: argon or helium.

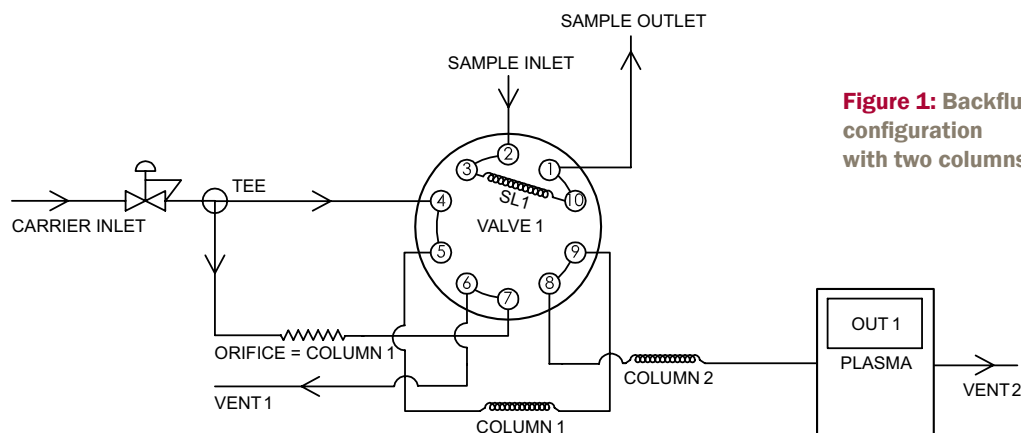

Figure 1: Backflush configuration with two columns

RESULTS AND PERFORMANCE:

Using a 5 ppm standard nitrogen in bulk hydrogen as sample, two chromatograms were generated with the chromatography configuration described above with a helium carrier. **Figure 2** is using a non-selective detector and **figure 3** the PlasmaDetek N₂ selective configuration. As it is clearly shown, the selectivity from the PlasmaDetek is improving the chromatogram. Almost no hydrogen is seen by the detector.

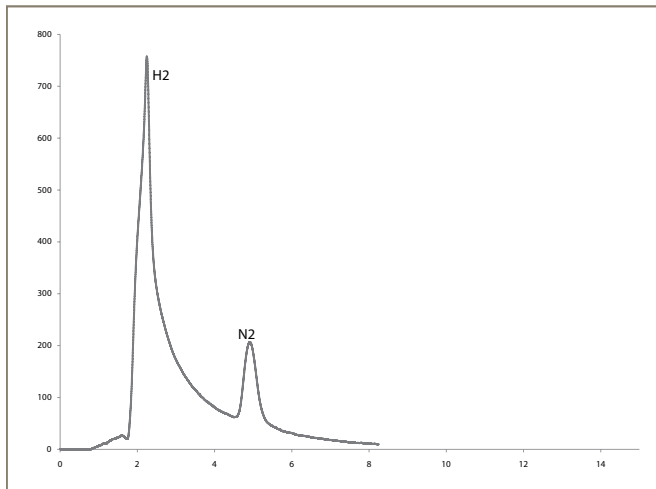

Figure 2: 5 ppm N₂ in H₂ with non-selective detector system

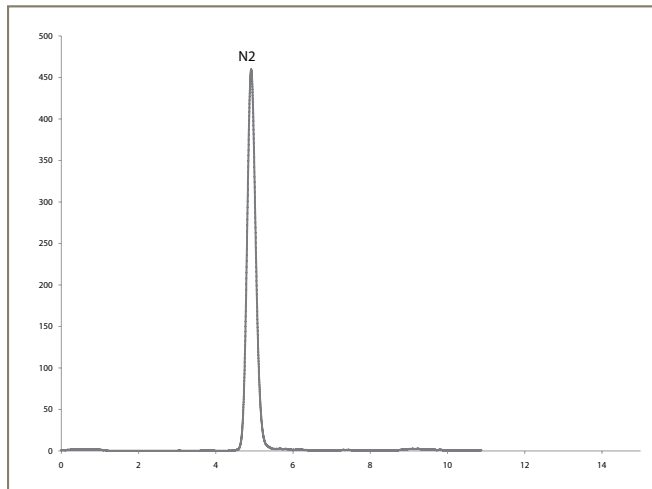

Figure 3: 5 ppm N₂ in H₂ with PlasmaDetek N₂ selective system

Same procedure was done with a standard of 420 ppb nitrogen in oxygen in similar backflush configuration with helium carrier. **Figure 4** and **figure 5** show the comparison with a non-selective detector and the PlasmaDetek N₂ selective configuration. It is also obvious in this case that selectivity helps to have better results and less drifting problem for the peak from remaining bulk.

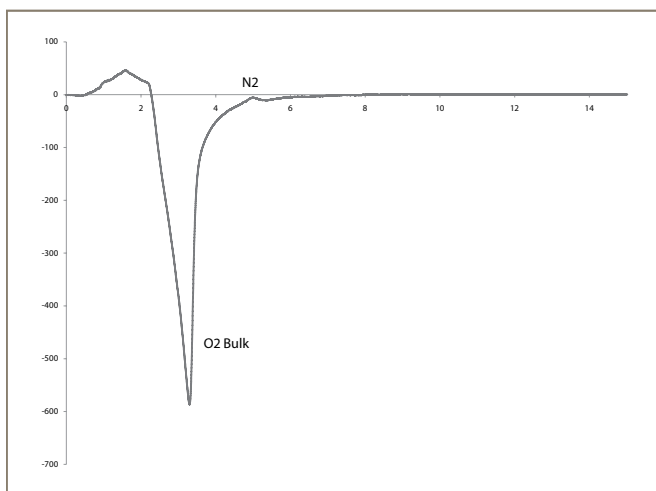

Figure 4: 420 ppb N₂ in O₂ with non-selective detector system

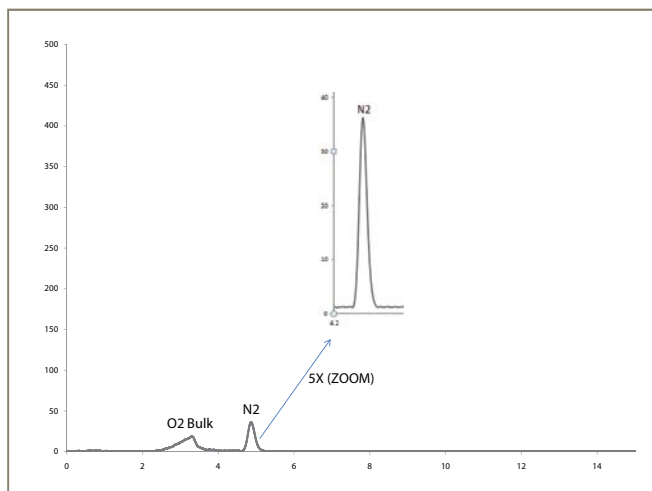

Figure 5: 420 ppb N₂ in O₂ with PlasmaDetek N₂ selective system

Having 79% of nitrogen in air, It is important to ensure that the chromatographic system is leak free. Low concentration nitrogen requires good hardware components to avoid any inboard and outboard leakages. It is even more the case, when measuring in pure H₂ or O₂.



Figure 6: High performance diaphragm valve

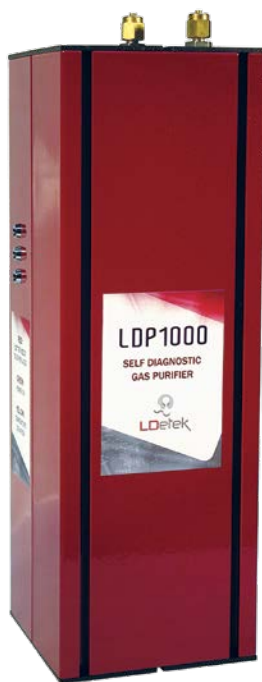

Figure 7: LDP1000 noble gas purifier

Good quality carrier gas is also mandatory to get analysis in low concentration. With its unique specific design, the LDP1000 noble gas purifier is a cost effective device for any gas chromatograph. It eliminates any contamination problems coming from the gas source.

In **figure 8**, we have evaluated the performance of both analysis. With the fact that the PlasmaDetek has a very low noise and a good response on the nitrogen, low concentration can be measured. LOD and LOQ can vary depending on sample volume or condition of operation. < 1 ppb LOD can also be obtained by optimizing the system.

COMPONENT	CONCENTRATION	PEAK HEIGHT	NOISE	S/N	LOD (ppb) S/N = 3	LOQ (ppb) S/N = 5
N ₂ in H ₂	5 ppm	455 mV	0.038 mV	11973	1,25	2,1
N ₂ in O ₂	0.42 ppm	38 mV	0.038 mV	1000	1,26	2,1

Figure 8: LOQ and LOD calculation

CONCLUSION:

This is the ideal configuration to measure nitrogen in different matrices. By having such selectivity, you can reduce analysis time and make fast chromatography. In some cases, consumables such as traps can be avoided. It becomes a cost effective solution, maintenance free system and can give better limit of detection by reducing residual background effect.

The PlasmaDetek can also be configured with multiple selective outputs to allow measurements of different compounds. Please contact LDetek for more information.

APPLICATION NOTE

LD12-06



Increasing argon production with the MultiDetek

Air is composed of nitrogen (78.09%), oxygen (20.94%) and argon (0.934%). To produce pure argon, distillation process separates the air constituent by the use of distillation columns. Such installation on an air separation plant is used for many years.

This separation process is based on vapor pressure of each component. Argon is taken from a low pressure column and introduced in a second column called crude argon. Since argon vapor pressure is close to oxygen, and also between nitrogen and oxygen, its extraction is between those two other components in the low pressure column before being introduced in the second column.

However, the level of nitrogen can be problematic when introducing the extracted gas to the crude argon column. Introducing high volume of nitrogen in the crude argon column will make it stop working. Dumping phenomenon can also arise from the crude argon column.

The extraction of argon in the low pressure column is critical, the goal is to get as much as possible argon and reduce the nitrogen level. Figure 1 shows the vapor pressure of each compound in such column. The maximum level of argon has too much nitrogen. A compromise between argon and nitrogen level must be done.

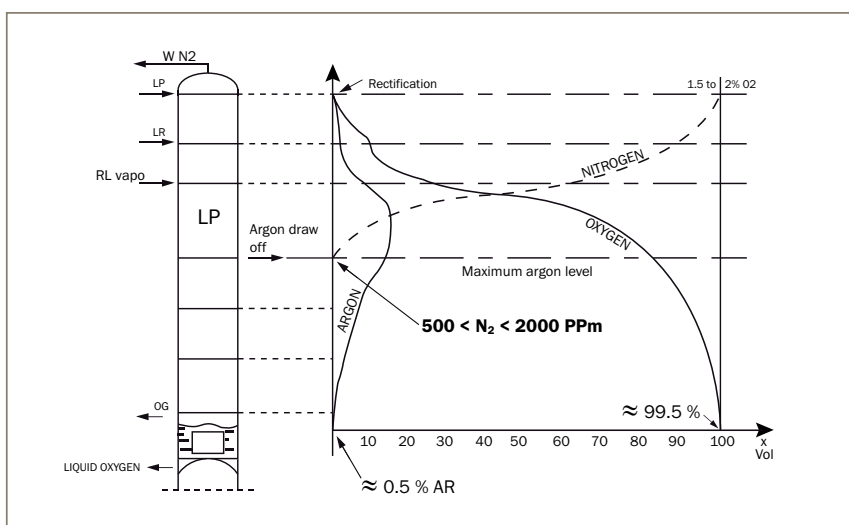

Figure 1

Most of the plants will then take argon at a point where it is safe to keep nitrogen level low. Nitrogen is lower, but argon as well. Oxygen is then relatively high in the crude argon column.

Typical analytical tools are the oxygen and argon measurement. Nitrogen can be approximated and you keep the introduction of nitrogen at minimal level.

Such analysis method gives a safe system, but not optimal argon production can be achieved.

WHAT CAN BE DONE ?

By using proper analytical tool to measure nitrogen level in the low pressure column, the plant can reach the maximum level of argon extraction with the acceptable nitrogen in the crude argon column. The LDetek's MultiDetek is the ideal tool to measure nitrogen in oxygen/argon mixture. By measuring continuously nitrogen in such mixture, optimal argon production can be achieved.

In some cases, increase of 5% argon can be achieved just by measuring nitrogen level accurately.

The MultiDetek can be interfaced with any acquisition system on ASU. Analog signal or digital signal can be provided. Ethernet connection is also available.

Such analyzer is easy to operate with its user friendly interface and can operate 24/24 to ensure extraction is well tuned up.

Such MultiDetek is using the PlasmaDetek technology with nitrogen selectivity. This avoids any oxygen trap consumable.



▲ MultiDetek



PlasmaDetek detector ▲

CONCLUSION:

The pay back of such analytical tool is fast. It will operate for many years and gives optimal efficiency of any argon production plant. The combination of MultiDetek platform with the PlasmaDetek technology is a reliable, efficient and accurate system that any plant is looking for.

APPLICATION NOTE

LD12-07



Analysis of Neon-Hydrogen-Argon-Krypton-Nitrogen with the PlasmaDetek & the HSR-Etek column

The analysis of Neon, Hydrogen, Argon, Krypton and Nitrogen by chromatography has always been problematic. The bad separation and the poor sensitivity for the analysis of these impurities are the reasons that make it complicated to realize. Even with the use of capillary columns, cryogenic system and/or hydrogen trapping system, the analysis of low ppb of these impurities cannot be performed in one run. Furthermore, the detectors available in the industry have some sensitivity limitation. It is then very difficult to measure low ppb for the mentioned impurities especially for Neon with the existing technologies.

LDetek has then developed a method for the analysis of Neon, Hydrogen, Argon, Krypton and Nitrogen. Using the PlasmaDetek system and the HSR-Etek column, the low ppb analysis without any interference can be successfully realized using a simple injection.

PLASMADETEK SYSTEM:

The PlasmaDetek can be configured in a non selective or in a selective mode depending of the lowest detection limit requested and the interference gases. Using its selective mode, the response ratio between the analyte of interest and the interference gases will be increased. The detector can then be very sensitive to the Neon, Hydrogen, Argon, Krypton and Nitrogen without being affected by background gases or interference gases.



Figure 1: PlasmaDetek detector



This is a stand-alone detector system that requires only helium or argon carrier gas to make the measurement. No need of doping gas or other devices. By using argon as carrier gas, the analysis of neon and argon cannot be realized.

CHROMATOGRAPHY CONFIGURATION:

This measurement is done by using a simple injection (see figure 2). The sample is injected through the HSR-Etek column and then goes directly to the PlasmaDetek inlet port. The carrier flow rate must be regulated at 30sccm and maintained stable. The column temperature must operate at 45Celsius until minute 4. The column temperature is then ramped up to 90Celsius at 10Celsius/minute. Using the temperature ramping mode, the analysis of Krypton and Nitrogen can be included in less than 16 minutes.

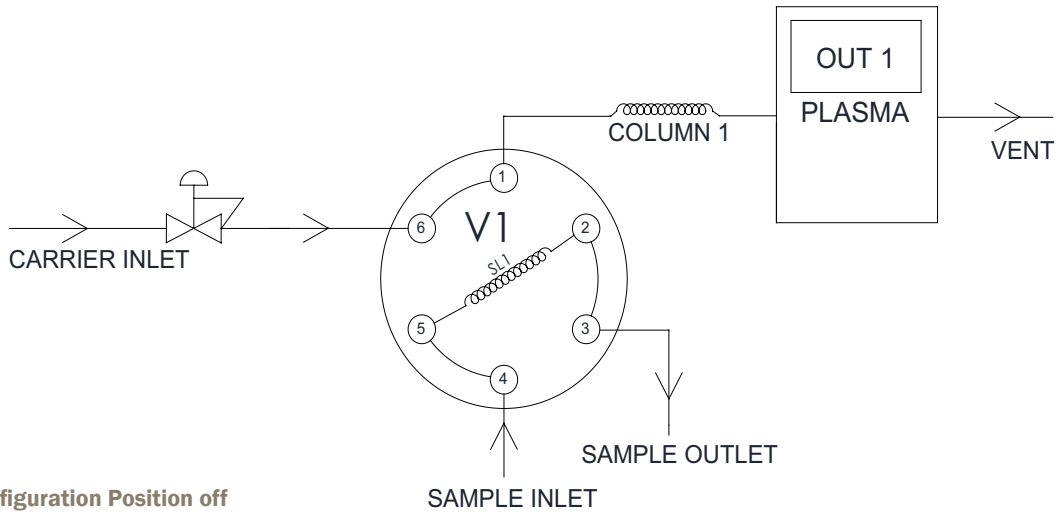

Figure 2: Configuration Position off

RESULTS AND PERFORMANCE:

Figure 3 shows the chromatogram obtained from this configuration.

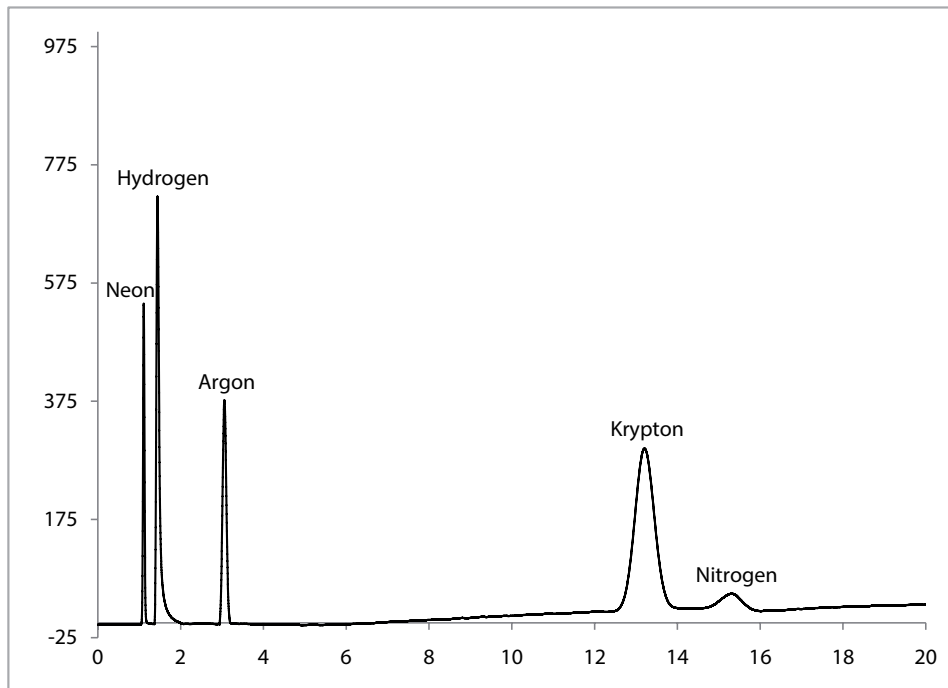

Figure 3: Mixture 4ppm Neon, 5ppm Hydrogen, 1ppm Argon, 4ppm Krypton, 0.5ppm Nitrogen in balance Helium

Figure 4 shows the performance of the system obtained with the configuration described above. The PlasmaDetek and HSR-Etek combination gives the possibility to achieve low ppb limit of detection with good resolution for Neon/Hydrogen, Argon/Oxygen and Krypton/Nitrogen using a simple injection. Higher concentration, up to %, can be also measured with the same system.

COMPONENT	CONCENTRATION	PEAK HEIGHT	NOISE	S/N	LOD (ppb) S/N = 3	LOQ (ppb) S/N = 5
Neon	4 ppm	562 mV	0.049 mV	11469	1.04	1.74
Hydrogen	5 ppm	756 mV	0.049 mV	15428	0.97	1.62
Argon	1 ppm	381 mV	0.049 mV	7775	0.39	0.64
Krypton	4 ppm	341 mV	0.049 mV	6959	1.72	2.87
Nitrogen	0.5 ppm	38 mV	0.022 mV	1727	0.86	1.45

Figure 4: LOQ and LOD calculation

PLASMADETEK SELECTIVITY:

Using its selectivity, the PlasmaDetek gives the advantage of being very sensitive to desired impurities only. See below an example of analysis of 2ppm Krypton and 4ppm Nitrogen in a balance of Oxygen using HSR-Etek column.

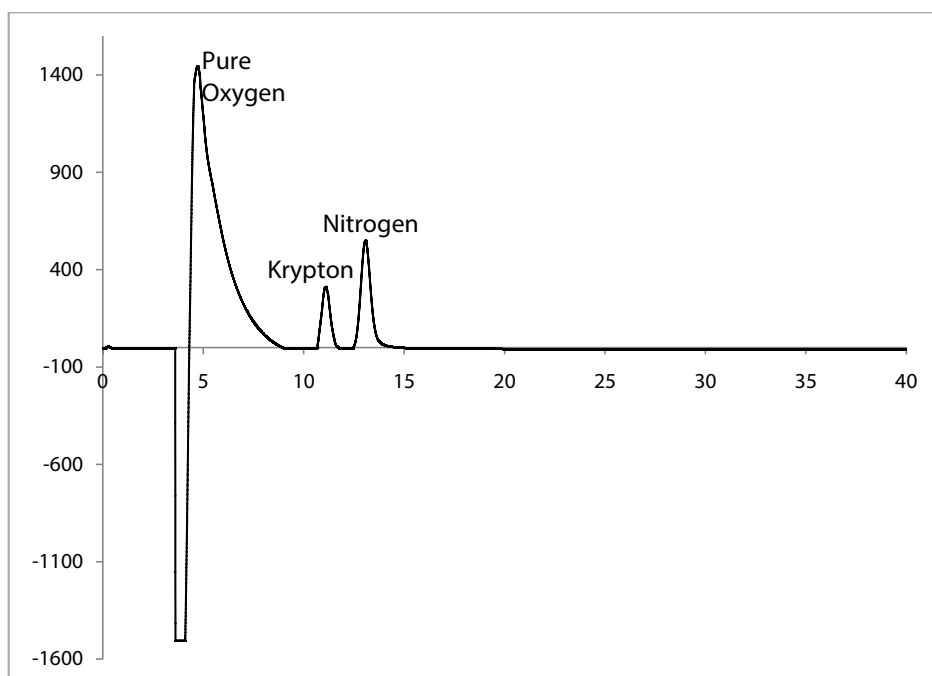

Figure 5: Mixture 2ppm Krypton, 4ppm Nitrogen in balance Oxygen

CONCLUSION:

Using the combination of the PlasmaDetek and the HSR-Etek column, the analysis of Neon, Hydrogen, Argon, Krypton and Nitrogen becomes an easy task. A simple injection through the HSR-Etek column and to the PlasmaDetek allow to measure ppb, ppm or percentage level of the mentioned compounds. This is a cost effective, maintenance free system and quick analysis technique avoiding consumables and regeneration procedures that will reduce complexity of the chromatography system.

APPLICATION NOTE

LD12-09



Hydrocarbons measurement for Oxygen production using PlasmaDetek & Multidetek-2



Oxygen is one of the basic chemical elements. In its most common form, oxygen is a colorless gas found in air. It is one of the life-sustaining elements on Earth and is needed by all animals. Oxygen is also used in many industrial, commercial, medical, and scientific applications. It is used in blast furnaces to make steel, and is an important component in the production of many synthetic chemicals, including ammonia, alcohols, and various plastics. Oxygen and acetylene are combusted together to provide the very high temperatures needed for welding and metal cutting.

The most common commercial method for producing oxygen is the separation of air using either a cryogenic distillation process or a vacuum swing adsorption process. Nitrogen and argon are also produced by separating them from air. The figure 1 represents a common cryogenic distillation process for producing oxygen.

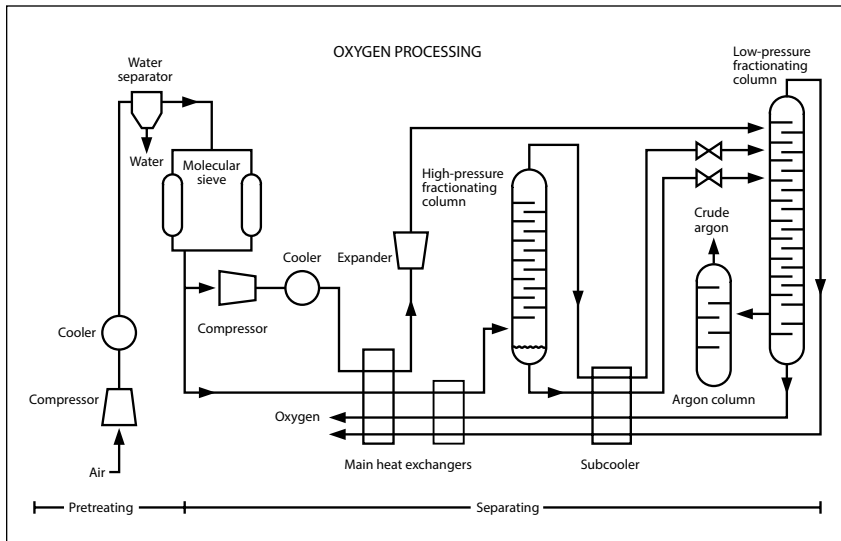

Figure 1: Diagram of a cryogenic distillation process

Because this process utilizes an extremely cold cryogenic section to separate the air, all impurities that might solidify—such as water vapor, carbon dioxide, and certain heavy hydrocarbons—must first be removed to prevent them from freezing and plugging the cryogenic piping what could result to an hazardous situation. The removal of hydrocarbons is also very important to avoid any problem in the subsequent air distillation that could lead to explosion.

Then, the operation of cryogenic distillation air separation units must be monitored by automatic analytical instruments. As a result, their output is consistent in quality and ensures safety of the site. Periodic sampling and analysis of the final product ensures that the standards of purity are being met. A good analytical instrument is then necessary to monitor the various sampling points of the air separation unit.

LDTEK SOLUTION:

With its integrated plasma technology, The LDetek's Multidetek-2 becomes the ideal tool to measure the purity of the oxygen. Its capability to monitor the hydrocarbons level from ppb level up to high ppm level using its plasma detector gives the ideal alternative to the standard use of a FID detector. With the use of the plasma for monitoring the hydrocarbons, there is no more need of using Fuel/Air mixture additionally to the carrier gas. The Multidetek-2 and its plasma only require argon carrier gas. It is then a big advantage since there is no handling and storage of hydrogen anymore on site. Moreover, the use of argon as carrier gas is also a great benefit because the argon is low cost and is already produced and available on any air separation plant.

The use of the Multidetek-2 for monitoring hydrocarbons level in oxygen production is also the ideal tool for a safety point of view. It is critical to have a reliable unit able to monitor 24/7 basis the level of hc's in oxygen on ASU. Being very sensitive to hydrocarbons, including C₂H₂ which is the most critical component, the Multidetek-2 becomes the best tool to use.

The Multidetek-2 unit can have multiple configurations to allow the measurement of different sampling points of the air separation unit. The monitoring of quality control at the end of oxygen production process can then be easily realized with a configuration allowing low ppb detection. This will ensure an accurate reading necessary for producing high quality grade oxygen. Using the same unit, a higher scale configured for high ppm measurement necessary to monitor the different sampling points of the crude material is also integrated in the unit.

An analysis example of hydrocarbons measurement in pure oxygen appears on the figure 2.

The Multidetek-2 can be interfaced with any acquisition system on ASU. Analog signal or digital signal can be provided. Ethernet connection is also available for remote control. Such analyzer is easy to operate with its user friendly interface and can operate 24/24 to ensure good oxygen production. For this application, such Multidetek-2 is using the PlasmaDetek technology with its hydrocarbons selective detector. This avoids any consumable.

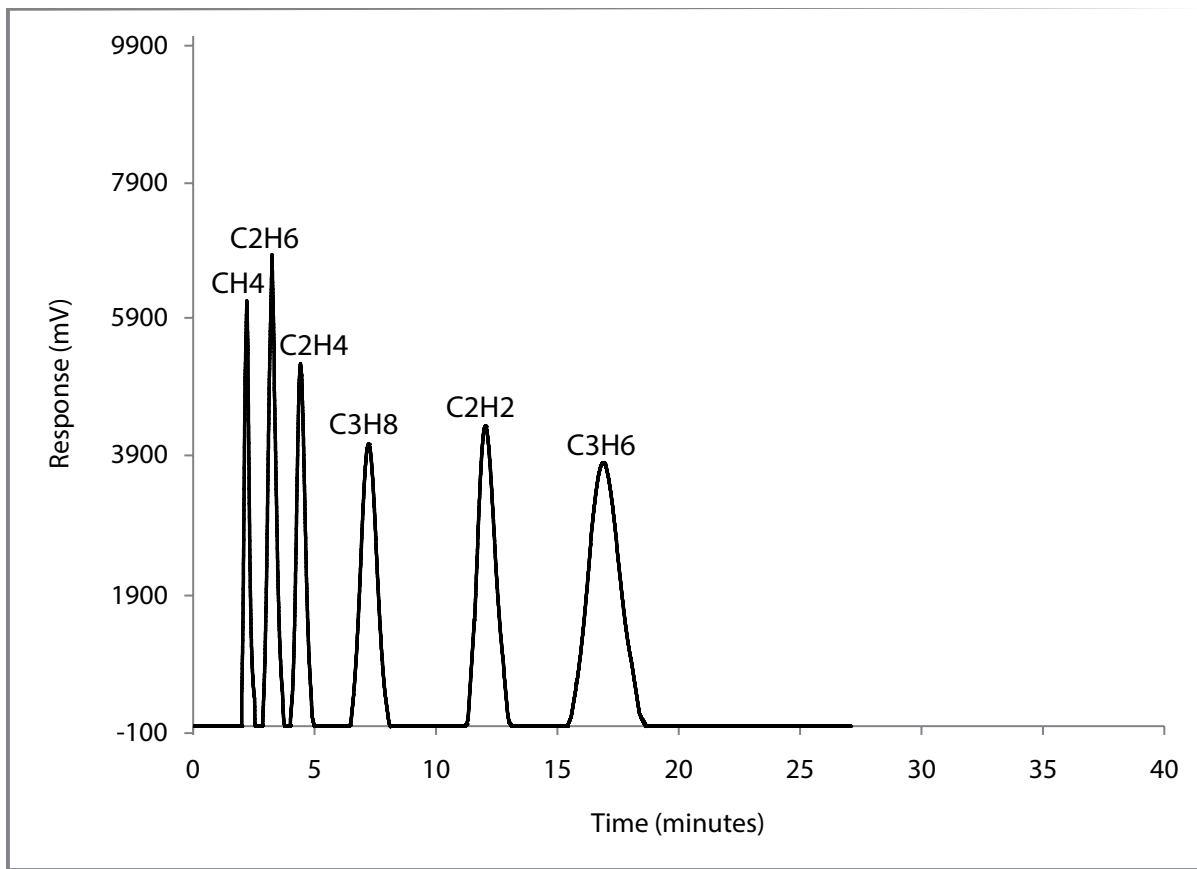

Figure 2: Chromatogram of hydrocarbons in pure oxygen using PlasmaDetek and Multidetek-2

MORE POSSIBILITIES:

A good return on investment can be also realized by configuring the same instrument for more components:

The analysis of CO₂ and any other permanent gases or sulfurs impurities can be added to the same instrument. Even more, the Multidetek-2 also offers the possibility to have multiple background gas configurations. The analysis of argon and nitrogen purity can then be added to the same unit.

One more time, with the simple use of argon as carrier gas and its integrated plasma, the Multidetek-2 can handle multiple measurements in multiple background gases.

CONCLUSION:

The pay back of such analytical tool is fast. It requires only argon as carrier gas which is available at low cost on any air separation plant. There is no more need of handling and storing hydrogen what is usually more expensive due to the need of safety sensors and procedures on site. The PlasmaDetek use in the Multidetek-2 is maintenance free and is a clean detector. It requires no cleaning procedure. The Multidetek-2 will operate for many years and gives optimal efficiency of any oxygen production plant.

The combination of Multidetek-2 platform with the PlasmaDetek technology is a reliable, efficient and accurate system that any plant is looking for.

APPLICATION NOTE

LD13-01



Analysis of UHP Hydrogen production using Plasmadetek-2 & compact GC Multidetek-2



◀ PlasmaDetek2



▲ MultiDetek2

The high purity hydrogen production demand is rising quickly and the need of measuring low ppb trace in a quick analysis run is then required. Most of the GC technologies available on the market use the same methods for years which required quite complex systems. Those systems require the use of different detectors to cover the application and a complex chromatograph configuration what make the price of such system increasing. The complexity of the chromatograph operations, the long analysis time and the limitations to achieve low ppb measurement are often faced.

LDETEK SOLUTION:

With its integrated plasma technology, The MultiDetek-2 from LDetek becomes the ideal tool to measure the hydrogen purity. Its capability to monitor the permanent gases and hydrocarbons from ppb level up to high ppm level using only one plasma detector gives the ideal solution. In comparison to the existing method, the PlasmaDetek-2 gives the advantage of being selective to the desired impurities and then block the interference coming from the matrix gas. In the case of UHP hydrogen production, measuring low ppb traces of O₂ and N₂ is complex since their elution time is very close to the hydrogen matrix.

Then, to allow the analysis of O₂ and N₂, relatively long molecular sieve columns are required in combination with multiple valves for flushing out the hydrogen gas. In some cases, a hydrogen trapping module may be necessary. It then increases the cost of the system and extends the analysis time. Peaks shape can be also affected with the use of longer columns.

With the PlasmaDetek-2, a simple system having one valve and one Molecular Sieve column is required. The detector is configured with two sensors to measure O₂ and N₂ respectively in selective mode. Refer to Figure 1 for the configuration drawing. Going this way, the analysis time can be reduced, the sensitivity increased and it gives an easy to use system with no consumable or maintenance required.

An analysis example of impurities O₂ & N₂ in a hydrogen sample, using a standard ionization detector in combination with the same configuration that appears on Figure 1, has been used to generate the chromatogram that appears on Figure 2. We can clearly see the interference of the hydrogen over the traces O₂ and N₂. The hydrogen matrix interference overlapping the traces O₂-N₂ will be amplified when going lower at low ppb level and it will become not possible to measure the impurities without using other techniques requiring more long columns, additional valves and H₂ trap.

At the opposite, on Figure 3 appears a chromatogram of traces O₂ and N₂ with the use of the PlasmaDetek-2 using its selective mode. It is clearly demonstrated that the selectivity gives an important benefit that makes such type of analysis possible with a simplified chromatography method demonstrated on Figure 1.

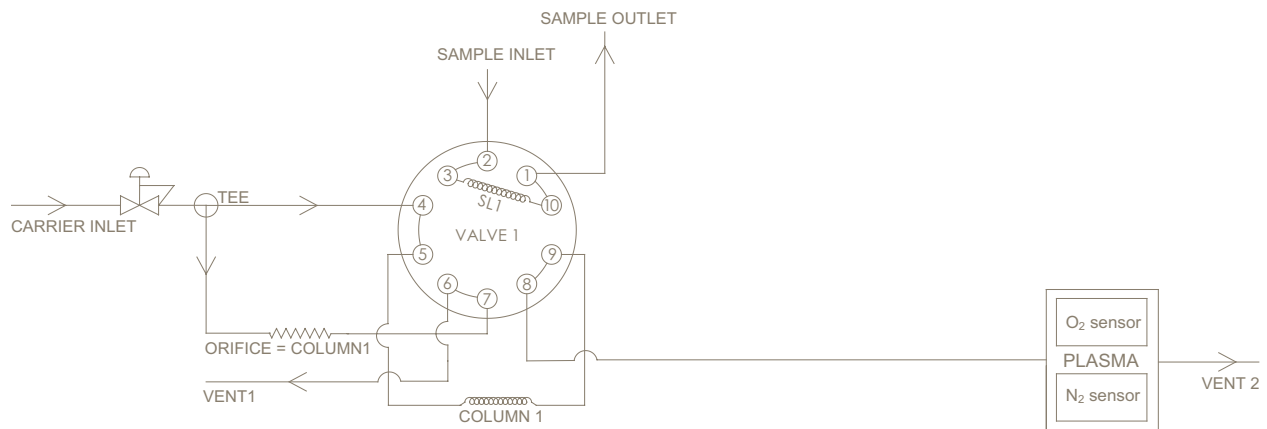

Figure 1: Configuration used for measuring traces O₂ - N₂ in matrix hydrogen. (One additional non selective sensor can be added to the same plasma for measuring traces CH₄ - CO with the same channel.)

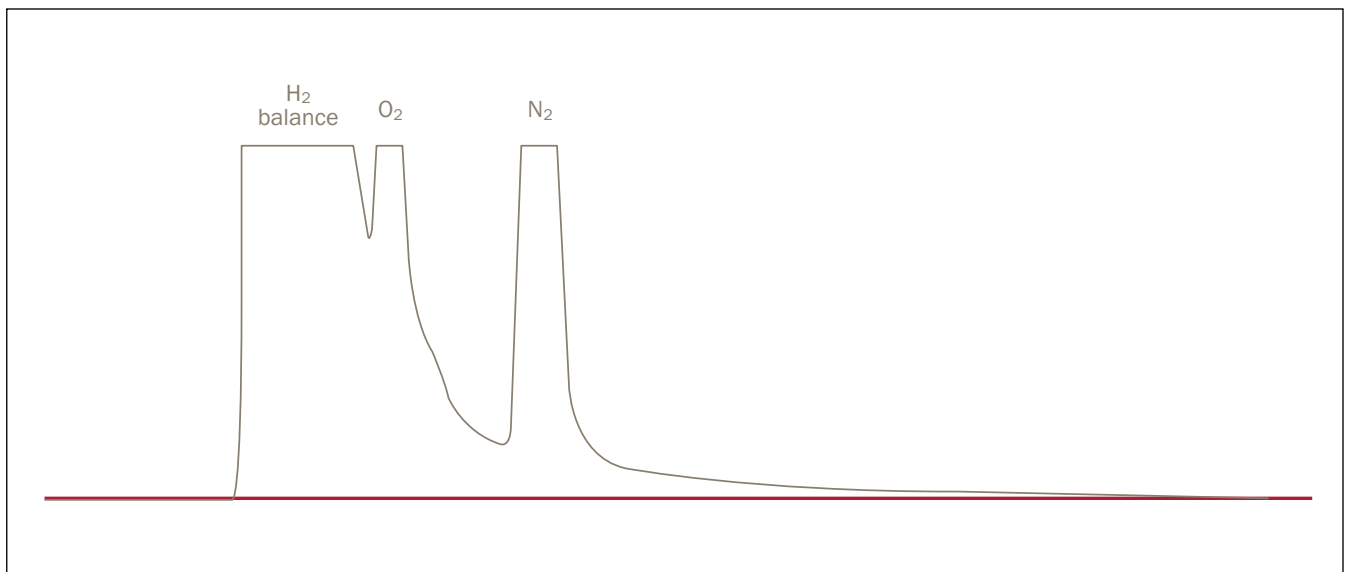

Figure 2: Chromatogram of traces O₂ - N₂ in a hydrogen matrix using a conventional non selective ionization detector.

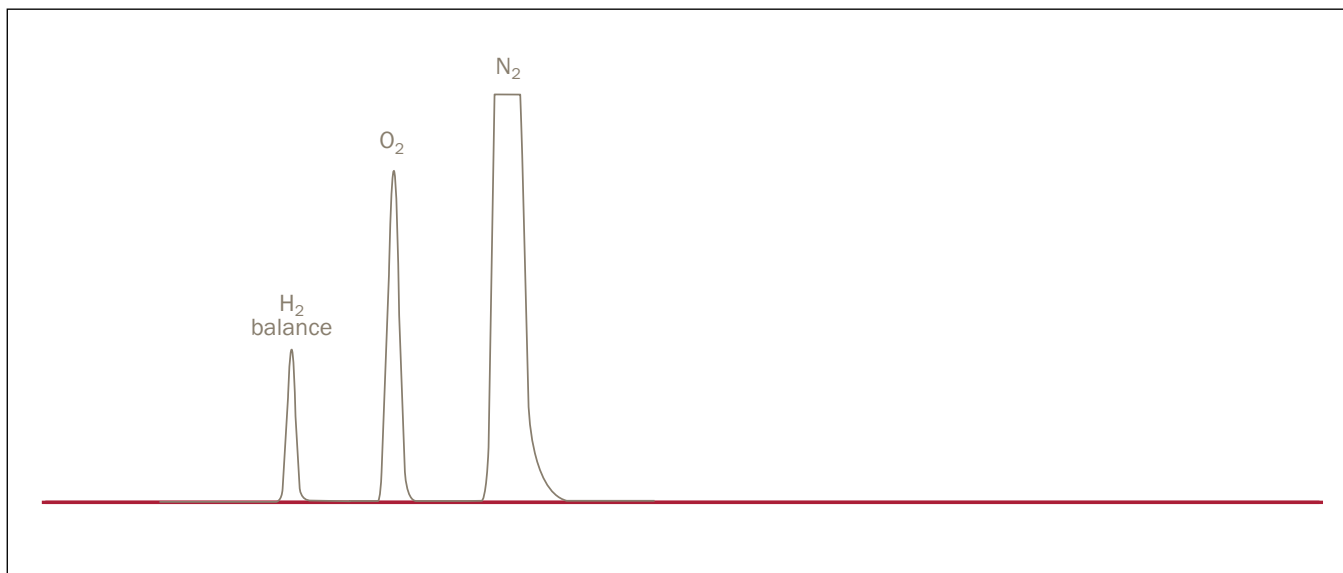

Figure 3: Chromatogram of traces O_2 - N_2 in a hydrogen matrix using PlasmaDetek-2 in a selective mode.

ARGON AS CARRIER GAS:

Since the PlasmaDetek-2 can be used with argon as carrier gas, you get some more advantages over conventional ionization detector.

Operation cost of the system is reduced compared to system that requires helium. With the helium shortage worldwide and its price increasing constantly, the use of argon becomes the best alternative to keep same sensitivity level.

Furthermore, in the case when argon as impurity is not required, the use of argon as carrier gas simplifies the chromatography. With conventional ionization detector using helium, the Ar will interfere with O_2 measurement. If Ar measurement is needed, the PlasmaDetek-2 can also be used and configured accordingly to get Ar and O_2 separately (see application note LD12-3).

COMPLETE SOLUTION:

Using the PlasmaDetek-2 as detector and the MultiDetek-2 as compact GC platform, the same instrument can be used to measure additional components in hydrogen matrix.

The analysis of traces Ar-Ne-CH₄-CO-CO₂ and hydrocarbons can be added to the same instrument just by configuring additional channels to the compact GC MultiDetek-2. Some other sensors can be added to the same plasma for the added impurities. No needs of additional detectors like FID or consumables are required.

CONCLUSION:

The pay back of such analytical tool is fast. It requires only argon as carrier gas which is available at low cost on any air separation plant. The PlasmaDetek-2 used in the MultiDetek-2 is maintenance free and is a clean detector. It requires no cleaning procedure. The compact GC MultiDetek-2 will operate for many years and gives optimal efficiency of any hydrogen production plant.

The combination of MultiDetek-2 compact GC with the PlasmaDetek-2 technology is a reliable, efficient and accurate system that any plant is looking for.

APPLICATION NOTE

LD13-02



Measurement of nitrogen in a mixture of Argon/Oxygen (crude argon) online with the LD8000-Crude



▲ LD8000

The measurement online of nitrogen in UHP argon is widely used and the LD8000 is now a reference in such measurement. However when measuring crude argon with a few % of oxygen, the conventional online instruments are not suitable anymore. Such crude liquid argon (also called CLAR) needs to be analyzed in many cases to be sure the level of nitrogen is within the specification either as a final product for steelmaking or welding applications or before being purified to produce UHP argon. Good analytical tool is then required to have a good process control. The use of Gas Chromatograph (GC) has been widely used to measure this nitrogen level. Even if GC is giving good and accurate results, the analysis time is quite long. In many cases the response time is too long to take proper action if the nitrogen goes too high in concentration. A few minutes are required to get the analysis results and this delay can bring a lot of problems to the plant if it increases suddenly.

The need of having an online instrument with a few second response time has been desired for a long time. The LD8000-Crude can now achieve this task and give a better process control for any plant or application that needs to measure N₂ in the Crude Argon having up to 5% oxygen.

DESIGN:

The LD8000-Crude is still using the unique PlasmaDetek technology, but incorporated in a special design, it makes possible to have this plasma emission detector (PED) working with up to 5% oxygen. Common PED cannot create a stable plasma with oxygen. The interference and instability of the plasma is a big challenge. But LDetek has developed a method and a design to have such argon micro-plasma being able to measure from ppb to % of nitrogen with up to 5% oxygen.

A specific algorithm has been developed and implemented in the microcontroller unit giving a linear and accurate measurement of nitrogen.

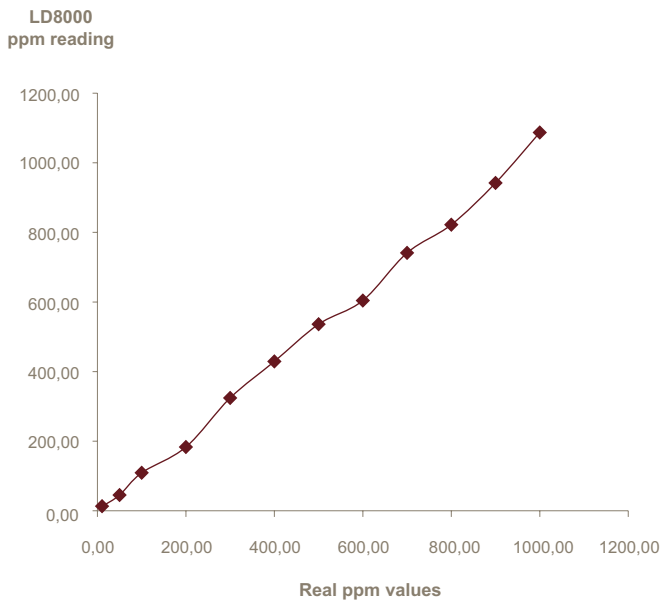

Figure 1 : LD8000 Crude linearity 0-1000 ppm

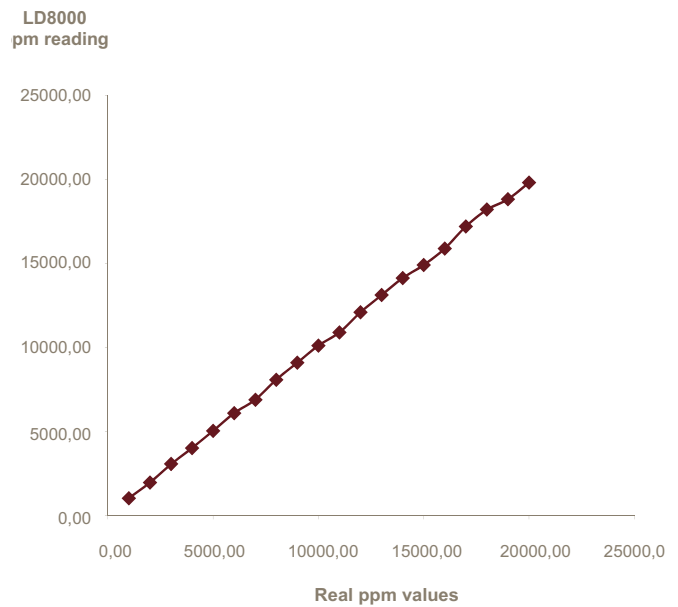

Figure 2 : LD8000 Crude linearity 0-20000 ppm

With the 3U cabinet, this instrument can fit in any rackmount cabinet or plant installation. No need of carrier gas and external consumable parts like purifier or oxygen scrubber. Only sample is needed to provide this quick measurement.

The micro controller unit inside combined with the LCD display provide a user friendly interface easy to operate. But it also gives all features that such instrument needs on a plant (dry contact relay for range ID, status contact for error monitoring, 4-20 mA output for value reading, auto-resolve alarms system, etc).

RESPONSE TIME:

The response time for such application is critical. The use of a gas chromatograph has been widely used and it gives good results, however the analysis time can be as high as 5-6 minutes. It is very important, in most of such applications, to have a quick response time to act quickly on the process when the level of nitrogen goes too high.

Using the LD8000-Crude, you get a response time of a few seconds ($T_{90} < 20$ sec) with a measurement of a few ppm. With the 4-20mA output signal, the process plant can track the level of nitrogen continuously. If serial communication is required, this instrument can send and be controlled by such communication port.

HIGHER OXYGEN CONTENT:

For measurement of N₂ in Crude Argon containing more than 5% Oxygen level, the LD8000-Crude instrument can be configured to achieve such task. The unique plasma detection system (PED) for Crude Argon measurement stays the same. An additional module for sample gas treatment is added to the instrument, which makes the detection of N₂ in Crude Argon having more than 5% Oxygen possible.

For more information and details, do not hesitate to contact LDetek.

APPLICATION NOTE

LD14-01



Light hydrocarbons measurement with the *PlasmaDetek-E system with nitrogen carrier gas and the MultiDetek-2.

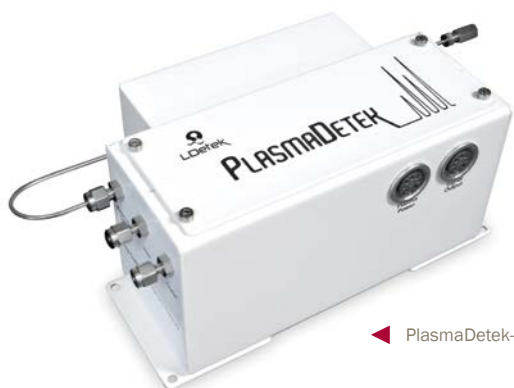

◀ PlasmaDetek-E



MultiDetek-2 ▲

Hydrocarbons are ones of the most important impurities measured in the industry. Whether it is for safety, quality control, special gases or any other needs, those compounds are everywhere.

The techniques used to measure those compounds have been the same for quite some years. The FID (Flame Ionization Detector) is surely the most widely used in the industry. The selectivity for hydrocarbon (HC) gives the simplicity desired for all gas chromatograph (GC) users. However the need of air, but mostly hydrogen as fuel is the drawback of this technology. Many plants and laboratories would like to get rid of the hydrogen as potential explosive gas. All the safety feature (valves, extra lines, procedures, etc) are required and brings extra cost and manpower.

Other technologies to measure the light hydrocarbon have arisen over the years. The Discharge Ionization Detector (DID) brought a solution without the need of air and fuel. Working on helium carrier gas, the safety problem was resolved. However the selectivity is not present and the need of helium is required. With the worldwide shortage of helium and its increasing price constantly, it becomes a more costly solution not attractive enough for gas chromatograph developer.

Another solution was brought to the market: the Plasma Emission Detector (PED). With its advantage to work in helium and argon carrier gas, this solution becomes more attractive because of argon pricing. It is also produced and available anywhere in the world. Furthermore, the PED has some selectivity against some other gases, not completely, but enough to make the GC user life easier. However, there is no selectivity for HC against many compounds, including air and oxygen. Measuring HC in a stream of Oxygen or Air is very important in Air Separation Unit (ASU). There is also a lack of sensitivity in some case by using argon as carrier. Measuring C₂H₂ for a ASU plant is critical and it needs to be measured in low concentration.

LDETEK SOLUTION:

With the patent pending PED system (PlasmaDetek-E) provided by LDetek, it is now possible to improve and overcome the drawbacks of other available technologies.

NITROGEN CARRIER GAS:

First of all, such system can work with argon and helium, but with nitrogen carrier as well. Nitrogen is a low cost and inert gas that makes it very attractive to use in a GC. Air contamination and leak are not much problematic as it is with other PED systems. Typical PED detector can be sensitive, but it needs to be in a very pure environment. A little leak or contamination can compromise the whole measurement. The recovery time from column changes and GC start-up is then extremely fast with the PlasmaDetek-E using nitrogen as carrier gas.

A simple injection configuration has been used to inject different matrices to evaluate the response and selectivity over CnHm components. Figure 1 shows such configuration with the PlasmaDetek-E system.

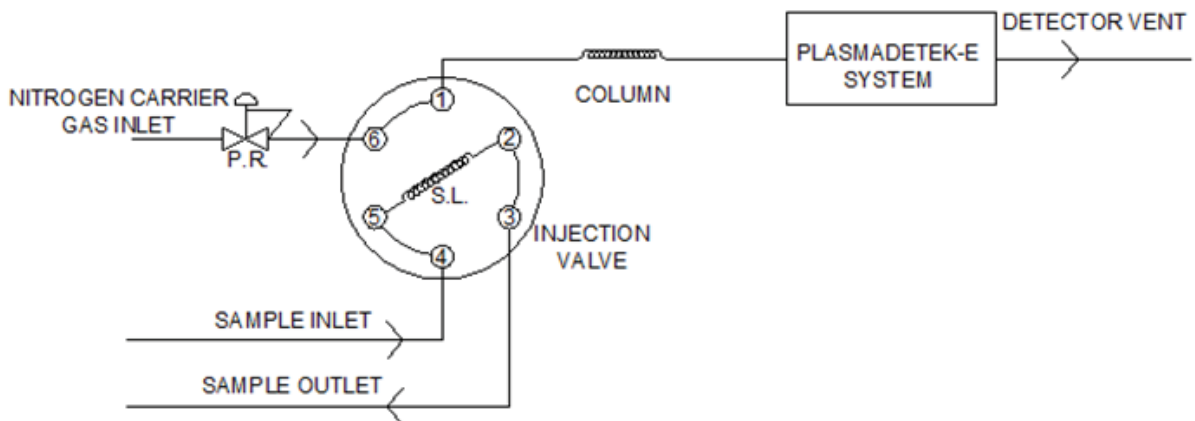

Figure 1

SENSITIVITY:

To evaluate the response and sensitivity, injection of CnHm impurities in Argon balance has been used. Figure 2 shows the chromatogram with indication of each compounds detected by the PlasmaDetek-E.

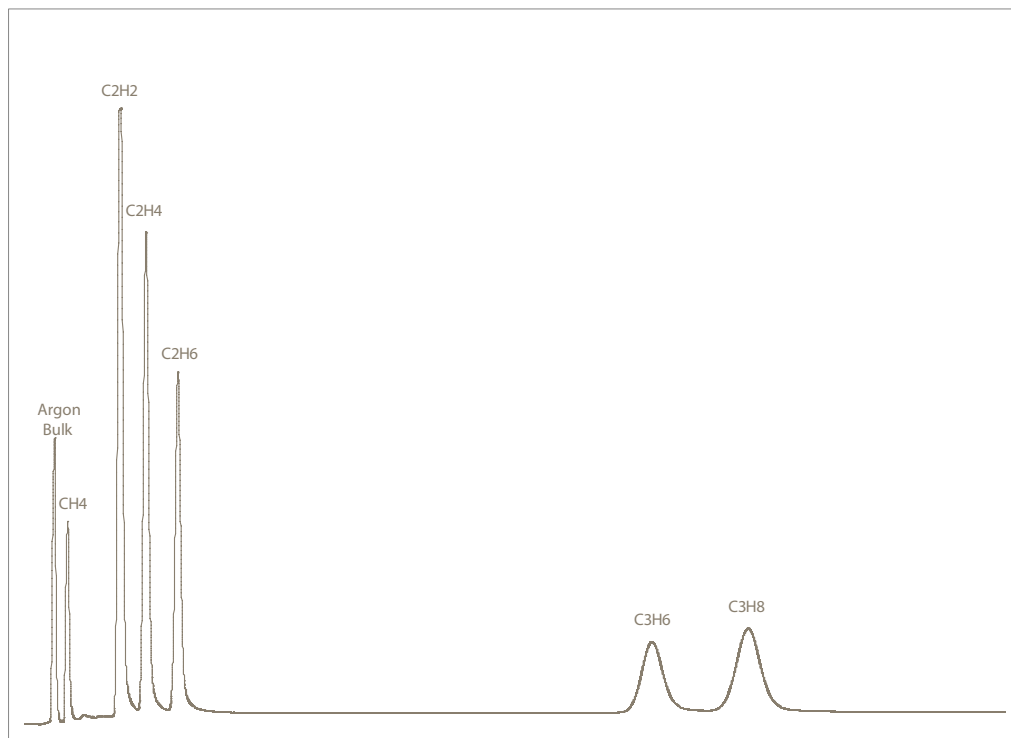

Figure 2

By evaluating the noise level and peak height, LDL for each compounds can be evaluated by considering the limit as 3 times the noise level. Figure 3 is showing the results of this analysis.

COMPONENT	CONCENTRATION	PEAK HEIGHT	NOISE	LDL (3X NOISE)
CH4	9.56 ppm	1300 mV	1.5 mV	11 ppb
C2H2	10.50 ppm	4800 mV	1.5 mV	3 ppb
C2H4	9.96 ppm	3100 mV	1.5 mV	4 ppb
C2H6	10.80 ppm	2300 mV	1.5 mV	7 ppb
C3H6	10.40 ppm	460 mV	1.5 mV	33 ppb
C3H8	9.20 ppm	560 mV	1.5 mV	24 ppb

Note: other LDL could be obtained with different injection volume and chromatographic conditions

Figure 3

By using different injection volume and/or chromatographic configuration, even lower LDL could be obtained. However, by comparing with same the chromatographic condition than a traditional argon PED, LDL is improved by a factor of about 10 times with the PlasmaDetek-E. It is even more the case for C2H2, where it is about 100 times more sensitive.

SELECTIVITY:

By using the same configuration as figure 1, air has been injected to evaluate the interference that can occur with the first hydrocarbon content out of the column, which is CH4. Figure 4 shows an injection with the PlasmaDetek-E using argon as carrier gas optimized for the best response to Hydrocarbon in air. It is obvious that the CH4 is influenced by the residual air. In such cases, extra valves or hardware would be required to achieve possible measurement.

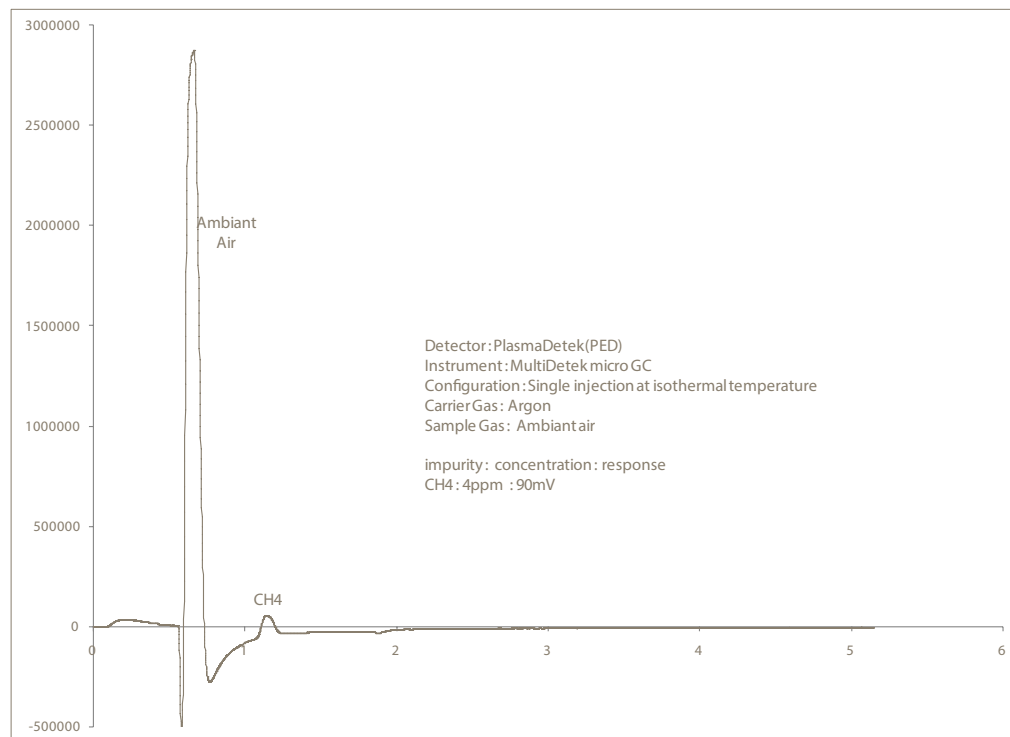

Figure 4

Figure 5 is using the same system with nitrogen carrier gas. Air response has been reduced considerably compared to argon carrier gas. Only with a simple injection configuration will make the CH₄ detectable.

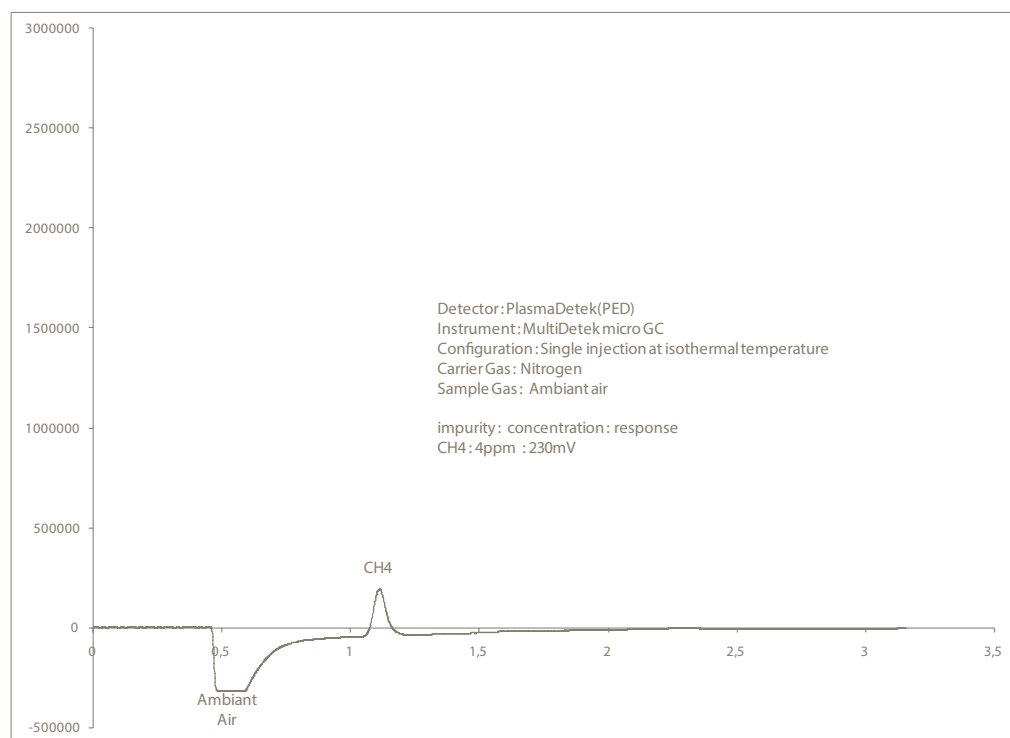

Figure 5

CONCLUSION:

With the PlasmaDetek-E system, lights hydrocarbon measurement is now safe and easy. No fuel, no air and no safety features needed, only nitrogen carrier gas.

It is also the lowest operation cost solution, but the sensitivity is not compromised where low ppb can be achieved.

APPLICATION NOTE

LD15-08



Measurement of impurities in UHP helium using MultiDetek2 and PlasmaDetek2



▲ MultiDetek2

▲ PlasmaDetek2

Helium is a widely used gas in different needs such as cryogenics, pressurizing and purging, welding, controlled atmospheres, leak detection and breathing mixtures. Having a good analytical tool is mandatory to ensure the required purity of helium.

The most popular technique for UHP helium analysis is to detect impurities by gas chromatography. But some detection technologies within the GC do not provide the desired detection limit or can simply not measure some critical impurities like neon.

LDETEK SOLUTION:

The MultiDetek2 combined with the PlasmaDetek2 detector provides an ideal solution to measure the different impurities in UHP helium. With the PlasmaDetek2, based on plasma emission detection, impurities in low ppb can be detected, even neon. The discharge ionisation detector (DID) can simply not detect neon or require a different operation mode to achieve ppm measurement. Which is not enough for many helium producers where they need lower detection limit in ppb. The operation is also more complex since the ionisation voltage needs to be changed when neon has to be detected.

LDetek solution gives an easy system to use with very good sensitivity. Figure 1 shows such configuration.

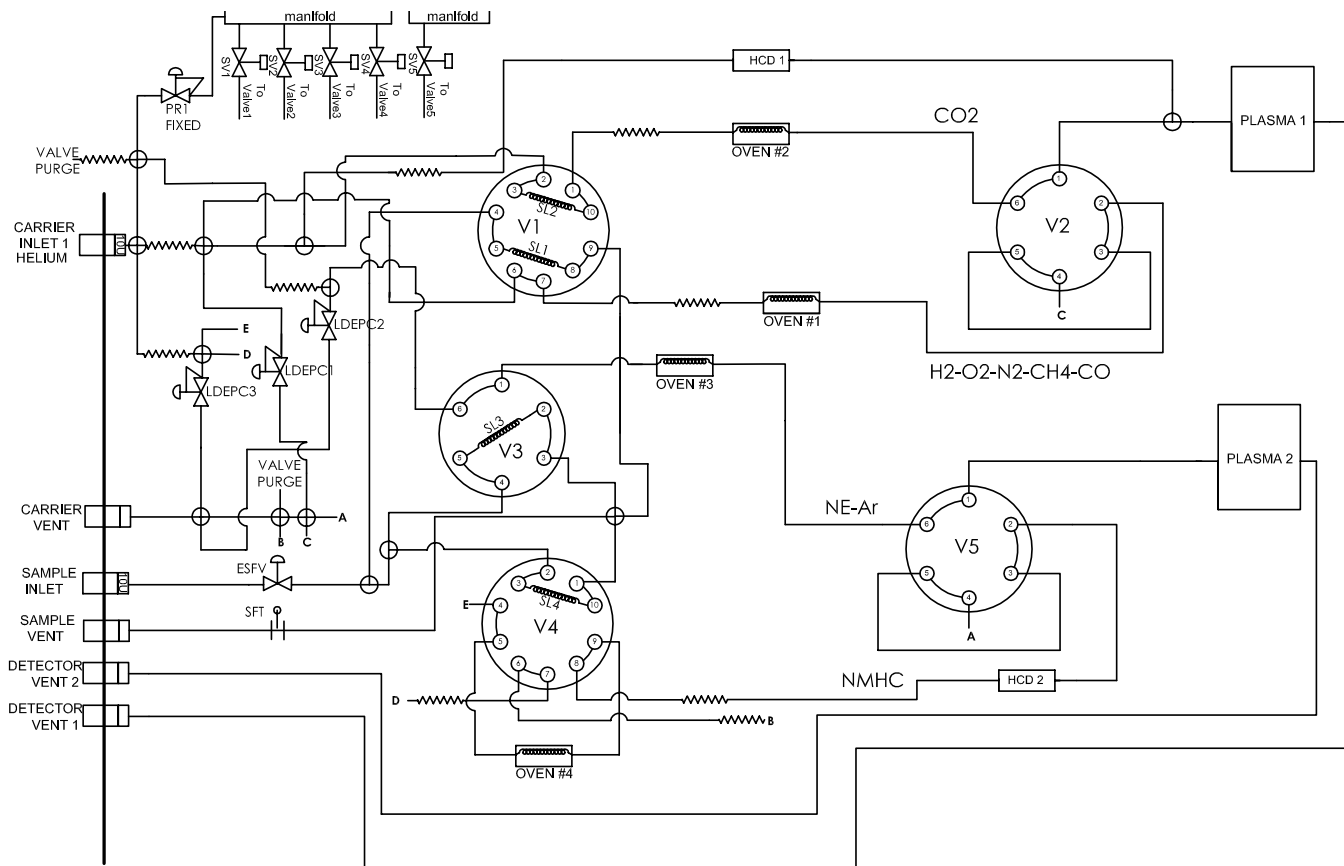

Figure 1

Two plasma cells are used to reduce the number of selection valves. Simultaneous injection in both plasmas is possible to accelerate analysis time. The parallel analysis feature within the MultiDetek2 software can be enabled to give the opportunity to acquire two chromatograms at the same time.

Neon and argon are measured within the same channel using the argotek column from LDetek. Such column gives a true argon peak by separating O2 and argon completely. Be sure to check application note LD12-3 on our website for more details. It also makes possible the measurement of neon against H2.

When using the PlasmaDetek2 technology, different optical filters are used to ensure true measurement of the components when interference can occur. For example, O2 is measured accurately against argon by using a specific optical filter giving a signal specifically to O2 and not argon.

Figure 2 shows a chromatogram of such system with a standard gas.

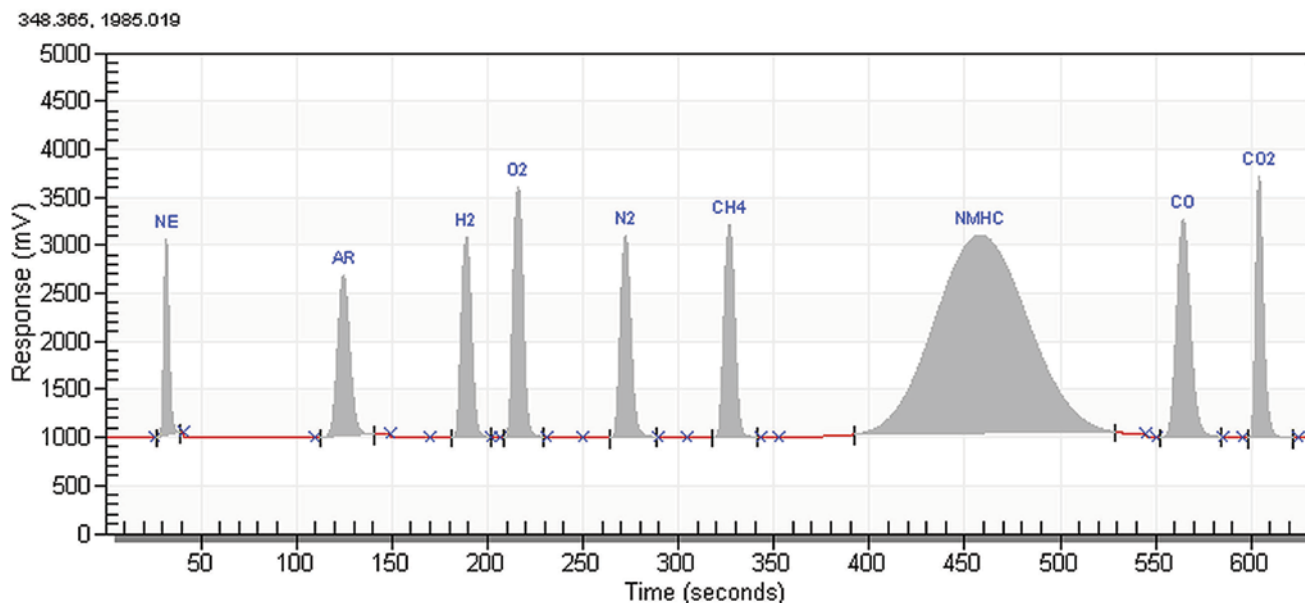

Figure 2

Based on noise to ratio, LDL is calculated as follows:

COMPONENT	CONCENTRATION	PEAK HEIGHT	NOISE	LDL (3X NOISE)
Ne	4.8 ppm	3010 mV	2 mV	0.009 ppm
Ar	4.1 ppm	2720 mV	2 mV	0.009 ppm
H ₂	5.5 ppm	3120 mV	2 mV	0.011 ppm
O ₂	6.2 ppm	3552 mV	2 mV	0.010 ppm
N ₂	5.4 ppm	3099 mV	2 mV	0.010 ppm
CH ₄	5.5 ppm	3254 mV	2 mV	0.010 ppm
NMHC	4.6 ppm	3101 mV	3 mV	0.007 ppm
CO	5.4 ppm	3331 mV	2 mV	0.013 ppm

Note: other LDL could be obtained with different injection volume and chromatographic conditions

COMPLETE SOLUTION:

Our Helium purity analysis offers a complete cabinet solution including the MultiDetek2 compact GC system, the LDGSS ultra high purity remote stream selector system, the LDP1000 carrier gas purifier and the moisture analysis instrument all integrated in one cabinet. The stream selector can be manually controlled using the front switch or can be remotely controlled with the MultiDetek2. A pre programmed sequence can also be done with LDGSS. The moisture analysis is re-directed to the MultiDetek2 analog input. This way, all data can be managed by MultiDetek2 using one channel communication protocol. The system is pre-configured and certified by experts at LDetek facility before shipping.



CONCLUSION:

Using both the PlasmaDetek2 and the MultiDetek2, only one system can measure all permanent gases with the sensitivity required. No need of additional oxygen analyzer or other setup for neon measurement. Furthermore, with the LDetek technology this maintenance free system avoids any trap or scrubber for the argon impurity.

APPLICATION NOTE

LD16-02



Analysis of hydrocarbons, CO₂, N₂O in Oxygen with the MultiDetek2 compact GC system using Nitrogen as carrier gas and the PlasmaDetek-E detection technology



▲ MultiDetek2

▲ PlasmaDetek2

LDETEK SOLUTION:

The hydrocarbon analysis for the production of high purity Oxygen on air separation plants is essential for safety of the operations and quality of the product. For a very long time, the flame ionisation detector has been used for detection of trace hydrocarbons in different gas mixtures. This detector has now many different designs all based on carbon ions collection. The FIDs require a mixture of Air and Hydrogen to generate the flame used for ionisation. It is also necessary to have extra safety based on Hydrogen gas handling. All these points result in increase of operating and start-up costs as demonstrated in Figure 1.

LDetek has developed a detection system based on plasma emission detector (PlasmaDetek E) for the analysis of trace hydrocarbons in different gas mixtures. This PED technology offers enhanced sensitivity and selectivity to hydrocarbons using Nitrogen as single discharge/carrier gas. Other emission and ionisation detection technologies are known in the market for the analysis of hydrocarbons using Argon or Helium as discharge/carrier gas. However, these systems don't offer the selectivity and sensitivity to allow running a single injection through a column without having interferences from residual Oxygen. Other techniques offering NMHC detection are also available and are sufficient in certain cases. Nevertheless, the NMHC detection doesn't give the ability to focus on the measurement of critical impurities like low concentration acetylene in Oxygen production. Using the MultiDetek2 combined with the PlasmaDetek E with Nitrogen carrier gas, the system can be customized for the range and LDL that are specifically required for each impurity. This way, it is possible to configure the system according to each air separation plant specification. As shown in figures 2 and 3, low detection is possible using Nitrogen as carrier gas with PED technology. No need of complex valve and column chromatography configuration for flushing out the background gases.

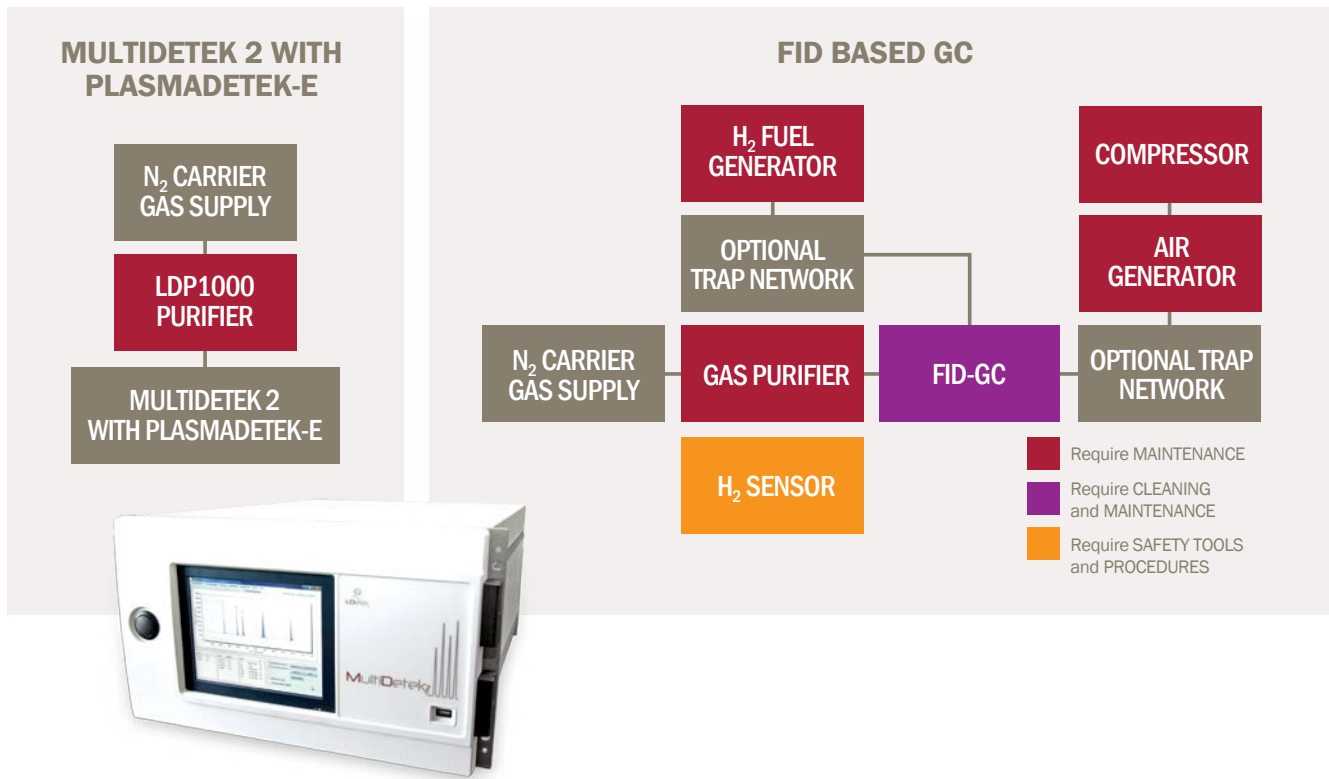

Figure 1 : Comparison between FID based GC and MultiDetek2 compact GC with PlasmaDetek-E

RESULTS:

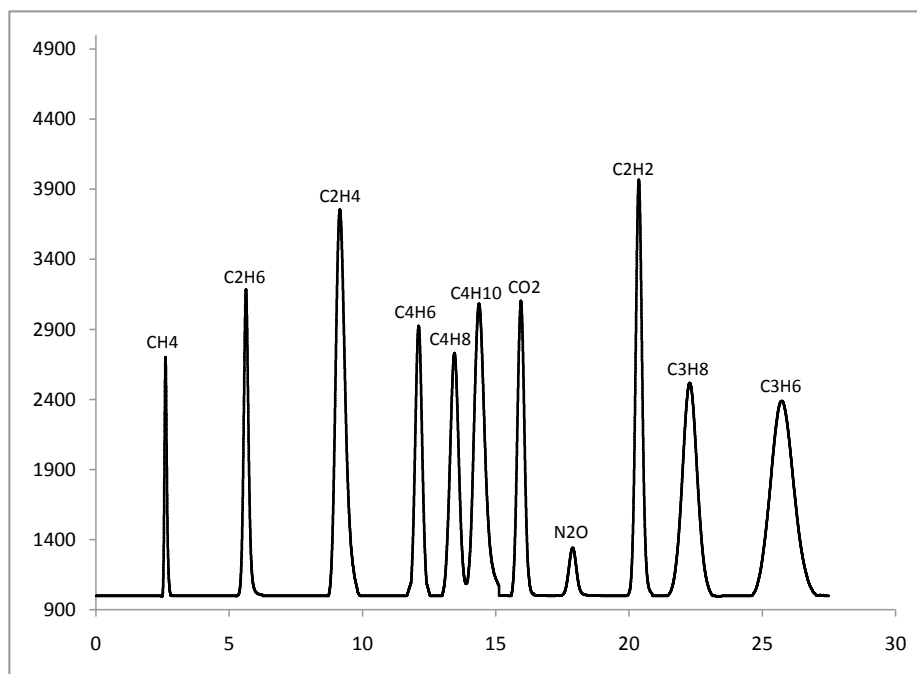

Figure 2 : Chromatogram of trace impurities in balance Oxygen

COMPONENT	CONCENTRATION	PEAK HEIGHT	NOISE	LDL (3X NOISE)
CH4	18.1 ppm	2760 mV	2.1 mV	0.041 ppm
C2H6	8.6 ppm	3308 mV	4.0 mV	0.031 ppm
C2H4	8.2 ppm	3888 mV	4.3 mV	0.027 ppm
C4H6	2.1 ppm	2969 mV	11.0 mV	0.023 ppm
C4H8	1.8 ppm	2798 mV	11.8 mV	0.023 ppm
C4H10	2.1 ppm	3190 mV	11.5 mV	0.023 ppm
CO2	4.1 ppm	3199 mV	11.0 mV	0.042 ppm
N2O	0.8 ppm	1401 mV	3.0 mV	0.005 ppm
C2H2	1.1 ppm	4098 mV	10.5 mV	0.007 ppm
C3H8	8.9 ppm	2559 mV	4.1 mV	0.043 ppm
C3H6	8.7 ppm	2501 mV	3.9 mV	0.041 ppm

Note: other LDL could be obtained with different injection volume and chromatographic conditions

CONCLUSION:

With Nitrogen gas used as carrier, the MultiDetek2 with Plasmadetek-E becomes the ideal gas measuring instrument for trace detection of hydrocarbons on the air separation plants for high purity Oxygen monitoring. Keeping the start-up and operating costs low and offering enhanced hydrocarbon detection, LDetek is proud to offer its robust and easy to operate system.

APPLICATION NOTE

LD16-06



LD8000 MultiGas online gas analysis solution for high purity compressed Helium used in cryogenic installations.



▲ LD8000 MultiGas

▲ PlasmaDetek2

Cryogenics is the branch of physics that deals with the production and effects of very low temperatures. Helium was a natural choice of coolant as its properties allow components to be kept cool over long distances. Super fluid helium has remarkable properties, including very high thermal conductivity; it is an efficient heat conductor. These qualities make helium an excellent refrigerant for cooling and stabilising the LHC's large-scale superconducting systems. The Large Hadron Collider (LHC) at institutions like the CERN in Switzerland is the largest cryogenic system in the world and one of the coldest places on Earth. It is one of the examples where the use of cryogenic Helium is essential for good working of the system.

The difference from conventional industries is that repairing a cryogenic system and reaching the process nominal conditions is a time-consuming action due to the thermodynamic constraints. For this reason, fault diagnostic functions, capable to detect and identify faults before their degeneration into failures, become more and more important. In cryogenic installations, the most critical class of equipment consists of rotating machinery, such as pump, turbines and compressors. Beside the problems related to failures of compressors, turbines, etc... The limitation of plant runtime and failures are also due to impurity loads to the cold box. Mostly smaller sources of water and air contamination are found just before the beginning of appearance of the Breox oil in the vacuum screw compressors that leads to a high load of the cold box with water, formaldehyde and other organic components. This fault situation must absolutely be detected at the beginning to minimize the impact of failure.

This is why it is required to have an impurity monitoring instrument for the cold box feed gas that measures the ratios of air, water, hydrocarbons and oil in the gas running from the recycle compressor to the cold box. This way, the maintenance and actions can be taken at the right moment. The analytical instrument must monitor trace N₂-O₂-water and hydrocarbons in high purity Helium.

3.0 APPLICATION NOTES

LDETEK SOLUTION:

LDetek offers its online LD8000 MultiGas based on plasma emission technology (PlasmaDetek2) to trace the O₂-N₂-CnHM and water impurities in cryogenic Helium. Using a single detection technique based on plasma emission, the trace impurities can be measured with an online mode. The required range for this type of application is usually 0-100ppm for O₂ and N₂, 0-25ppm for moisture and 0-10ppm for CnHM. Other ranges can be configured on request. The system monitors in continue the Helium purity without the use of Chromatography columns. The response analysis time for each gas can be done within 30 seconds. Better response time can be achieved depending on the purge flow rate that is adjustable on the LD8000. Since the Helium cost is an important factor, LDetek has designed its unit to ensure low sample flow consumption and this with consideration to ensure keeping a quick response time.

On top of that, the design is based on independent micro plasmas to ensure the protection of the system from oil contamination on long-term operation. A first plasma is isolated for measuring O₂ and N₂ together, having their own selective mode. A second plasma is used for measuring independently the H₂O concentration alone having its own flow path specifically designed for moisture analysis. And a third plasma combining a plasma converter system is used for measuring the trace CnHM. This third plasma system is designed to ensure that the optic used for measuring the CnHM isn't submitted to carbon deposit contamination.

FEATURES:

The instrument comes with a touchscreen interface and a keypad that facilitate the navigation through the different menus. It has one 4-20mA analog output per impurity. Each impurity has 2 ranges of operation and an individual ID range contact. It also has 2 configurable alarm contacts and one status contact. The unit has an automatic proportional valve for controlling the sample flow rate and a manual valve for adjusting the sample bypass flow rate.

Based on dual plasma operation, a safe mode has been implemented if the oil level goes over a certain concentration. It protects the alternative plasmas to be contaminated with carbons to guarantee a long-term operation in presence of dirty Helium gas containing high level of oil.

CONCLUSION:

The LD8000 MultiGas uses a parallel plasma system configuration that is individually selective to each measured gas to avoid the interferences from other impurities. Using this technique, the LD8000 becomes the right online instrument to be used for Helium purity for monitoring multiple impurities in a single unit on cryogenic installation.

APPLICATION NOTE

LD16-07



Measurement of impurities in UHP Argon using the MultiDetek 2 and PlasmaDetek 2



▲ MultiDetek2

▲ PlasmaDetek2

Argon is a widely used gas in different needs such as steel industries, air separation, welding, purging, chemical plants, semiconductor and others. Having a good analytical tool is mandatory to ensure the required purity of argon.

The most popular technique for UHP argon analysis is to detect trace impurities by gas chromatography. Some of the most common technologies will use a combination of multiple detectors to achieve the analysis requirements. Most commonly used are FID (flame ionization detector) combined with PDD (pulse discharge detector). This technique requires the need of helium as carrier gas what is an expensive gas to be used as carrier gas for the analysis of H₂-N₂-CO-CO₂. The analyses of hydrocarbons will be performed using the FID what requires extra cost due to air and fuel. On top of that, the oxygen analysis must be performed using a separated trace oxygen analyzer due to the co elution of argon and oxygen in the gas chromatography system with helium ionization detection technique.

LDETEK SOLUTION:

The MultiDetek 2 combined with the PlasmaDetek 2 detector provides an ideal solution to measure the different impurities in UHP argon. With the PlasmaDetek 2, based on plasma emission detection, impurities in low ppb can be easily detected.

The system is simply configured with 3 channels and one plasma detector. Each channel has its own chromatography column mounted in a compact isothermal oven. A simple injection with sampling loop technique mounted on a diaphragm valve is used to introduce the sample gas to the detector.

Channel 1 to trace H₂-O₂-N₂-CH₄-CO
 Channel 2 to trace CO₂
 Channel 3 to trace NMHC (NMHC can be measured as required hydrocarbon equivalent depending on the need)

A diaphragm valve network is used for synchronizing the impurities to the plasma detector.

Figure 1 shows a chromatogram of such system with a standard gas containing trace impurities in a balance of Argon. Figure 2 shows the LDL that such Argon purity system can achieve based on noise level to signal ratio calculation.

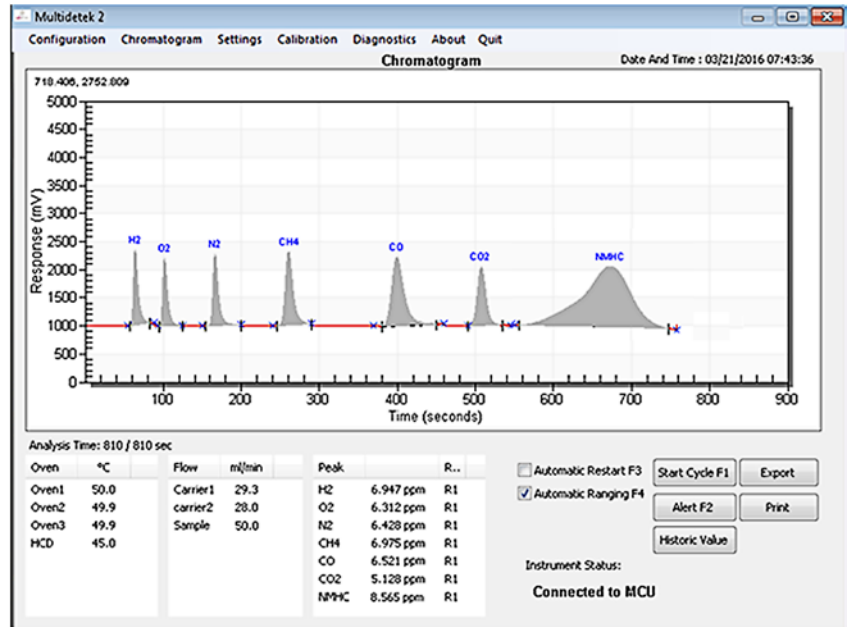

Figure 1

COMPONENT	CONCENTRATION	PEAK HEIGHT	NOISE	LDL (3X NOISE)
H ₂	6.947 ppm	1391 mV	2.5 mV	0.037 ppm
O ₂	6.312 ppm	1311 mV	2.1 mV	0.030 ppm
N ₂	6.428 ppm	1377 mV	1.0 mV	0.014 ppm
CH ₄	6.975 ppm	1390 mV	2.0 mV	0.030 ppm
CO	6.521 ppm	1270 mV	2.6 mV	0.040 ppm
CO ₂	5.128 ppm	1168 mV	2.3 mV	0.030 ppm
NMHC	8.565 ppm	1201 mV	1.6 mV	0.034 ppm

Note: other LDL could be obtained with different injection volume and chromatographic condition

Figure 2

CONCLUSION:

Using the MultiDetek 2 compact GC, it becomes the most convenient solution for argon purity analysis. It is a maintenance free system that offers the required performances. The use of argon as carrier gas entails a low cost of operation. On top of that, the MultiDetek2 offers all the features required by the industrial market for such type of application.

APPLICATION NOTE

LD16-08



Measurement of hydrocarbons in UHP Oxygen using the MultiDetek 2 and PlasmaDetek-E



▲ MultiDetek2

▲ PlasmaDetek2

This application note shows different methods that have been developed by LDetek for measuring the hydrocarbons in a stream of Oxygen (other matrixes can be analysed as well since the PlasmaDetek-E is strictly selective to hydrocarbons). This application note is the continuity of the application note LD16-02. It is then suggested to first read the LD16-02 to be advised about the technology that was used.

LDETEK SOLUTION:

The chromatograms shown in figure 1 and in figure 3 have been performed using a single column with a Plasmadetek-E. The system uses nitrogen as a unique carrier gas. The simplicity of this configuration makes this solution very efficient and simple for operation. No maintenance is required for such micro plasma based system.

Method for chromatogram in figure 1:

The MultiDetek2 configuration uses a 10 port diaphragm valve mounted in an injection/backflush mode. The sample gas is then introduced in the packed porous polymer type column for eluting the Air/O₂ followed by CH₄ in one direction to the detector before to reverse the flow in the column to get the NMHC redirected to the detector. The selective mode of the PlasmaDetek-E makes the detector being strictly selective to hydrocarbons and makes oxygen/air being invisible to the detector. The detector response and LDLs are demonstrated in figure 2. Please note that different performances can be achieved depending on the maximum and minimum ranges required.

Method for chromatogram in figure 3:

Using the same valve configuration combined with a different column type and system conditions, the analysis of separated C₂'s becomes possible. For some applications, where it is critical to measure C₂s individually, especially acetylene at low concentrations, this method is preferred. The addition of C₃+ measurement can be done in the same system to cover the whole hydrocarbon analysis solution. It offers better accuracy, sensitivity and simplicity than conventional FID or Argon plasma method. Figures 4-5 and 6 show an example of performances using this method in real life conditions.

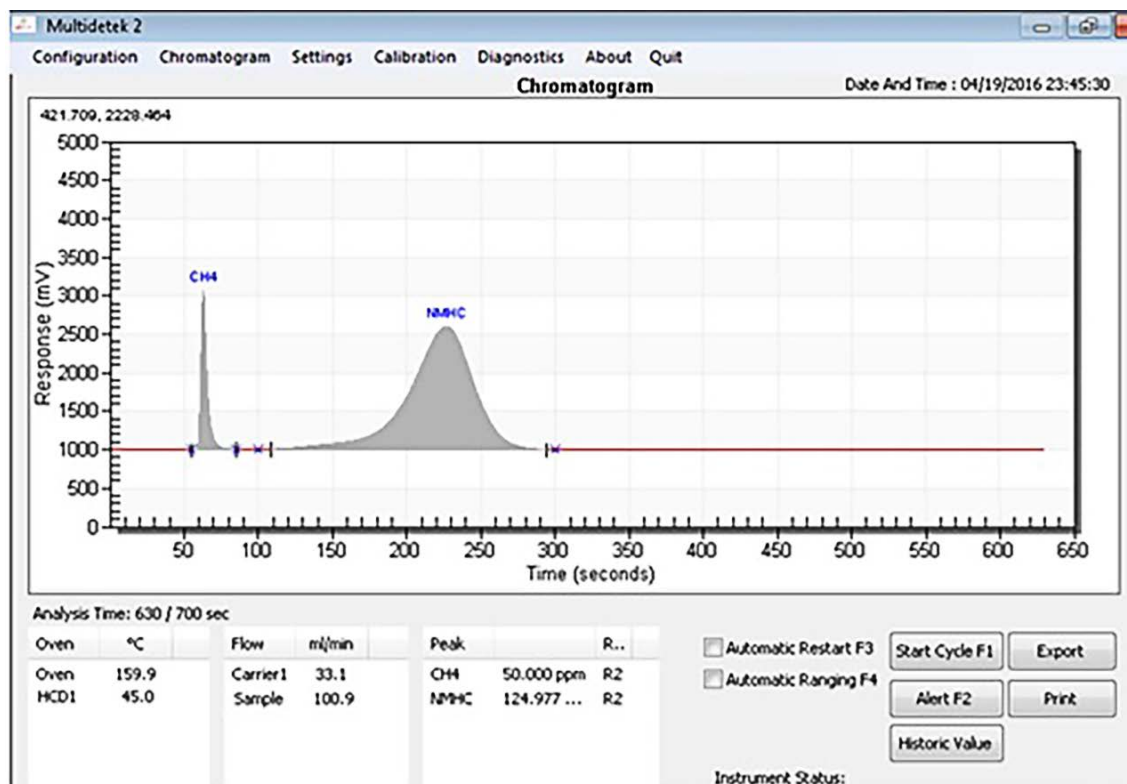

Figure 1: Chromatogram of CH₄ & NMHC in oxygen matrix

COMPONENT	CONCENTRATION	PEAK HEIGHT	NOISE	LDL (3X NOISE)
CH ₄	50.000 ppm	2211 mV	0.8 mV	0.054 ppm
NMHC	124.977 ppm	1622 mV	0.4 mV	0.092 ppm

Note: other LDL could be obtained with different injection volume and chromatographic condition

Figure 2

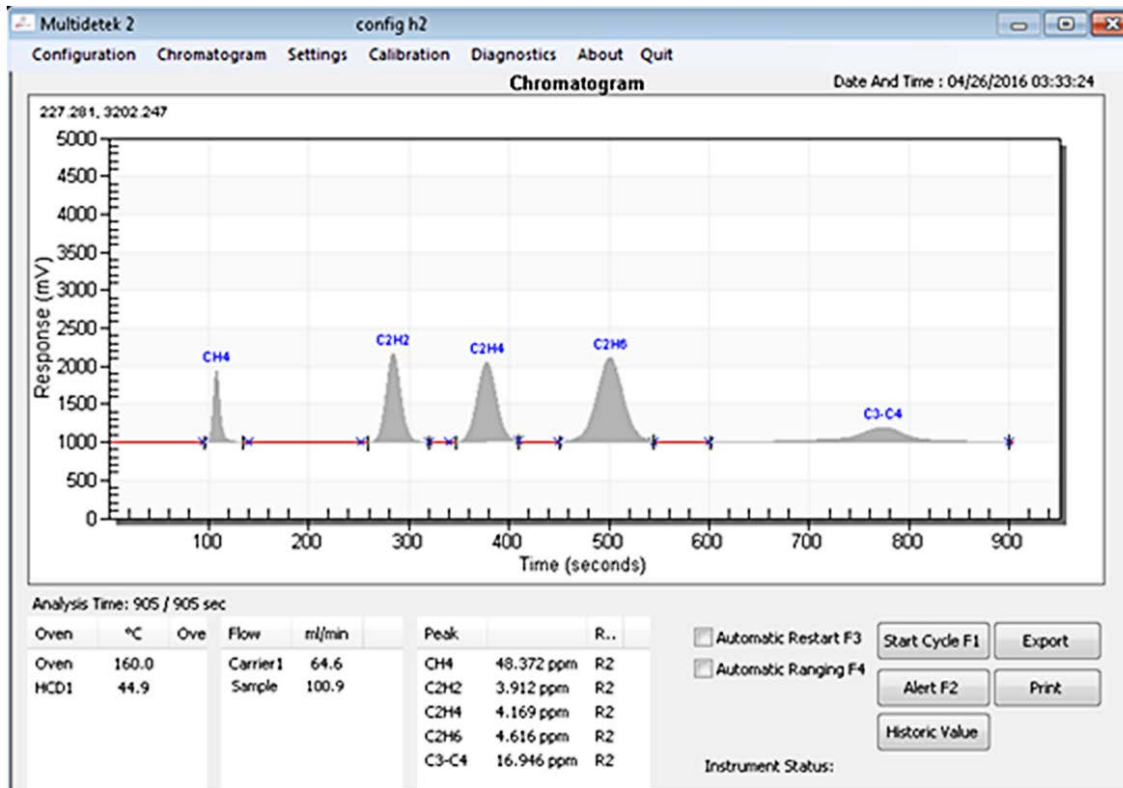

Figure 3: Chromatogram of trace CH₄, C₂H₂, C₂H₄, C₂H₆ & C₃+ in oxygen matrix

COMPONENT	CONCENTRATION	PEAK HEIGHT	NOISE	LDL (3X NOISE)
CH ₄	48.372 ppm	951 mV	0.3 mV	0.046 ppm
C ₂ H ₂	3.912 ppm	1241 mV	3.3 mV	0.031 ppm
C ₂ H ₄	4.169 ppm	1111 mV	3.3 mV	0.037 ppm
C ₂ H ₆	4.616 ppm	1146 mV	3.3 mV	0.040 ppm
C ₃ +	16.946 ppm	220 mV	0.9 mV	0.207 ppm

Note: other LDL could be obtained with different injection volume and chromatographic condition

Figure 4

Historic Values

ne	CH4	C2H2	C2H4	C2H6	C3+
/2016 04:23:29	7.278	7.368	7.252	6.947	23.382
/2016 04:08:18	7.283	7.365	7.250	6.947	23.383
/2016 03:53:07	7.281	7.364	7.253	6.955	23.397
/2016 03:37:56	7.282	7.361	7.246	6.942	23.387
/2016 03:22:45	7.289	7.362	7.253	6.954	23.409
/2016 03:07:34	7.290	7.368	7.254	6.965	23.422
/2016 02:52:23	7.280	7.369	7.259	6.968	23.428
/2016 02:37:12	7.265	7.369	7.260	6.960	23.419
/2016 02:22:01	7.278	7.377	7.266	6.965	23.419
/2016 02:06:50	7.293	7.379	7.264	6.960	23.406
/2016 01:51:39	7.275	7.382	7.269	6.951	23.417
/2016 01:36:28	7.276	7.385	7.266	6.965	23.420
/2016 01:21:17	7.290	7.390	7.268	6.980	23.424
/2016 01:06:06	7.288	7.390	7.273	6.983	23.453

More... On Chart... Print Ok Delete Cancel

Figure 5: Example of stability results over 10 consecutive cycles

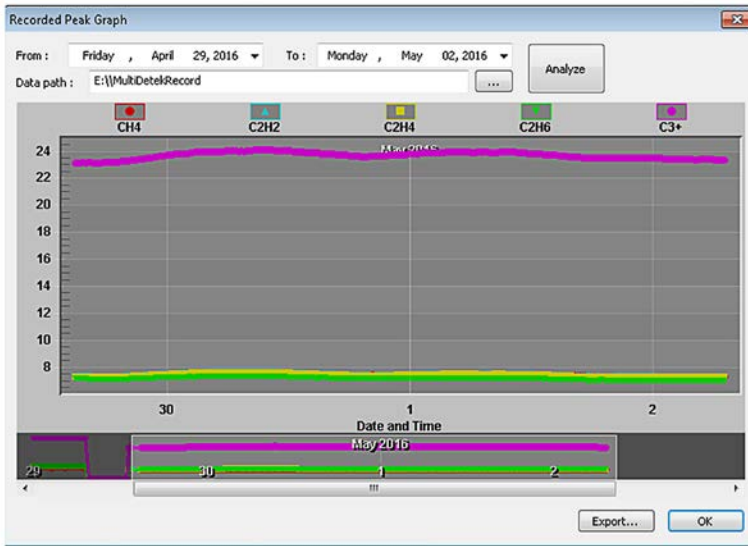

Figure 6: Example of stability results over a 3 day period

3.0 APPLICATION NOTES

APPLICATION NOTE

LD16-09



Measurement of trace impurities in UHP hydrogen



▲ MultiDetek2

▲ PlasmaDetek2

The production of UHP hydrogen requires analysis of trace impurities to control and certify the gas purity. Multiple instruments are usually dedicated to this task. Combining everything in the same instrument, the MultiDetek2 compact gas chromatograph is very efficient for this type of requirement. The detection down to part per billion can be achieved, what makes the instrument capable of certifying different hydrogen grades.

LDETEK SOLUTION:

Most of the gas chromatographs will use some combinations of hydrogen traps or membranes for measuring some impurities like Ar-O₂ and N₂ at low part per billion to eliminate the interference from hydrogen. The selectivity of the PlasmaDetek2 detector has the ability to measure those difficult impurities down to ppb level without the use of any hydrogen traps or membranes. It reduces the operation cost and simplifies the running operations of the system.

The configuration has 5 channels all converging in 3 different plasma detectors as follows:

- ▶ **Channel#1:** Measuring CH₄-CO₂ with HayeSep columns merging in plasma#1
- ▶ **Channel#2:** Measuring O₂-N₂ with Molecular Sieve columns merging in plasma #1
- ▶ **Channel#3:** Measuring NMHC with HayeSep column merging in plasma #2
- ▶ **Channel#4:** Measuring CO with Molecular Sieve column merging in plasma #2
- ▶ **Channel#5:** Measuring Ar with ArgoTek* column merging in plasma #3

*ArgoTek column is manufactured by LDETEK to offer the trace argon separation from matrix Oxygen or Hydrogen. The column is packed type operating at 45 Celsius / 20 sccm helium carrier flow rate. With these conditions, the column offers the desired separation for measuring part per billion argon in either oxygen or hydrogen.

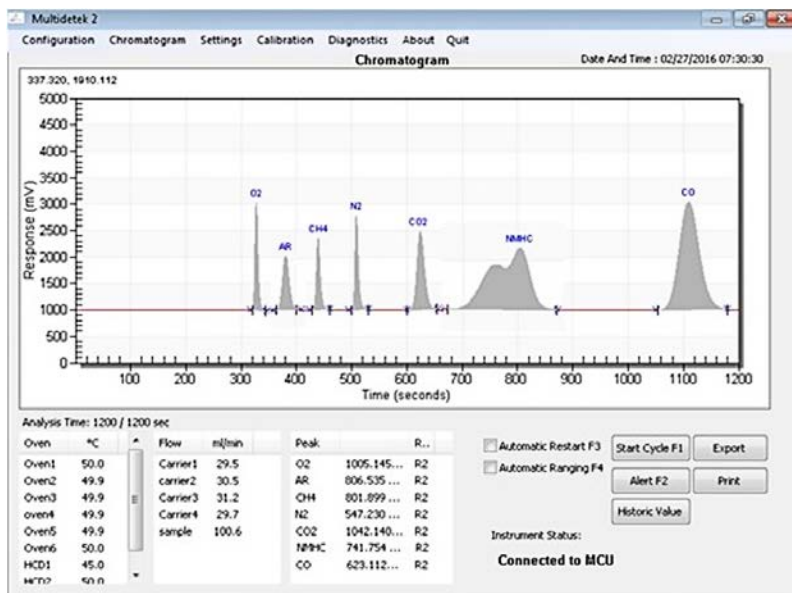

The three plasma detectors are respectively configured with the appropriate optical filters for blocking the hydrogen matrix and focussing on the dedicated impurities. This plasma configuration allows the analysis of multiple impurities in one single compact gas chromatograph unit.

Figures 1 and 2 show an example of results that such configuration can achieve for measuring low ppb/ppm concentrations of UHP hydrogen.

Figure 1: chromatogram of trace impurities in UHP hydrogen

COMPONENT	CONCENTRATION	PEAK HEIGHT	NOISE	LDL (3X NOISE)
O ₂	1005.1 ppb	2090 mV	2.1 mV	3.02 ppb
Ar	806.5 ppb	1017 mV	0.8 mV	1.90 ppb
CH ₄	801.8 ppb	1415 mV	1.6 mV	2.71 ppb
N ₂	547.2 ppb	1821 mV	1.4 mV	1.26 ppb
CO ₂	1042.1 ppb	1500 mV	2.2 mV	4.58 ppb
NMHC	741.7 ppb	1299 mV	2.2 mV	3.76 ppb
CO	623.1 ppb	2055 mV	5.1 mV	4.63 ppb

Note: other LDL could be obtained with different injection volume and chromatographic condition

Figure 2

CONCLUSION:

The analysis of UHP hydrogen can be performed using this LDetek solution that combines a selective plasma detector configuration, a complete industrial compact gas chromatograph system, a unique separation column type with an impressive expertise in this field of application. Having all this makes LDetek solution perfect for this type of industrial application.

APPLICATION NOTE

LD16-10



Measurement of trace Ar-Kr and N2 in a bulk gas Oxygen



▲ MultiDetek2

▲ PlasmaDetek2

Detecting and measuring trace Ar-Kr and N2 in a bulk gas Oxygen without the need of a cryogenic system, or a trapping adsorbent or an extra long column as generally used to measure trace ppb/ppm Argon as impurity from bulk Oxygen and for separating Krypton and Nitrogen.

LDETEK SOLUTION:

Using the compact MultiDetek2 gas chromatograph, with a dual channel mode merging in one PlasmaDetek2 (PED) detector, the analysis of trace Ar-Kr and N2 can be realized easily in a robust and maintenance free system.

- ▶ **Channel#1:** Used for measuring trace Argon in bulk Oxygen with the Argotek* column. The sample gas is injected using a standard 6 ports diaphragm valve directly in the packed type column that operates at isothermal temperature and with a fix carrier flow rate.
- ▶ **Channel#2:** Used for measuring trace Krypton and Nitrogen in bulk Oxygen with the HSR-Etek* column. The sample gas is injected using a standard 6 ports diaphragm valve directly in the packed type column that operates at isothermal temperature and with a fix carrier flow rate.

*ArgoTek column is manufactured by LDetek to offer the trace argon separation from matrix Oxygen. The column is packed type operating at 45Celsius/20sccm helium carrier flow rate. With these conditions, the column offers the desired separation for measuring part per billion argon in oxygen. (more details appear in application note LD12-3)

*HSR-Etek column is manufactured by LDetek to offer the trace Krypton and Nitrogen separation from matrix Oxygen. The column is packed type operating at 45Celsius/20sccm helium carrier flow rate. With these conditions, the column offers the desired separation for Kr/N2. (more details appear in application note LD12-7)

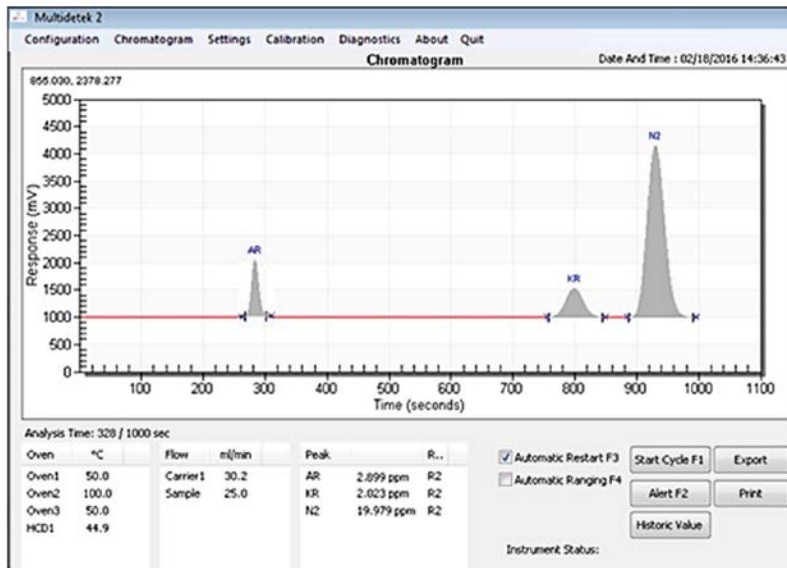

Figures 1 and 2 show an example of results that such configuration can achieve for measuring low ppb/ppm concentrations in bulk oxygen.

Figure 1: chromatogram of trace impurities in Oxygen

COMPONENT	CONCENTRATION	PEAK HEIGHT	NOISE	LDL (3X NOISE)
Ar	2.899 ppm	1091 mV	0.7 mV	5.6 ppb
Kr	2.023 ppm	503 mV	0.8 mV	9.6 ppb
N2	19.979 ppm	3211 mV	0.7 mV	13.0 ppb

Note: other LDL could be obtained with different injection volume and chromatographic condition

Figure 2

CONCLUSION:

The analysis of specific trace impurities in bulk Oxygen can be performed using this LDetek solution that combines a selective plasma detector with the right chromatography solution. It gives a robust and maintenance free system. Other impurities can be added to this system simply by adding extra channels.

APPLICATION NOTE

LD16-11



Measurement of trace impurities in multiple bulk gases



▲ MultiDetek2

▲ PlasmaDetek2

Having an analytical system that is able to measure multiple impurities in different bulk gases is sometimes required. It is usually a big challenge to combine all the hardware in the same instrument.

LDETEK SOLUTION:

The MultiDetek2 (compact gas chromatograph)

This compact gas chromatograph can handle up to 3 detectors with 6 parallel chromatographic channels through a network combining up to 10 diaphragm valves and 12 chromatographic columns. It opens the doors to many applications requiring multiple bulk gases analysis using the same compact analytical instrument.

One configuration (method) is pre programmed for each bulk gas analysis requirement. This way, the user can simply load the desired configuration and the analyser is ready to start the analysis. As well, the impurities can be independently configured with specific ranges and minimum detection limits.

No external PC is required since the robust industrial PC is mounted in the instrument and gives access to a data storage capacity. The instrument can be controlled remotely through the Ethernet connectivity. All industrial communication protocols are accessible. Automatic or manual report printing can be handled.

The LDGSS (stream selector)

Multiple bulk gases analysis usually requires a stream selector system being able to be controlled locally or remotely. A manual switch is available on the front to select manually the desired stream. Otherwise, the stream can be selected via the MultiDetek2 interface. The interface gives the possibility to edit the names of the streams, to program multiple sequences and to set specific purging time between each stream. The streams can also be selected and identified by a standard DCS system through a dry contacts network.

This ultra high purity system offers a quick response time due to its dead volume free design. An adjustable sample purge valve and flow meter is independent to each stream to adjust the gas line purging before the stream selector. A purge gas being the same of the carrier gas of the MultiDetek2 is used to keep the ambient air away of the analytical flow path to ensure ultra high purity analysis gas for all the streams. Specifically when trace impurity of a bulk gas is also the pure gas of its neighbor stream that was just analysed in the previous analysis. The design of a back purged stream selector system is very important and this is what is included in this solution.

For this application note, since the analysis of hydrogen and oxygen is required, 2 LDGSS systems have been used to avoid mixing of both gases together. The purge gases are independent to each stream selector to avoid any chance of mixing oxygen and hydrogen. The LDGSS used for Oxygen can be certified for O2 Clean.

The COMPACT-LDP1000 (gas purifier)

The gas purifier generates ultra high purity carrier gas certified for a total of 10ppb total impurities. This compact high capacity gas purifier keeps the system clean and intact even if carrier gas cylinders purity can vary from batch to batch introducing a variation of baselines which has impact on the accuracy of the analytical device. Or in another instance, if by mistake, an air contamination gets in the carrier flow path during the process of changing the carrier gas cylinder.

The gas purifier can also communicate in real-time with the MultiDetek2 to inform about his status. In the event of a default, it generates an alarm in the MultiDetek2 to automatically advise about the fault.

The LDRACK (certified cabinet)

The complete solution comes assembled and certified in a cabinet. Such system is fully tested to certify the analytical response time when switching between streams. This is more than necessary when low ppb analysis of nitrogen and oxygen are targeted. It doesn't only guarantee that the sample gas lines offers no dead volume and leaks, but also guarantees that the carrier gas lines are properly mounted. It is the best practice to get the best analytical performances especially when traces of impurity at ppb level are also present in ambient air must be detected.

THE COMPLETE SOLUTION

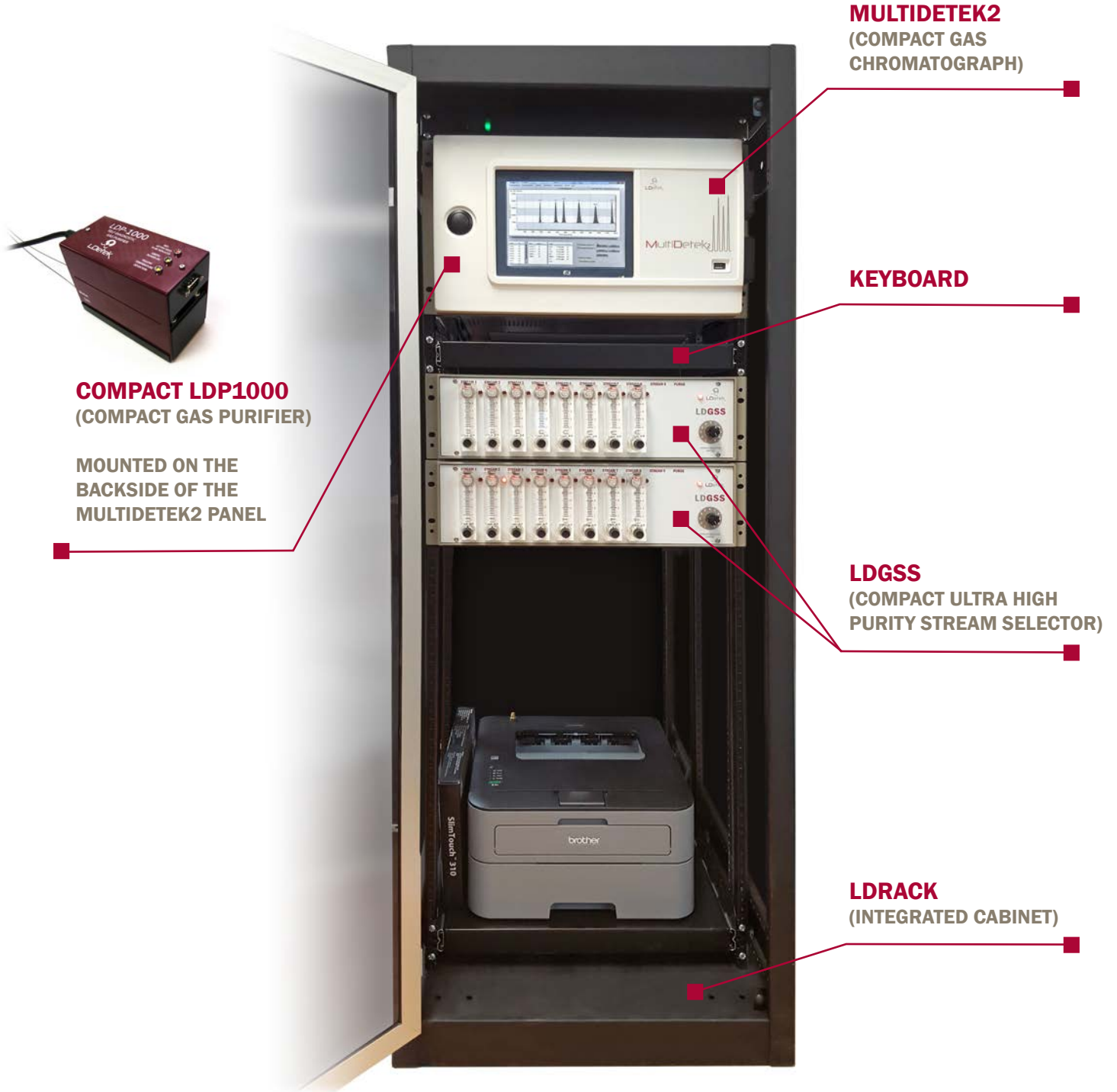

COMPACT LDP1000
(COMPACT GAS PURIFIER)

MOUNTED ON THE
BACKSIDE OF THE
MULTIDETEK2 PANEL

MULTIDETEK2
(COMPACT GAS
CHROMATOGRAPH)

KEYBOARD

LDGSS
(COMPACT ULTRA HIGH
PURITY STREAM SELECTOR)

LDRACK
(INTEGRATED CABINET)

RESULTS:

Figures 1 to 12 show some examples of results that such configuration can achieve for measuring low ppb/ppm concentrations of multiple trace impurities in multiple bulk gases.

In this example, trace impurities H₂-Ar-O₂-N₂-CH₄-CO-CO₂ in bulk gases Argon, Carbon dioxide, Hydrogen, Helium, Nitrogen and Oxygen were measured.

An optimized method for high range(HR) covering up to 1000ppm and another method for low range(LR) to ensure good peak detection and stability down to 10ppb are used. This dual methods technique gives the possibility to extend the dynamic range as desired. Conventional analysis techniques will tend to have some limitations on the low ppb detection when a high ppm analysis is required. The linearity and accuracy of our system is improved by having an optimized method for a specific analysis range.

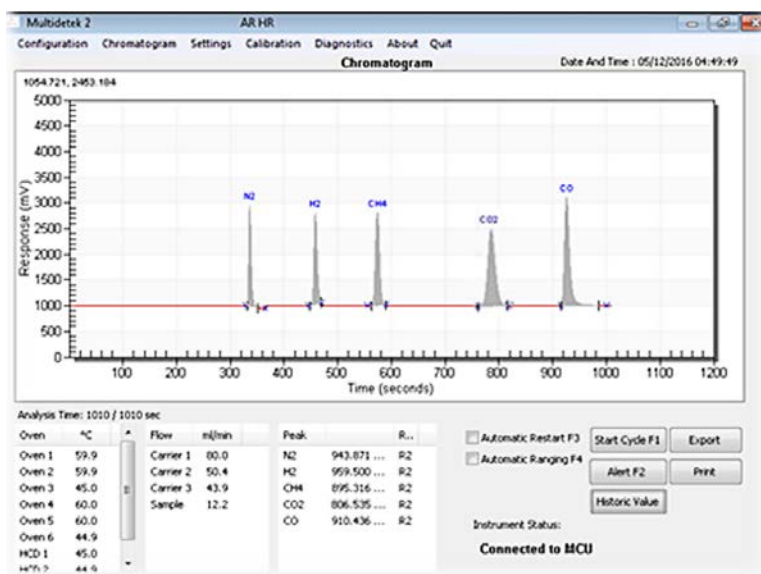

Figure 1: chromatogram of trace impurities in Argon (High range ppm)

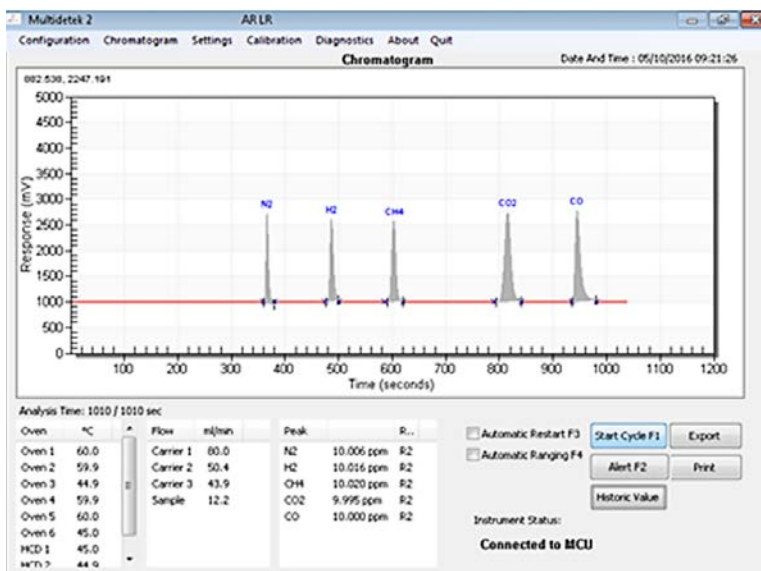

Figure 2: chromatogram of trace impurities in Argon (Low range ppb/ppm)

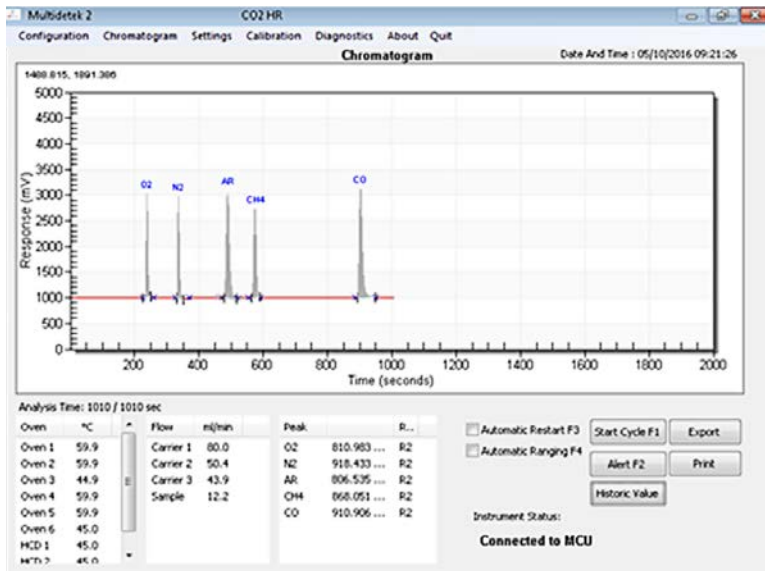

Figure 3: chromatogram of trace impurities in Carbon Dioxide (High range ppm)

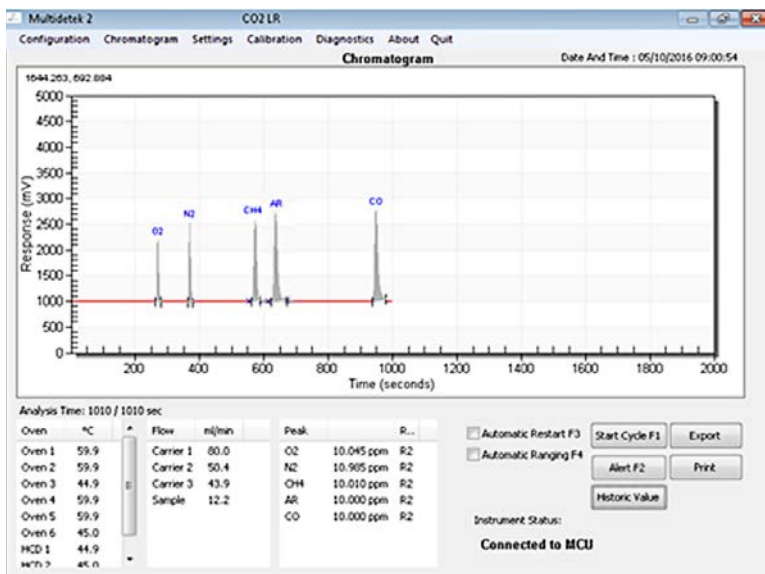

Figure 4: chromatogram of trace impurities in Carbon Dioxide (Low range ppb/ppm)

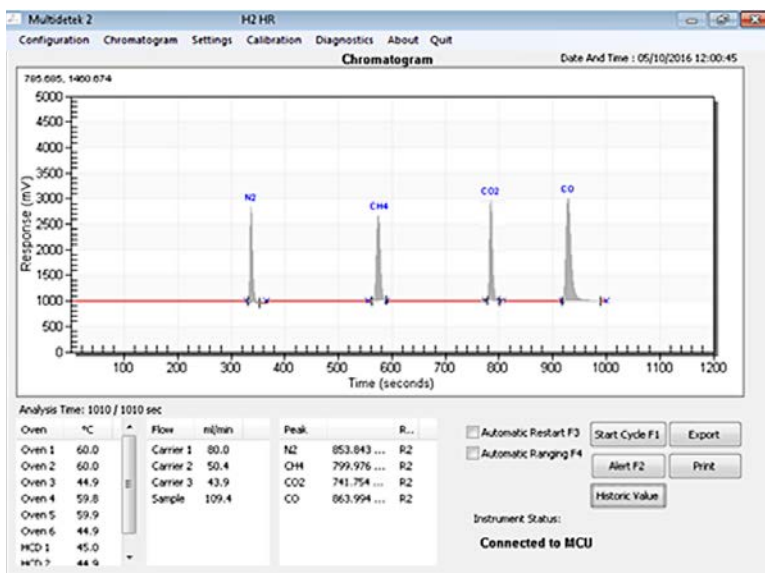

Figure 5: chromatogram of trace impurities in Hydrogen (High range ppm)

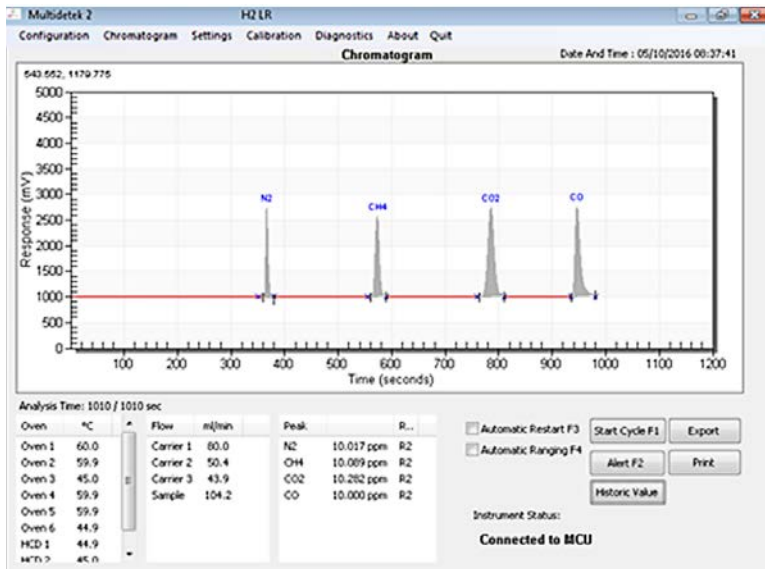

Figure 6:
chromatogram of trace impurities in Hydrogen
(Low range ppb/ppm)

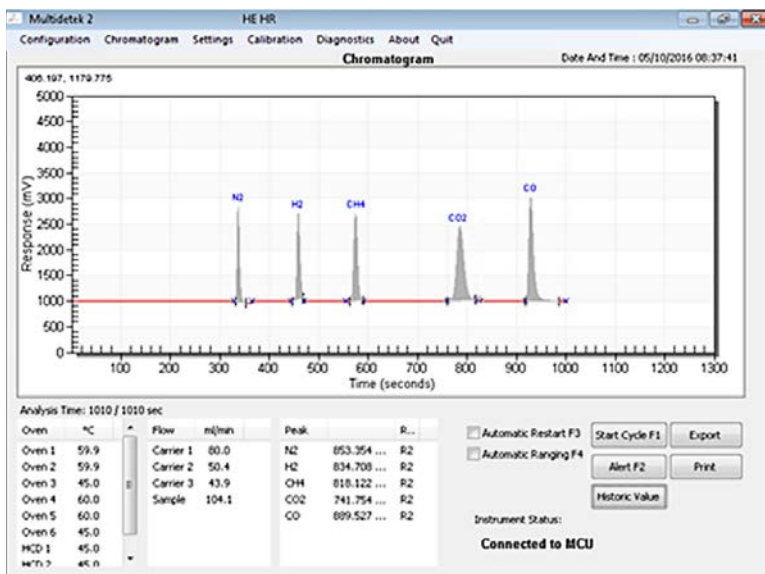

Figure 7:
chromatogram of trace impurities in Helium
(High range ppm)

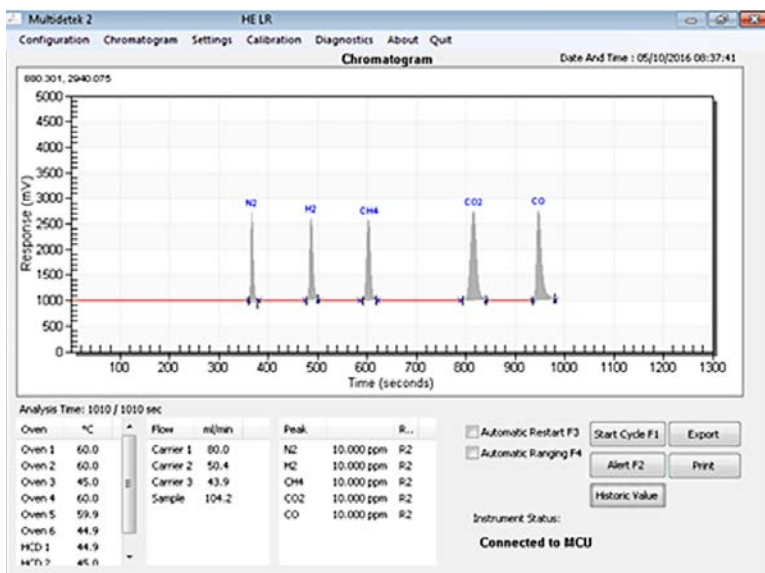

Figure 8:
chromatogram of trace impurities in Helium
(Low range ppb/ppm)

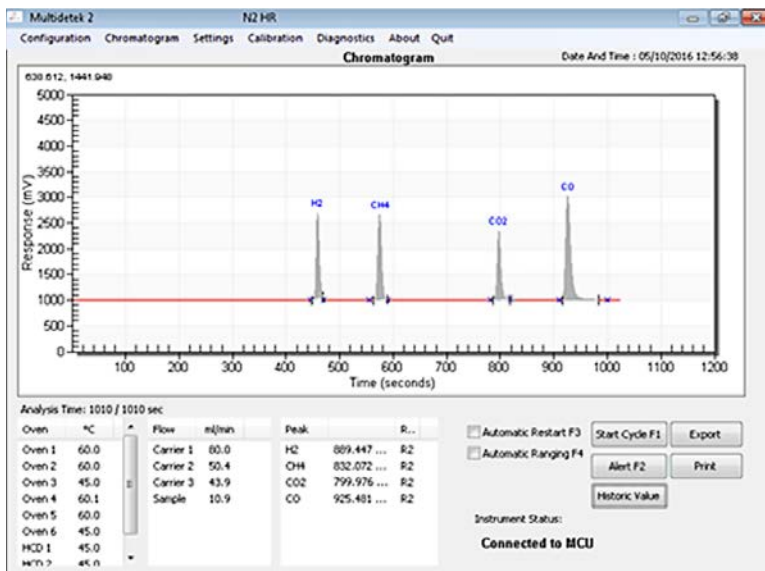

Figure 9:
chromatogram of trace impurities in Nitrogen
(High range ppm)

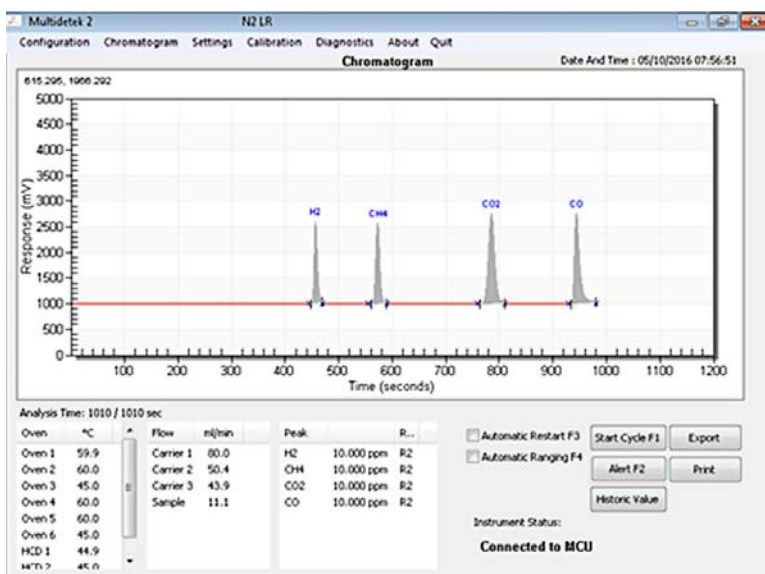

Figure 10:
chromatogram of trace impurities in Nitrogen
(Low range ppb/ppm)

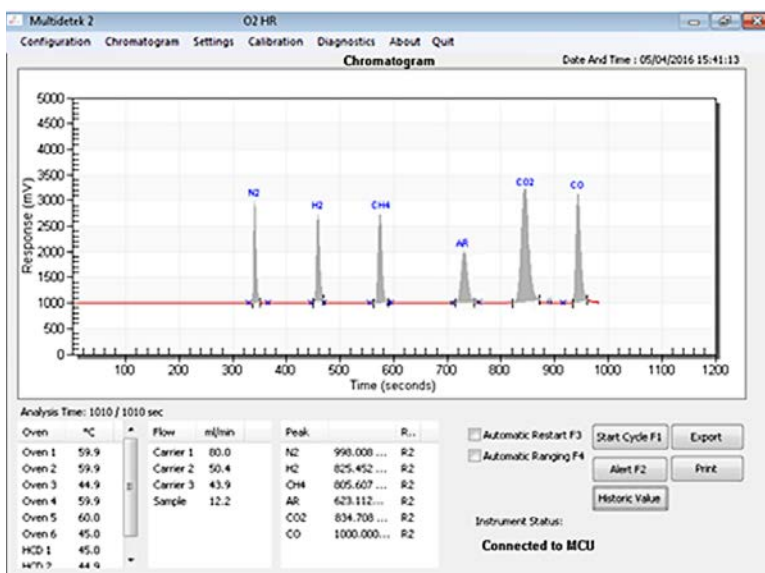

Figure 11:
chromatogram of trace impurities in Oxygen
(High range ppm)

COMPONENT	CONCENTRATION	PEAK HEIGHT	NOISE	LDL (3X NOISE)
H2 (fig.8)	10.000 ppm	1621 mV	0.7 mV	12.9 ppb
Ar (fig.4)	10.000 ppm	1780 mV	0.4 mV	6.7 ppb
O2 (fig.4)	10.045 ppm	1320 mV	0.6 mV	13.7 ppb
N2 (fig.2)	10.006 ppm	1821 mV	0.5 mV	8.2 ppb
CH4 (fig.6)	10.089 ppm	1612 mV	0.6 mV	11.3 ppb
CO (fig.10)	10.000 ppm	1806 mV	0.9 mV	14.9 ppb
CO2 (fig.6)	10.282 ppm	1823 mV	0.8 mV	13.5 ppb

Note: other LDL could be obtained with different injection volume and chromatographic condition

Figure 12

CONCLUSION:

Our complete integrated gas analysis solution guarantees the best performances and robustness for any applications combining multiple impurities in multiple streams and/or bulk gas types. It is compact and compatible with standards of the industry.

APPLICATION NOTE

LD19-05



Trace impurities in UHP Argon for hot isostatic pressing (HIP) and additive manufacturing (AM) industries with the MultiDetek2 analyser



Argon is a widely used gas in different needs such as steel industries, air separation, welding, purging, chemical plants, semiconductor and others. Having a good analytical tool is mandatory to ensure the required purity of argon.

This application note is the continuity of the LD16-07. In this application note, we will particularly covers the HIP (hot isostatic pressing) process in the steel industry with the use of the MultiDetek2 gas analyser GC for trace impurities in Argon.

What is the HIP?

HIP combines very high temperatures, very high pressures, and inert gas to eliminate porosity in castings and consolidate powder into dense materials. Temperatures are up to 2,000 deg C, pressures are up to 30,000 psi and UHP inert gas generally argon are the conditions required.

What is the utility of using HIP?

The hot isostatic pressing is used extensively to prolong the working life of components and protect them from environmental factors such as corrosion and abrasion. It provides thermal processing which improve material properties such as strength, durability and corrosion resistance, enabling manufacturers' components to work more efficiently with significantly extended operational lifetimes. It is used to alter the microstructure of materials, such as metals and alloys, to impart properties which benefit the working life of a component, for example: increased surface hardness, temperature resistance, ductility and strength. Hot isostatic pressing uses very high pressures in addition to high temperature to achieve engineering outcomes that are impossible by other methods. HIP is used to eliminate porosity in castings and consolidate encapsulated powders to dense materials. Dissimilar materials can be bonded together to manufacture unique, cost effective components.

What are the markets that require products to be manufactured from this HIP process?

HIP installations will process many tons of titanium, aluminium, steel and super-alloy castings, removing porosity and improving the performance of parts such as turbine blades and oilfield components. In almost all cases metals in any state require heat treatment to improve their properties, if components are to achieve desired levels of longevity and corrosion performance in use. Without heat treatment car engine components, for example, might last for hundreds of miles rather than the tens of thousands we expect. The use of the specialist surface technologies offers further improve in-use characteristics, particularly in severe environments such as in aircraft engines and in sub-sea oil & gas applications.

Why gas analysis is required for HIP?

An inert gas is required to prevent chemical reactions during the HIP process at elevated temperatures, making argon the ideal candidate. Monitoring of the HIP argon gas and its impurities is required to control the quality and repeatability of the HIP process.

The general quality control requires the analysis of the trace impurities in a range of 0-100ppm for H₂-O₂-N₂-CH₄-CO-CO₂-NMHC-H₂O in UHP argon.

HIP typical installation:

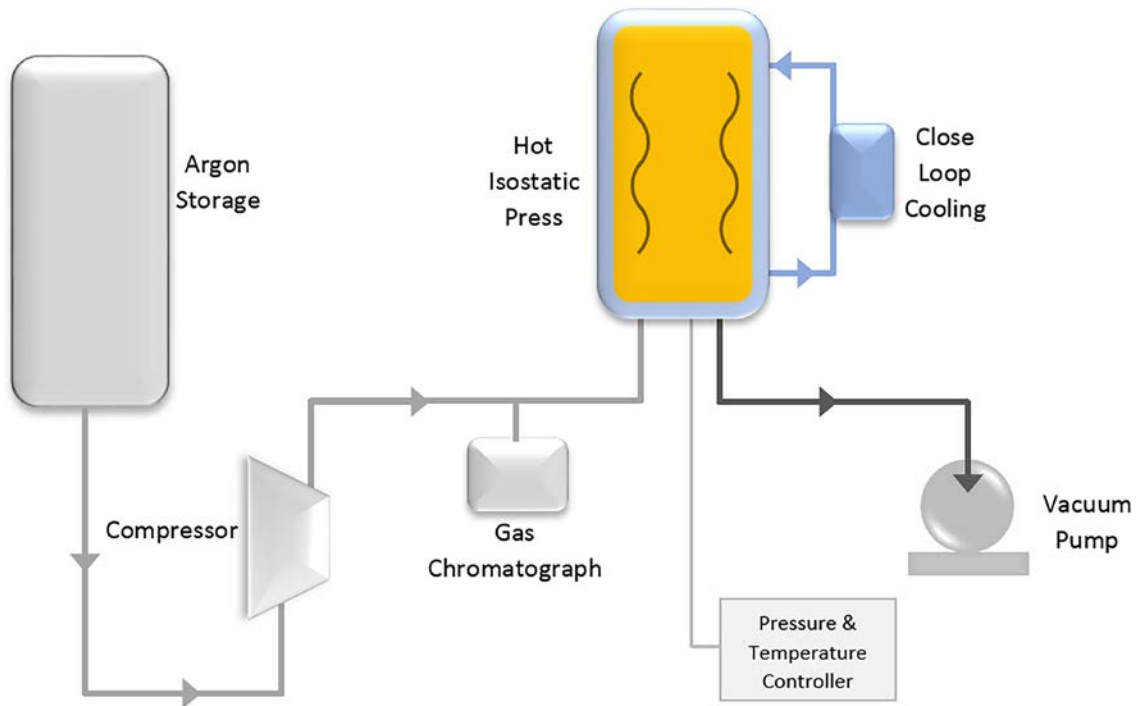

LDETEK SOLUTION:

The MultiDetek 2 combined with the PlasmaDetek 2 detector provides an ideal solution to measure the different impurities in UHP Argon.

The system is simply configured with 2 blocks, each one merging in one PED. Each block has its own chromatography column mounted in a compact isothermal oven. A simple injection with sampling loop technique mounted on a diaphragm valve is used to introduce the sample gas to the detector.

Block 1 is used to measure trace H2-O2-N2-CH4-CO and CO2

For block 1 configuration, a selection diaphragm valve is used for synchronizing the impurities coming out of the columns to the plasma detector. The PED is configured with selective optics for each measured impurity improving the sensitivity.

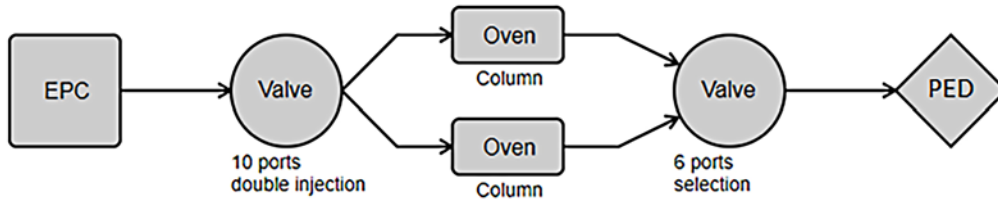

Block 2 is used to measure trace NMHC

The block 2 arrangement allows to inject light impurities to vent and by reverting the valve position, the C2s-C3s-C4s hydrocarbons are grouped together as one peak to form NMHC to the PED. The PED has the right optic, selective to hydrocarbons.

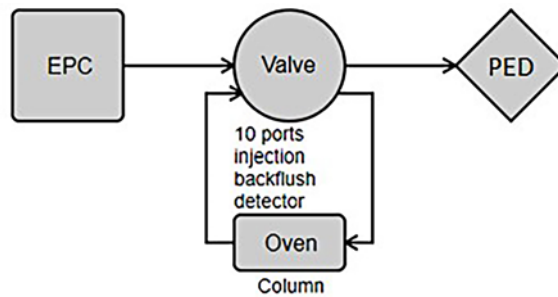

For the analysis of trace H2O, 2 solutions are offered depending of the requirements.

1. A Michell DewPoint sensor can be added to the MultiDetek2, connected in parallel. The 4-20mA output of the sensor is wired back to the MD2 analog input. Then, all results can be report on the GC interface. Going this way a LDL of 0.5ppm can be achieved for H2O impurity.



2. If an ldl lower than 0.5ppm is required, then a third block is mounted inside the MultiDetek2 containing a quartz crystal micro balance moisture sensor. Using this way, a span and zero calibration system is integrated inside the GC unit for calibrating the H2O sensor.

Block 3 is represented for measuring trace H2O

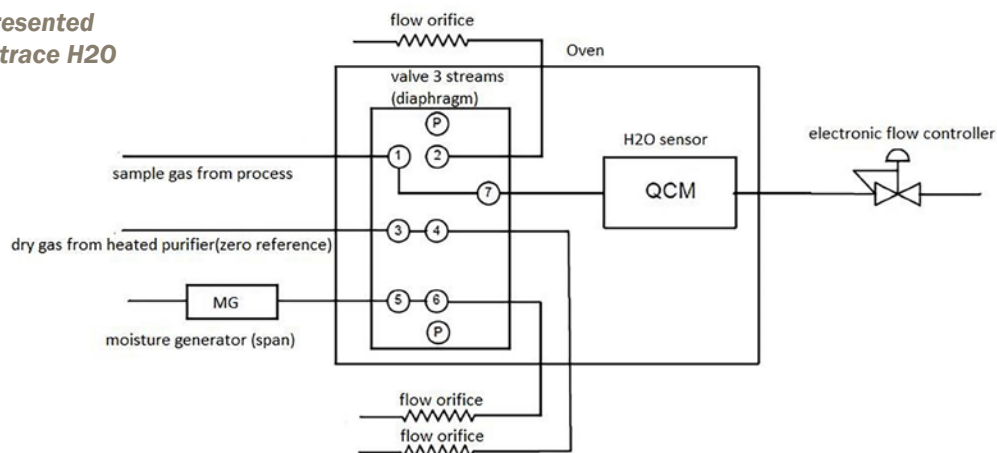

LDRACK INTEGRATED COMPLETE SOLUTION

3.0 APPLICATION NOTES



MULTIDETEK2
GC gas analyser for measuring trace H₂-O₂-N₂-CH₄-CO-CO₂-H₂O in UHP argon.

LDGSS
ultra high purity gas stream selector system for switching between the different streams and the span calibration gas (Up to 10 streams in one device is available).

LDP1000
heated gas purifier to generate UHP grade 99.999999% from grade 99.999% for carrier gas of the GC.

RESULTS:

A chromatogram of such system with a standard gas containing trace impurities in a balance of Argon. An analysis time of less than 10 minutes is required for H₂-O₂-N₂-CH₄-CO-CO₂ and by adding the NMHC impurity, the analysis time goes to 12 minutes.

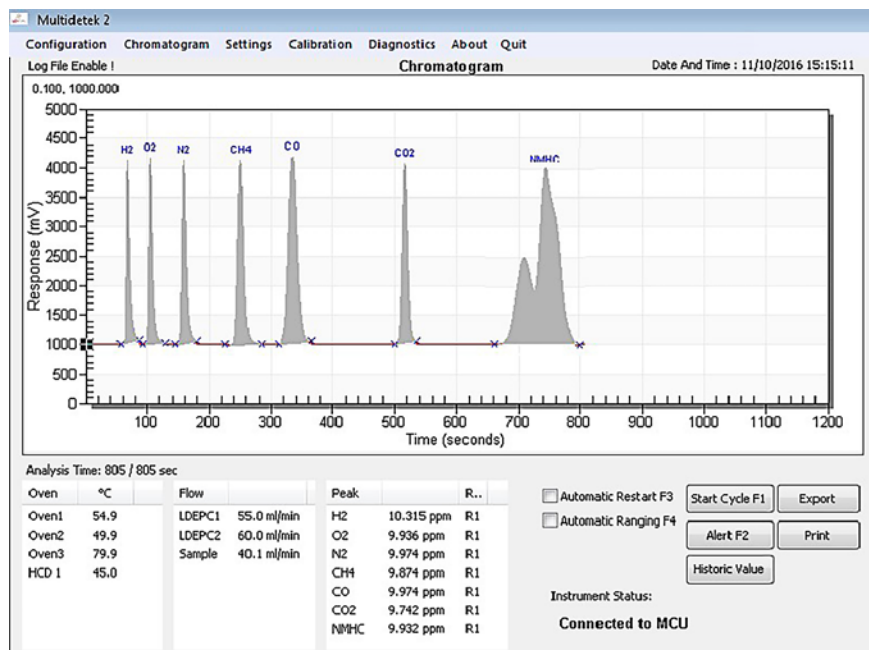

The following chart gives the limit of detection for such GC configuration

COMPONENT	CONCENTRATION	PEAK HEIGHT	NOISE	LDL (3X NOISE)
H2	10.315 ppm	3202 mV	2.4 mV	0.023 ppm
O2	9.936 ppm	3221 mV	2.1 mV	0.019 ppm
N2	9.974 ppm	3205 mV	1.0 mV	0.010 ppm
CH4	9.874 ppm	3201 mV	2.0 mV	0.019 ppm
CO	9.974 ppm	3251 mV	2.6 mV	0.024 ppm
CO2	9.742 ppm	3191 mV	2.3 mV	0.021 ppm
NMHC	9.932 ppm	3051 mV	2.1 mV	0.021 ppm

Figure 2 Note: other LDL could be obtained with different injection volume and chromatographic condition

CONCLUSION:

With the MultiDetek2 compact GC combined with PlasmaDetek2 detector, the analysis of trace impurities in UHP argon can be realized in one rackmount instrument with one type of detector. The use of argon as carrier gas entails a low cost of operation. On top of that, the MultiDetek2 offers all the features and industrial protocols/controls required by the industrial market for such type of application.

Our fully integrated solution LDrack combining the analytical instrument MultiDetek2 with our stream selector system LDGSS with the integrated analysis for trace H₂O makes a reliable turnkey solution for the HIP furnace manufacturers, 3D printer manufacturers and some controlled atmosphere manufacturers.

APPLICATION NOTE

LD20-04



MultiDetek2 with PlasmaDetek2 configured as online analyser for fast Crude Argon analysis



▲ MultiDetek2

▲ PlasmaDetek2

LDETEK SOLUTION:

In continuity to our application note LD12-06 that explains the benefit of measuring the trace N₂ in Crude Argon to improve the Argon production in ASU, this document will show the benefit of using our online trace N₂ in Crude Argon analyser for such type of application.

In some cases, when the oxygen concentration stays below a maximum level of 5%, it is strongly suggested to refer to our LD8000MG instrument that can measure trace nitrogen in such low percent oxygen level. Our application note LD13-03 well describes what our LD8000MG series with PED technology can offer.

When the Crude Argon analysis requires an oxygen level being over 5% up to 80-100%, then the use of our MultiDetek2 analyser with the PlasmaDetek2 detector mounted as an online gas analyser instrument is strongly suggested. Conventional gas analyser for such type of application will use a basic gas chromatograph which requires a certain analysis time and GC columns. In most cases, the analysis time isn't quick enough to be able to control and improve the Argon production level. Our MD2 analyser combined with the PED in a selective and sensitive mode can performs the nitrogen analysis in a crude argon sample gas without the need of having a GC column.

The MD2 uses a diaphragm injection valve with a micro sampling loop to inject through a straight copper catalyst-based bed. The combination of the highly selective/sensitive PED with the absorption bed makes the N₂ analysis possible within 50 seconds. With this quick analysis time, the Argon production can be improved to reduce the cost of production.

RESULTS

Chromatogram of trace ppm impurity N2 in Crude Argon sample gas (sample contains 90% Oxygen, balance Argon)

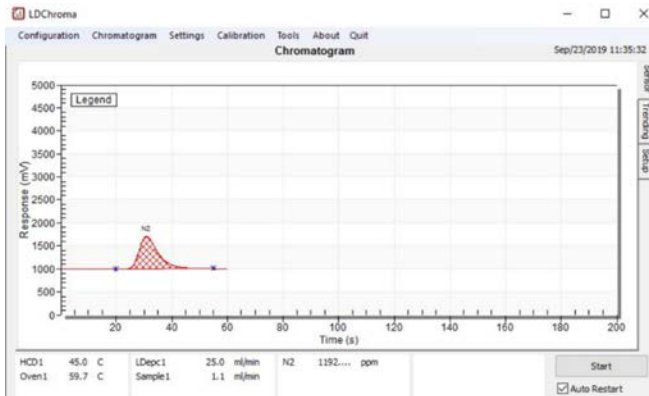

LDL is identified based on three times the noise level

COMPONENT	CONCENTRATION	PEAK HEIGHT	NOISE	LDL (3X NOISE)
N ₂	1192 ppm	765 mV	1.3 mV	6,07 ppm

Note: other LDL could be obtained with different injection volume and chromatographic condition

Repeatability is demonstrated here by running 12 consecutive cycles at a concentration of 1200ppm N2 in a sample gas containing 90% Oxygen balance Argon.

Start	N2
2019-09-21 04:04	1203.670 ppm
2019-09-21 04:03	1202.633 ppm
2019-09-21 04:02	1201.522 ppm
2019-09-21 04:01	1201.335 ppm
2019-09-21 03:59	1202.315 ppm
2019-09-21 03:58	1203.796 ppm
2019-09-21 03:57	1203.044 ppm
2019-09-21 03:56	1203.868 ppm
2019-09-21 03:55	1203.715 ppm
2019-09-21 03:54	1203.070 ppm
2019-09-21 03:53	1201.403 ppm
2019-09-21 03:52	1201.770 ppm

CONCLUSION:

The MultiDetek2 gas analyser combined with the PlasmaDetek2 detector offers the requirements for such type of application. The analysis time is quick enough to reduce the production cost of Argon in ASU. Compared to a conventional GC method, the MultiDetek2 online method here allows a straight and fast crude argon analysis. The method proposed in this document is rackmount, robust and industrial as required by this market. The system also offers a full remote control. The industrial communication protocols are all built in and must simply be selected specifically for your requirements.

APPLICATION NOTE

LD20-06



Measuring trace O₂-N₂-H₂O for Lithium-Ion batteries inert atmosphere



▲ LD8000

▲ PlasmaDetek2
N₂

▲ Senz-Tx
O₂

▲ Easidew
H₂O

APPLICATION:

Batteries are used to convert electrical energy into a storable chemical energy in order to subsequently release the energy back as electricity at a later point in time. There is a continual race to increase the energy packed into batteries to improve their operability, broaden their range of applications and reduce their manufacturing cost.

They are miniaturised to house watches or implanted medical devices and are used on portable equipment such as smartphones, laptops and power tools. They are also found in communication devices such as satellites, emergency power such as UPS, robotics and heavy machinery. Their usage is gaining tremendous traction in the transport industry and fuel cells applications. They have more recently received a keen interest on the storage of renewable energies from wind and solar power to buffer electrical grid demands.

The production of lithium-ion battery cell consists of three main steps: Electrode manufacturing, cell assembly and cell finishing. High-temperature atmospheres are used for sintering of the precursors, inerting atmospheres, and the welding of cell tabs into a stack. Precisely controlled argon or helium atmospheres are typically used to prevent lithium from reacting with oxygen and nitrogen from an air atmosphere. Their presence would result in irreversible damage to the Lithium electrode by the formation of an oxide and a nitride.

The inerting argon atmosphere must equally remain moisture free to prevent it from reacting with the lithium-ion battery electrolyte to form hydrofluoric acid. The electrolyte decomposition rate increases at elevated temperatures, so the overall manufacturing process must be kept under dry conditions. When sealed inside the cell this strong acid can potentially cause short circuits and, in some cases, fire. Moisture emissions from the personnel must also be removed by dry air which is being continuously and accurately delivered to the production area, to prevent the electrolyte to chemically decompose.

Nitrogen, oxygen and water vapour must be kept at the trace ppm level to satisfy the best of industry standard. The LD8000 MultiGas online analyzer from LDetek is the ideal tool to control the atmosphere quality, as it combines the sensing technologies for each of these impurities in a single 3U or 4U rackmount chassis.

Nitrogen impurities are measured in a continuous gas stream using LDetek's patented Plasma Emission Detector (PED). By combining it with trace oxygen measurements using Ntron's Senz-Tx along with Michell Instruments' sensing technologies for moisture measurement, the MultiGas is a staple product to the industry which embodies the synergies of between PST entities. Michell Instruments also offers the precise chilled mirror technology in the S8000 product series for the water dew point measurement of the inerting gas or the dry room environments, with traceability to national metrological standards.

SOLUTION:

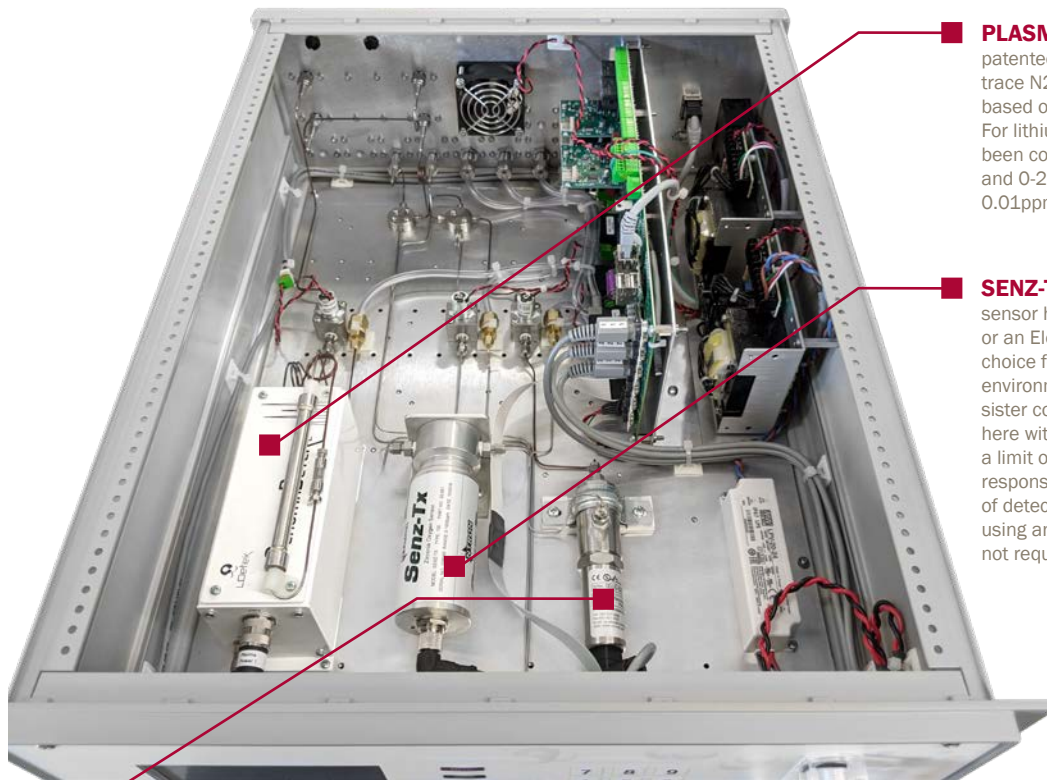

PLASMADETEK2

patented sensor for detecting ppb/ppm trace N₂ in inert environment. Technology based on its selective spectral emission. For lithium-ion application, the ranges have been configured at 0-200ppm, 0-20ppm and 0-2ppm with a limit of detection at 0.01ppm.

SENZ-TX

sensor having a choice between a Zirconia or an Electrochemical O₂ cell is the ideal choice for measuring trace O₂ in inert environment. This technology from our sister company NTRON has been configured here with a 0-20ppm, 0-200ppm range with a limit of detection at 0.5ppm using a fast response time zirconia sensor. A lower limit of detection of 0.1ppm can be achieved using an electrochemical sensor, but it was not required here.

EASIDEW

advanced ceramic moisture sensor technology-based hygrometers from our another sister company Michell has been used for the detection of trace moisture impurity. Configured here for measuring 0-20ppm, 0-200ppm, the sensor offers the required range for the application with a limit of detection being at 0.5ppm. In case of lower limit of detection requirement, the chilled mirror or the quartz crystal technologies can be used as well.

All the 3 sensors run in parallel having each an individual electronic flow controller to regulate the flow rate in a range of 100-200sccm for each sensor. On the front of the unit, a sample bypass purge rotameter is mounted to adjust the desired excess flow for adequate purging of the gas line upfront the instrument between 0-1LPM. All the internal flow path have been reduced to 1/16"OD coated stainless steel tubing to offer the best response time by keeping at minimum the surface volume. The coated tubing ensures to eliminate the surface absorption.

All the data are transmitted by an individual 4-20mA analog output per impurity. An additional serial communication port can be added if required. The interface has a touchscreen to navigate through the different menus. All this package in a 4U rackmount 19 inches industrial enclosure.

APPLICATION NOTE

LD21-01



Trace impurities measurement for synthetic diamond "grows" by chemical vapor deposition (CVD)

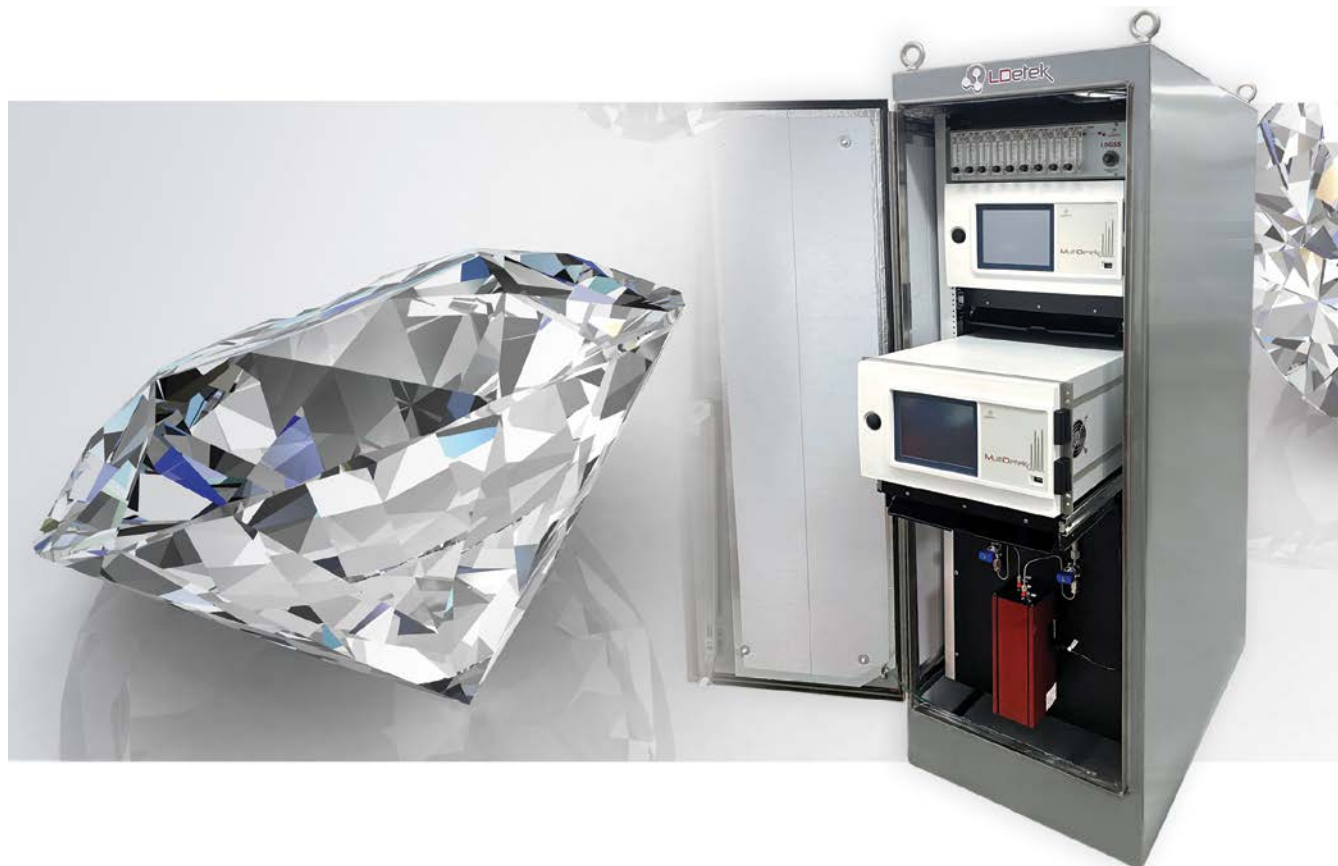

3.0 APPLICATION NOTES

HOW DO YOU GROW A LAB DIAMOND?

By recreating the conditions underneath the Earth that result in diamond growth: pressure, heat, & carbon.

Laboratory grown diamonds can be referred to as lab created diamonds, grown diamonds, synthetic diamonds, man-made diamonds, cultivated diamonds, or cultured diamonds.

Diamonds are grown all over the world in high-tech facilities staffed by scientists, engineers, and technicians. West to East, here are locations of significant diamond production:

- ▶ United States
- ▶ France
- ▶ Netherlands
- ▶ Ukraine
- ▶ Israel
- ▶ China
- ▶ Japan
- ▶ United Kingdom
- ▶ Belgium
- ▶ Germany
- ▶ Russia
- ▶ India
- ▶ Singapore

APPLICATIONS

- ▶ **Jewelry**
- ▶ **Electronics**
- ▶ **Machining and cutting tools**
- ▶ **Thermal conductor**
- ▶ **Optical material**

MANUFACTURING TECHNOLOGIES

Today, there are two main methods used to produce synthetic diamonds. The uses of high pressure and high temperature (HPHT) is still widely used because of its relatively low cost. The process involves large presses that can weigh hundreds of tons to produce a pressure of 5 GPa at 1500 °C. This method is mostly used for large industrial production. The second method, using chemical vapor deposition (CVD), creates a carbon plasma over a substrate onto which the carbon atoms deposit to form diamond. Other methods include explosive formation (forming detonation nano diamonds) and sonication of graphite solutions but are not so interesting.

The chemical vapor deposition by plasma is the method that allows the production of the best grade of synthetic diamond possible on earth in a relative short time. This method involves measuring the trace nitrogen in different high purity gases (mainly H₂ and CH₄) to accelerate the diamond growing and to improve the grade quality. For a proper trace N₂ analysis, the PlasmaDetek2 detector with the MultiDetek2 gas analyser is the best solution available. Depending on the production process, the amount of N₂ is critical and it is the reason why the analysis must be very accurate. Also, in some processes, an additional trace O₂ and trace H₂O analysis are required to ensure the purity of the additive gases and the hydrogen/methane.

CHEMICAL VAPOR DEPOSITION

Chemical vapor deposition is a method by which diamond can be grown from a hydrocarbon gas mixture. Since the early 1980s, this method has been the subject of intensive worldwide research. Whereas the mass-production of high-quality diamond crystals make the HPHT process the more suitable choice for industrial applications, the flexibility and simplicity of CVD setups explain the popularity of CVD growth in laboratory research. The advantages of CVD diamond growth include the ability to grow diamond over large areas and on various substrates, and the fine control over the chemical impurities and thus properties of the diamond produced. Unlike HPHT, CVD process does not require high pressures, as the growth typically occurs at pressures under 27 kPa.

The CVD growth involves substrate preparation, feeding varying amounts of gases into a chamber and energizing them. The substrate preparation includes choosing an appropriate material and its crystallographic orientation; cleaning it, often with a diamond powder to abrade a non-diamond substrate; and optimizing the substrate temperature (about 800 °C) during the growth through a series of test runs. The gases always include a carbon source, typically methane, and hydrogen with a typical ratio of 1:99. Hydrogen is essential because it selectively etches off non-diamond carbon. The gases are ionized into chemically active radicals in the growth chamber using microwave power, a hot filament, an arc discharge, a welding torch, a laser, an electron beam, or other means.

ANALYSIS SOLUTION FOR DIAMOND PRODUCTION USING CVD TECHNOLOGY

Diamond production diagram

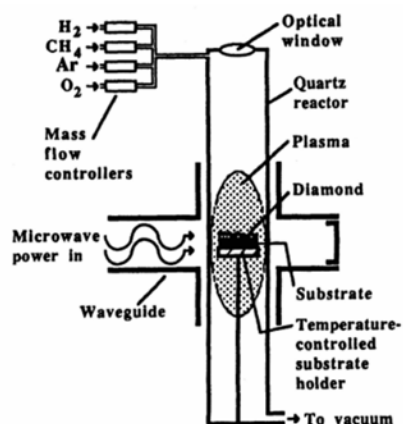

Trace impurities analysis solution



Trace N₂ from sub ppb to few hundreds' ppm is measured with the PlasmaDetek2 detector mounted in the MultiDetek2 analyzer. Optional H₂O-NH₃ and O₂ analysis can be added in the same instrument when required by the process.

LDGSS stream selector system ensures the automatic switching sequence for analysis between H₂/CH₄ and the different additive gases. LDGDSA automatic dilution system can be added to accurately calibrate in ppb's.

Figure shows a microwave plasma reactor in which diamond is grown on a silicon substrate. A gas mixture that is typically 99 volume percent hydrogen and 1 percent methane, often with additives such as oxygen and argon, is passed through a quartz tube inside a microwave waveguide. The microwave radiation partially dissociates the gas into a plasma containing hydrogen atoms, methyl radicals (CH₃), high energy electrons [8] and other reactive species such as hydroxyl radicals (OH).

Diamond crystallites nucleate on the substrate and grow into a continuous polycrystalline mass. The outer diamond growth surface is rough, but the film face next to the substrate is as smooth as the original silicon surface. High quality Type 2a diamond with a thickness greater than 1 mm can be grown over areas greater than 100 cm² with growth rates of approximately 0.1 mm/h by this technique.

HOW IS THE MULTIDETEK2 INSTRUMENT CONFIGURED

Channel 1: N₂ (O₂-NH₃ optional)

IMPURITIES	RANGE (ppm)	LDL (ppb)	REPEATABILITY (%)	Detector
N ₂	0-100	0.5	0.1	PED
O ₂	0-100	10.0	0.5	PED

The first channel is configured with a PED, using Helium or Argon as carrier gas depending of the preference of the user. The plasma detector is mounted with a selective optical filter for measuring N₂ and another filter for measuring O₂. These two impurities can then be measured without to get affected by the background gas or other interference gas molecules. The sample is simply injected through a molecular sieve column and the O₂-N₂ impurities are measured by the plasma emission detector. Using this method, the impurities can be measured from low ppb up to ppm in the required gas mixtures containing He/Ar/H₂/CH₄.

The same plasma emission detector (PED) can also be used for measuring the ppb/ppm trace ammonia (NH₃) in the different gas mixtures. A separate chromatographic flow path using the appropriacy capillary columns will be used.

Channel 2: H₂O

IMPURITIES	RANGE (ppm)	LDL (ppb)	REPEATABILITY (%)	Detector
H ₂ O	0-10	10.0	0.5	Quartz crystal

The second channel is mounted with a quartz crystal sensor capable to measure trace moisture from ppb to ppm in continuous. The sample gas is regulated with its mass flow controller and measured by the sensor. The MultiDetek2 GC has its built in moisture permeation span calibration device that allow to periodically validate the quartz crystal sensor.

RESULTS

Chromatograms : Channel 1

Sample : 5000ppb N2 Balance H2

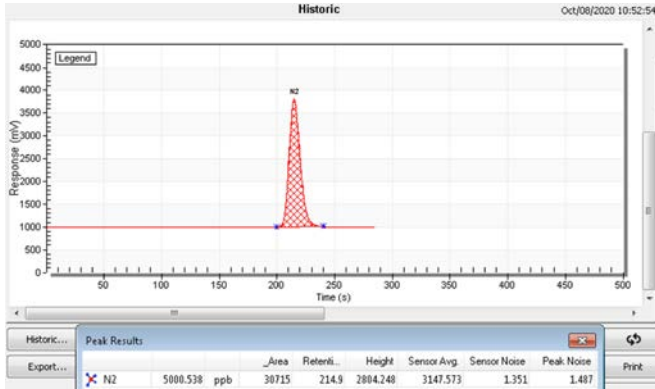

Sample : 1000ppb N2 Balance H2

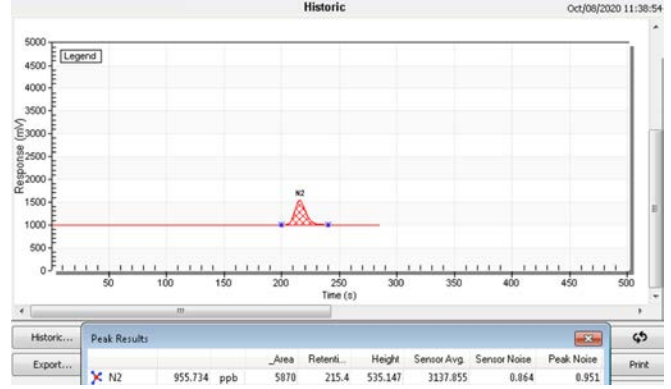

Sample : 100ppb N2 Balance H2

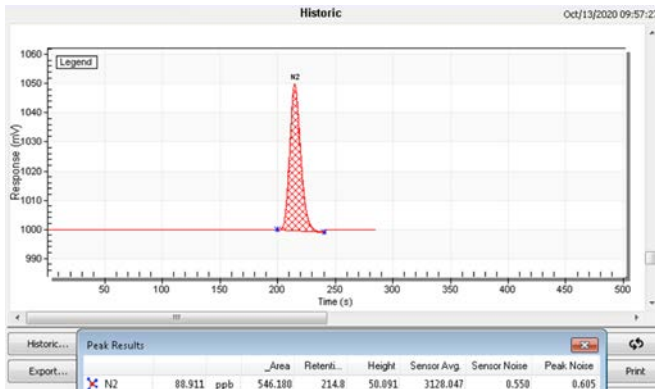

Sample : 8ppb N2 Balance H2

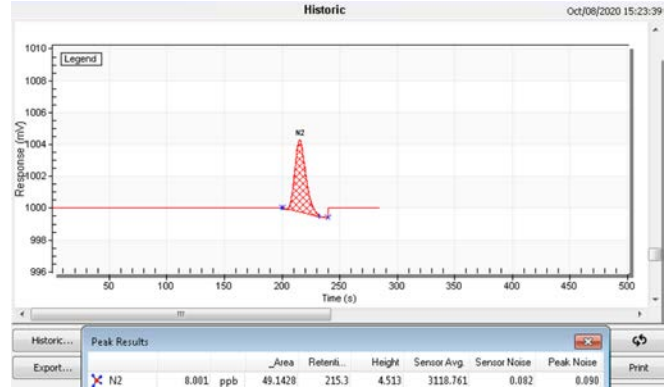

Sample : 1.5ppb N2 Balance H2

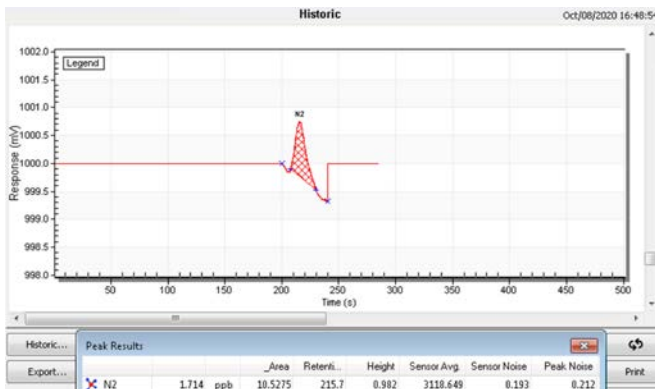

Sample : blank for noise analysis

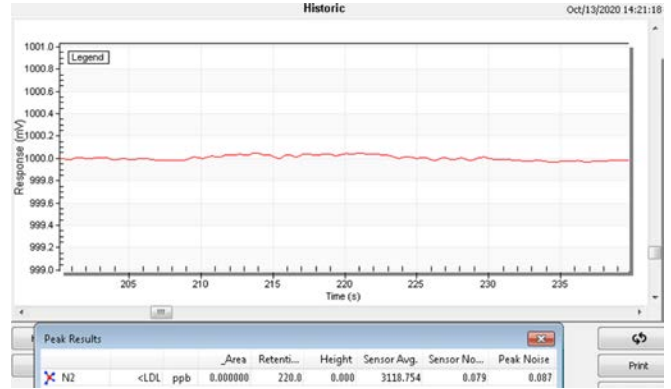

3.0 APPLICATION NOTES

LDL

COMPONENT	CONCENTRATION (ppb)	PEAK HEIGHT (mV)	NOISE (mV)	LDL (3X NOISE) (ppb)
N ₂ (Nitrogen)	8	4.51	0.087	0.46

Note: other LDL could be obtained with different injection volume and chromatographic condition

REPEATABILITY

Sample : 1.5ppb N2 Balance H2

	Description	N2
Historic		
<input type="checkbox"/> Thu, Oct-08-2020		
16:48:54		1.712
16:43:47		1.703
16:38:42		1.703
16:33:35		1.681
16:28:28		1.670
16:23:21		1.640
16:18:15		1.673
16:13:08		1.658
16:08:01		1.680
16:02:54		1.623

Sample : 100ppb N2 Balance H2

	Description	N2
Historic		
<input type="checkbox"/> Tue, Oct-13-2020		
09:57:27		88.850
09:52:20		88.893
09:47:15		88.877
09:42:09		88.819
09:37:02		88.762
09:31:56		88.831
09:26:51		88.786
09:21:45		88.760
09:16:38		88.792
09:11:31		88.850

IMPURITIES	AVERAGE (ppb)	SIGMA σ (ppb)	CV (%)	CV x 3 (%)	STATUS	REPEATABILITY (%)
N ₂	88.84	0.047	0.05	0.15	pass	0.05

Using a series of 6 consecutive analysis, the repeatability conformity test must be below 5% considering a value of 3 times the coefficient of variation (CV) to be accepted.

The repeatability % is obtained by applying the sigma of the 6 consecutive analysis on the average of these 6 same analysis.

LINEARITY

Impurity : N2

RESPONSE AREA (counts)	CONCENTRATION (ppb)
0	0
10.5	1.7
49	8
546	89
5870	955
30715	5000

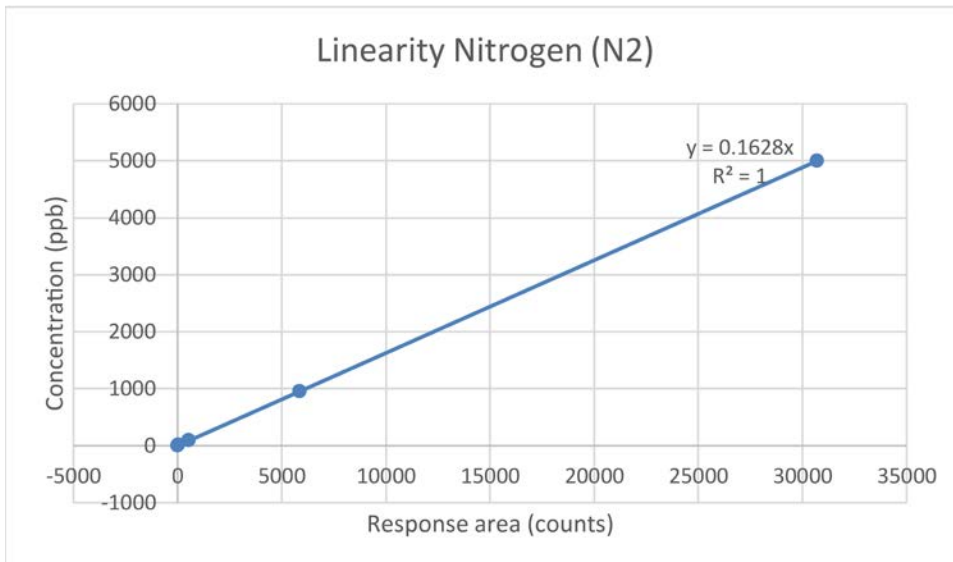

Using a series of 5 points within the measuring scale, being approximately 100%, 75%, 50%, 10%, 0% of the scale of the instrument to be measured. The points have to be generated from a certified gas bottle diluted with the same gas as the carrier gas of the instrument. The 5 points have to achieve a linear curve having its R2 at a value between 0.998 and 1.00.

CONCLUSION

The MultiDetek2 process GC configured with a plasma emission detector (PED) for measuring trace N2 impurity in the different gas matrix used for the synthetic diamond grow is perfectly suitable. The same channel can be used for measuring trace O2 as well. By adding a channel with the quartz crystal technology inside the same unit, it becomes easy to have all the measurements accomplish together. The PED sensor can also be used for tracing ammonia (NH3) all in the same analyzer. The analyzer is used with the LDGSS stream selector system, that is used to switch from the different gas streams (H2-CH4-noble gases and others). In order to calibrate the analyzer in the ppb ranges, the LDGDS-A, our dilution system can be added to the solution. All the system is integrated in the LDrack cabinet series offering a turn key solution for the diamond production industry.

APPLICATION NOTE

LD22-01



Analysis of Krypton & Xenon in UHP Oxygen



▲ MultiDetek3

▲ PlasmaDetek2
patent US 9,310,308 B2

Measuring Krypton and Xenon in Oxygen is required to produce these rare gases. Using our Multidetek3 GC with our PED, the production of Kr-Xe can be realized.

LDETEK SOLUTION

The Multidetek3 industrial gas chromatograph configured with the plasma emission detector using Argon or Helium carrier gas is used to measure any concentrations of krypton and xenon. The instrument uses two packed columns and an heartcut valve configuration to separate and measure the krypton and xenon.

The solution using Argon as carrier is preferred as it keeps the operating cost low compared to similar gas chromatograph on the market that requires Helium as carrier gas.

The instrument simply requires a light maintenance process every 5 years to replace the carrier gas purifier and the diaphragms of the chromatographic valves.

RESULTS

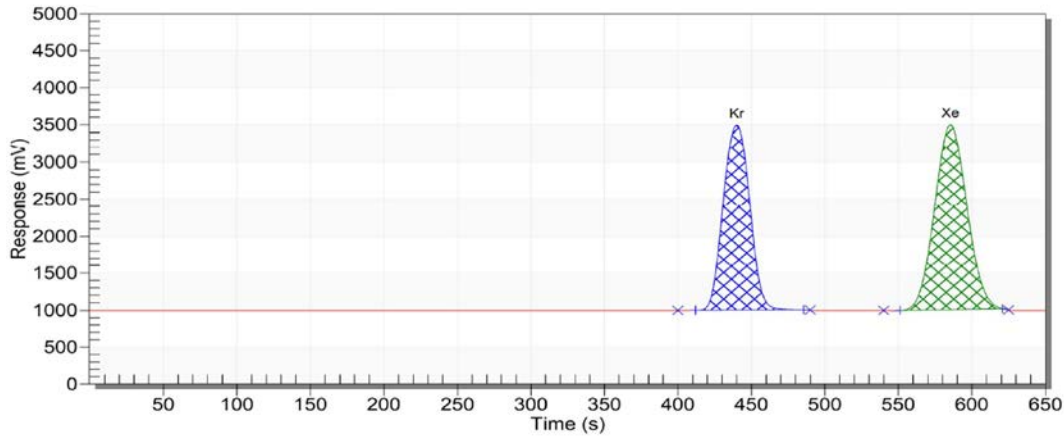

Chromatogram:
4000ppm Kr, 400ppm Xe in balance Oxygen

Limit of detection (based on 3 times the noise level from a blank)

COMPONENTS	CONCENTRATION (ppm)	PEAK HEIGHT	NOISE	LDL (3X NOISE)
Kr	4000	2500mV	0.1mV	0.48ppm
Xe	400	2500mV	0.2mV	0.01ppm

Note: other LDL could be obtained with different injection volume and chromatographic condition

CONCLUSION

The MultiDetek3 industrial gas chromatograph configured with PED using Argon or Helium as carrier gas can measure concentrations of Krypton and Xenon in Oxygen. The production of rare gases can be done with the robust MultiDetek3 instrument. Argon as carrier gas, allows the gas producers to keep its operating cost low compared to other gas chromatographs that require to use Helium as carrier gas.

APPLICATION NOTE

LD23-01



Analysis of trace impurities in UHP Helium



Helium is one of the basic chemical elements. In its natural state, helium is a colorless gas known for its low density and low chemical reactivity. It is probably best known as a non-flammable substitute for hydrogen to provide the lift in blimps and balloons. Because it is chemically inert, it is also used as a gas shield in robotic arc welding and as a non-reactive atmosphere for growing silicon and germanium crystals used to make electronic semiconductor devices. Liquid helium is often used to provide the extremely low temperatures required in certain medical and scientific applications, including super conduction research.

Helium is usually produced as a by-product of natural gas processing. Natural gas contains methane and other hydrocarbons, which are the principal sources of heat energy when natural gas is burned. Most natural gas deposits also contain smaller quantities of nitrogen, water vapor, carbon dioxide, helium, and other non-combustible materials, which lower the potential heat energy of the gas. To produce natural gas with an acceptable level of heat energy, these impurities must be removed. This process is called upgrading. There are several methods used to upgrade natural gas. When the gas contains more than about 0.4% helium by volume, a cryogenic distillation method is often used in order to recover the helium content. Once the helium has been separated from the natural gas, it undergoes further refining to bring it to 99.99+% purity for commercial use. During the helium purification process, a gas analyser system for the trace impurities analysis is required to control the process and to qualify the helium purity before using it.

LDETEK SOLUTION

The Multidetek3 industrial gas chromatograph has been configured here with the plasma emission detector using Helium as carrier gas. The unit is constructed here using multiple channels to allow the simultaneous analysis of trace impurities Ar+O₂-N₂-Ne-H₂-CH₄-CO₂-CO in balance pure Helium. The analysis is performed in a time frame of +/- 15 minutes for all impurities. The analysis time can be reduced if required by adding an extra channel to isolate CO₂ and CO impurities with independent columns to accelerate their retention times.

Additional optional modules possible to install in the same instrument:

- The analysis of impurity NMHC can be added using the same PED with an extra backflush to detector valve/column module.
- The separation of Ar-O₂ can be done by adding an ArgoTek column module within the same instrument.
- A quartz crystal sensor/module can be mounted in the same instrument to allow the analysis of trace moisture down to 10ppb ldl.

The MultiDetek3 helium purity analysis system here has been configured with a range of 0-10ppm and a ldl at 5-10ppb. Other configurations are possible on request.

RESULTS

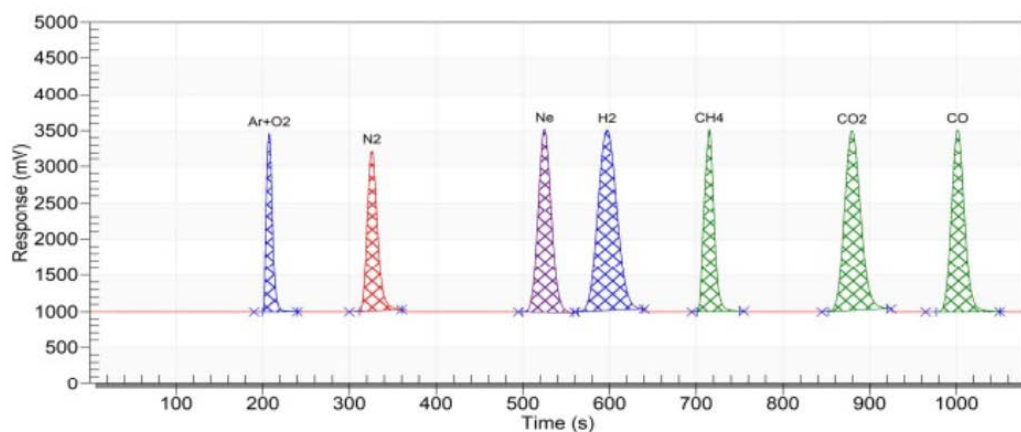

Chromatogram (Span calibration) of trace impurities Ar+O₂-N₂-Ne-H₂-CH₄-CO₂-CO in balance gas Helium

Peak	Unit	Calibration Value	_Area Counts
Ar+O ₂	ppm	12.000	18856
N ₂	ppm	12.200	26165
Ne	ppm	10.700	44546
H ₂	ppm	12.200	60413
CH ₄	ppm	12.700	30129
CO ₂	ppm	12.400	48965
CO	ppm	12.700	39694

Limit of detection (based on 3 times the noise level from a blank)

COMPONENTS	CONCENTRATION (ppb)	PEAK HEIGHT	NOISE	LDL (3X NOISE)
Ar+O2	105	27mV	0.28mV	3ppb
N2	713	144mV	0.28mV	4ppb
Ne	135	29mV	0.14mV	2ppb
H2	80	19mV	0.28mV	3ppb
CH4	216	67mV	0.28mV	3ppb
CO2	98	20mV	0.42mV	6ppb
CO	83	17mV	0.42mV	6ppb

Note: other LDL could be obtained with different injection volume and chromatographic condition.

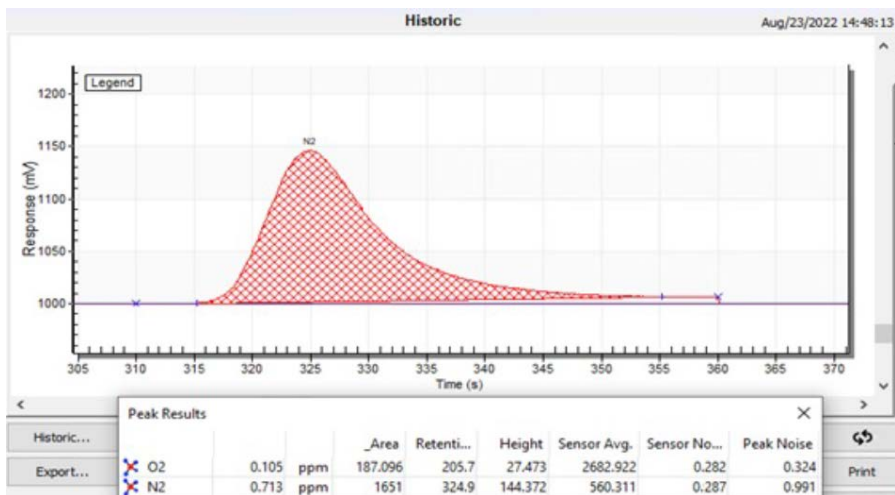
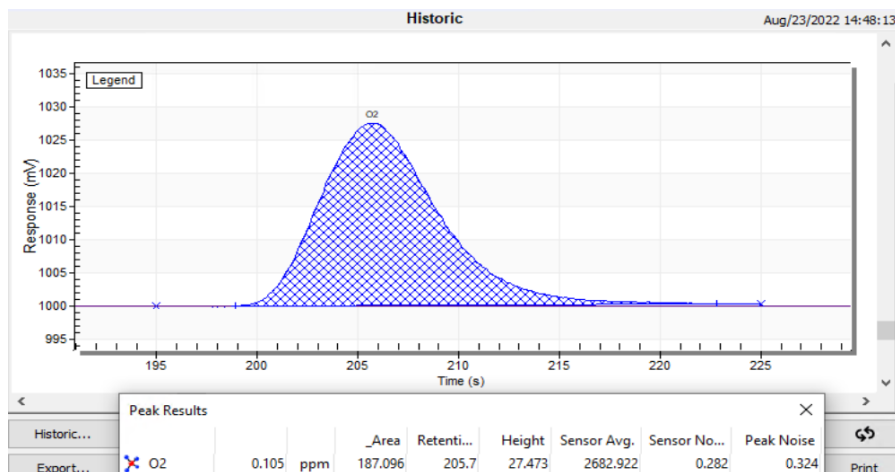

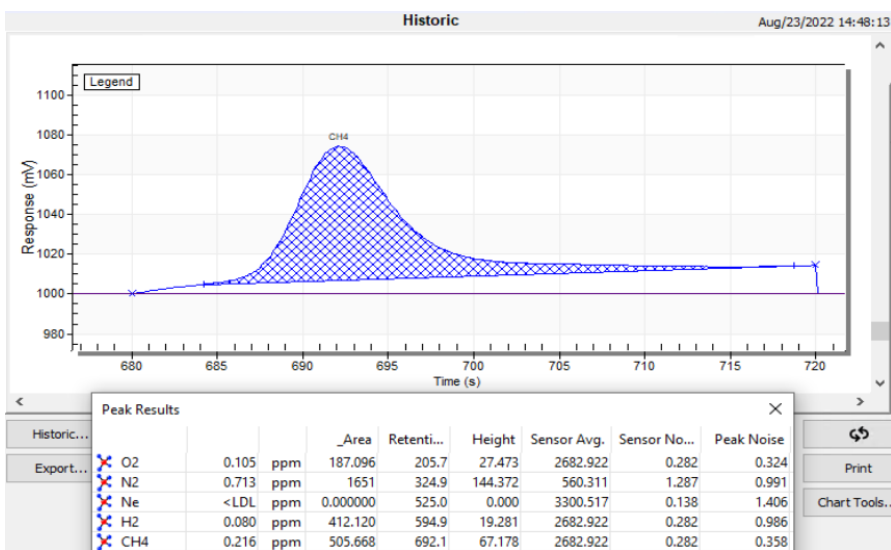
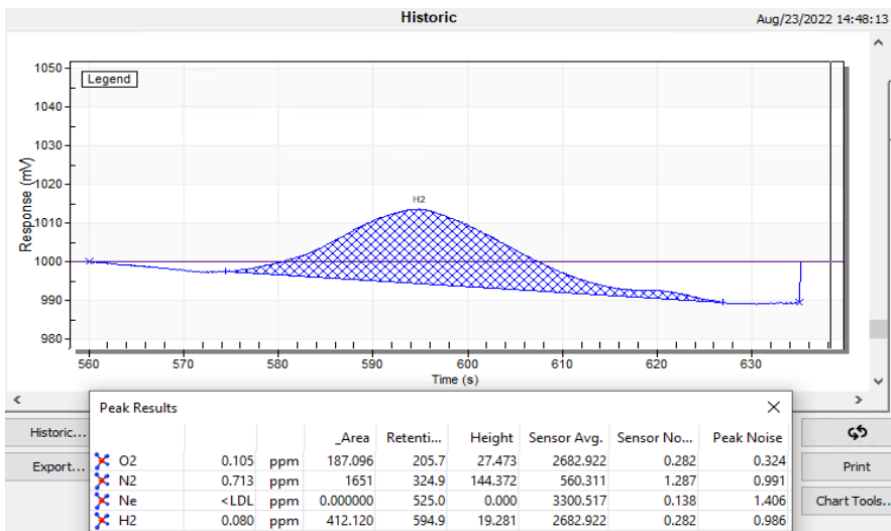
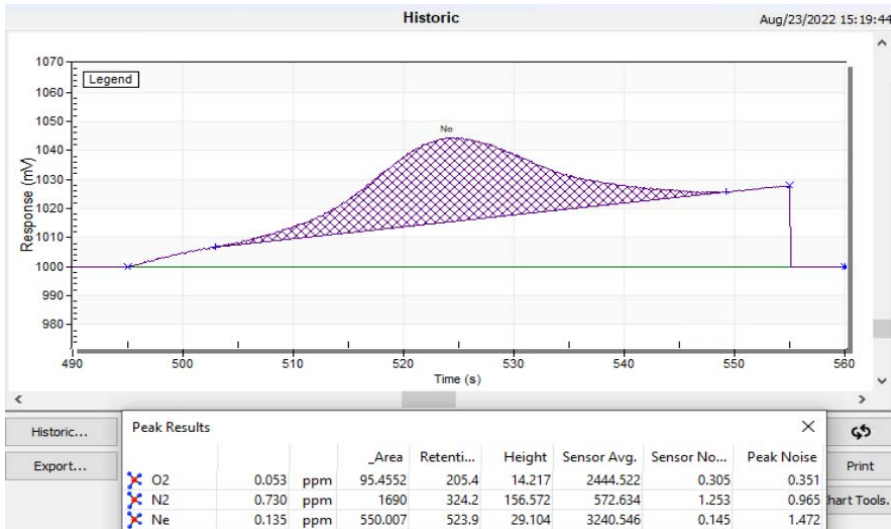

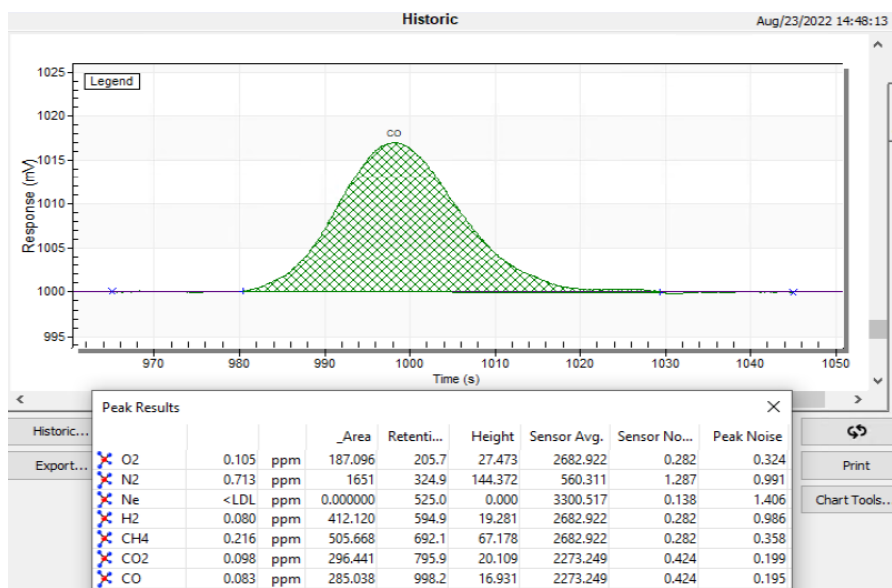
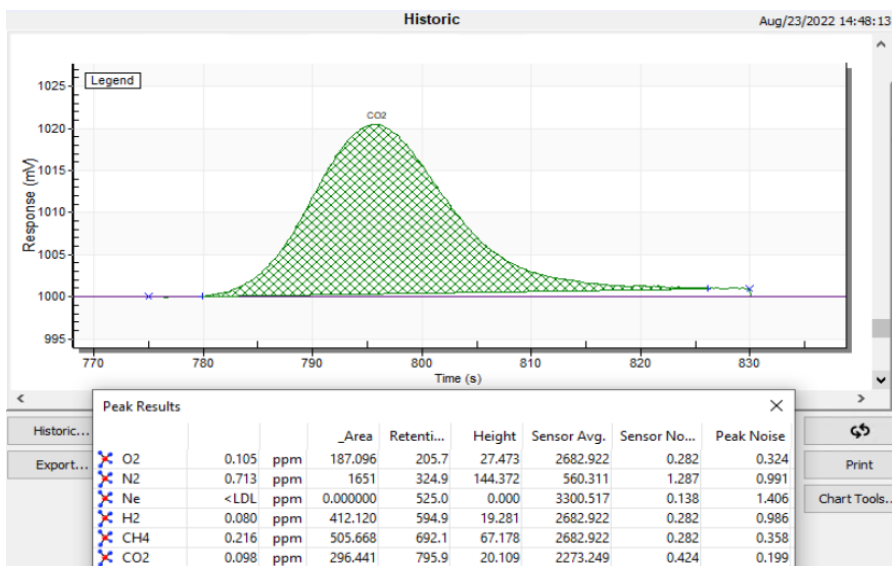

Repeatability: Based on the GC standards. Using 6 of 10 consecutive runs, being lower than 5% of 3*CV%

CONCLUSION

The MultiDetek3 configured with PED and Helium carrier gas can measure all trace impurities in one instrument. The system offers the performances required by the industries for stability/repeatability/limit of detection and linearity. Its modular construction allows to build the unit upon your analytical requirements. The MD3 gas analyzer offers a complete analytical solution for the certification of UHP helium production within a robust system. Ask our experts for more details about all our accessories that come with such analytical device.

APPLICATION NOTE

LD23-03



Analysis of trace impurities in UHP Krypton

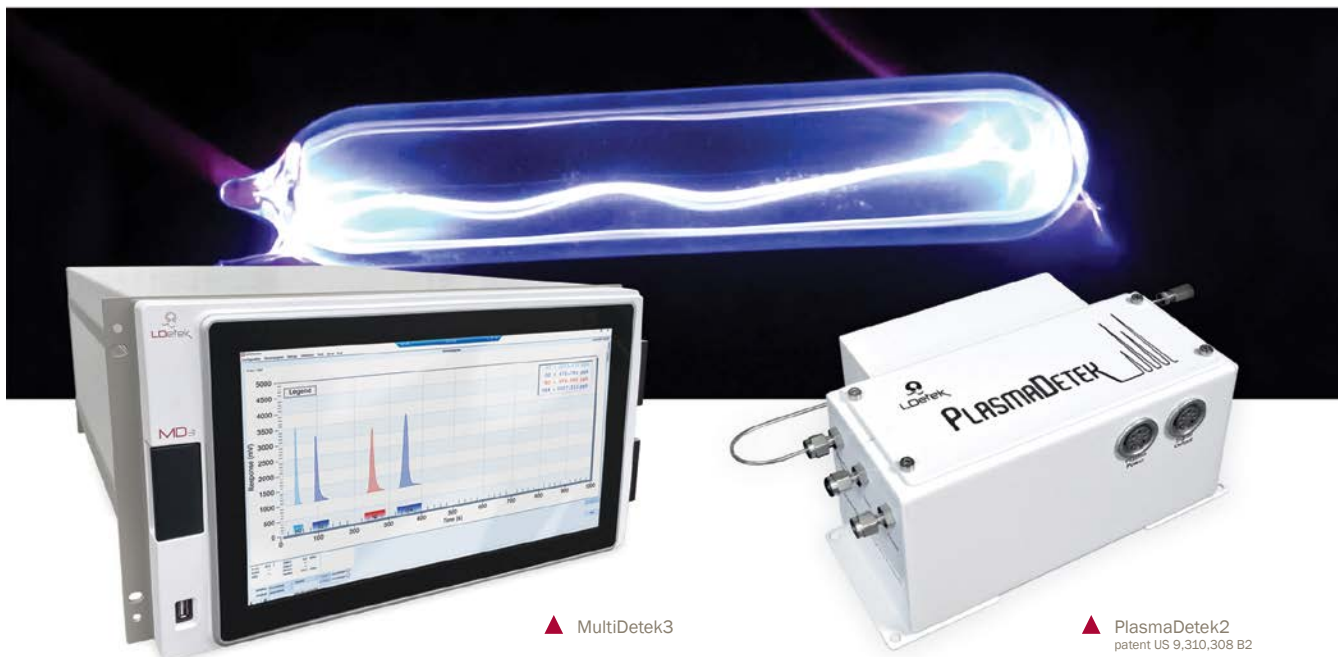

3.0 APPLICATION NOTES

The krypton is one of the most valuable gas as it is produced from fractional distillation of liquefied air. Considering only 1ppm Krypton is presents in ambient air, it becomes a costly process to produce pure krypton.

In the forecast period of 2022-2027, the global krypton gas market is expected to grow at a CAGR of 6%. As per the analysis by Expert Market Research, the market is expected to be driven by the rising demand of oxygen, since the need for ventilators has rapidly increased in the wake of the COVID-19 pandemic.

The drastic impact of the pandemic has taken the world by storm and governments and hospitals are anticipating the situation to only get worse in the coming months. These institutions are stocking up the necessary inventory to prevent shortage, which is boosting the krypton gas market significantly. The increase in research and development activities (R&D) in the production of krypton gas has given rise to various technologies of production, thereby bolstering the market growth.

Krypton is used with argon in fluorescent lights to improve their brightness and with nitrogen in incandescent lights to extend their lifetime. It is also used in flashbulbs to produce a very bright light for a very short period of time, for use in high-speed photography.

LDETEK SOLUTION

The purity Krypton can be qualified with the use of the MultiDetek3 gas chromatograph configured with PED. Due to the small presence of about 1ppm krypton in air used as raw material to produce UHP krypton, it is usually required to measure multiple impurities for the validation of krypton purity. The MultiDetek3 here has been configured with PED module with helium carrier gas to measure ppb/ppm trace impurities of H₂-O₂-N₂-CH₄-CO-Xe-CF₄-C₂F₆ in pure krypton.

The unit has been configured with measuring range of 0-10ppm and ldl of 5-10ppb for impurities H₂-O₂-N₂-CH₄-CO-Xe. The other impurities CF₄ and C₂F₆ use a range of 0-500ppm with an ldl of 25ppb.

Other configurations and ranges/ldls are possible. The parameters mostly depends of the site production requirements and process.

RESULTS

Chromatograms (Span calibration) of trace impurities H₂-O₂-N₂-CH₄-CO-Xe-CF₄-C₂F₆ in balance gas Krypton

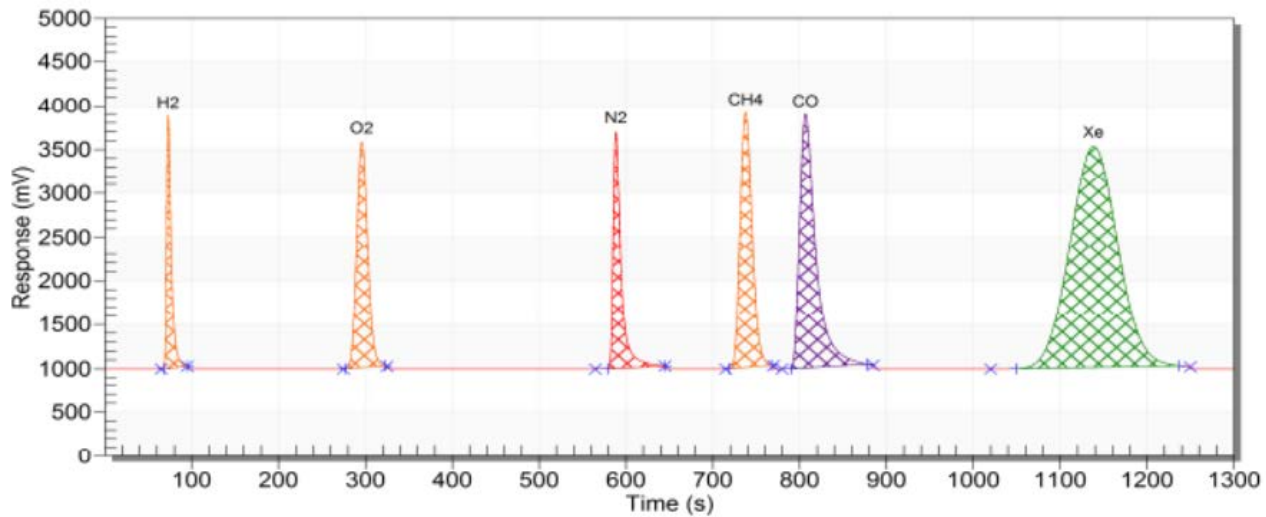

Peak	Unit	Calibration Value	_Area Counts
H ₂	ppm	9.50	18135
O ₂	ppm	8.50	36798
N ₂	ppm	9.10	28493
CH ₄	ppm	9.80	47016
CO	ppm	9.50	62590
Xe	ppm	10.00	161004

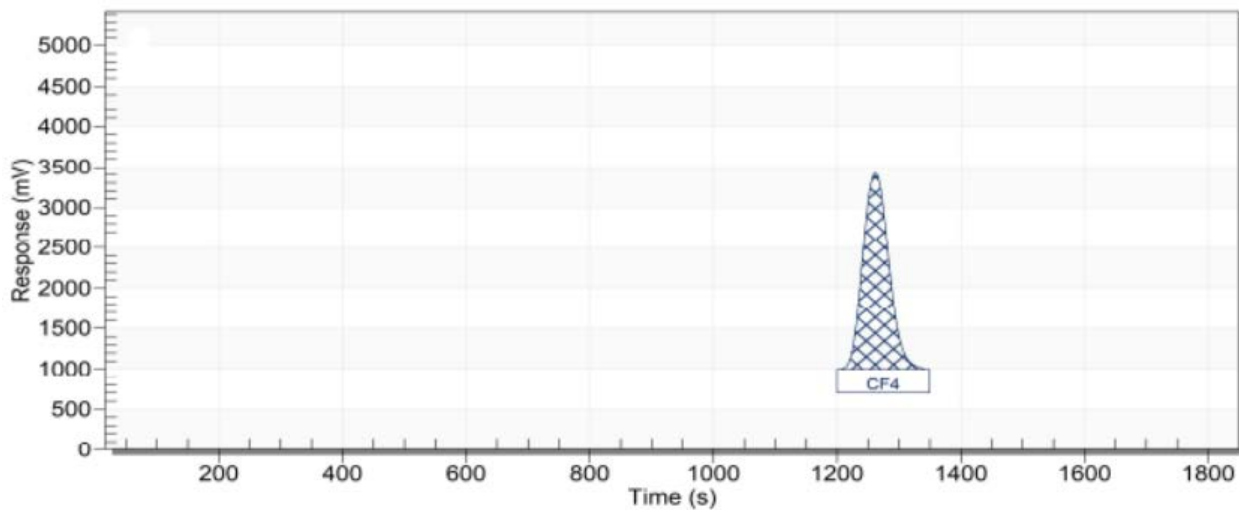

Peak	Unit	Calibration Value	_Area Counts
CF4	ppm	397.00	20608

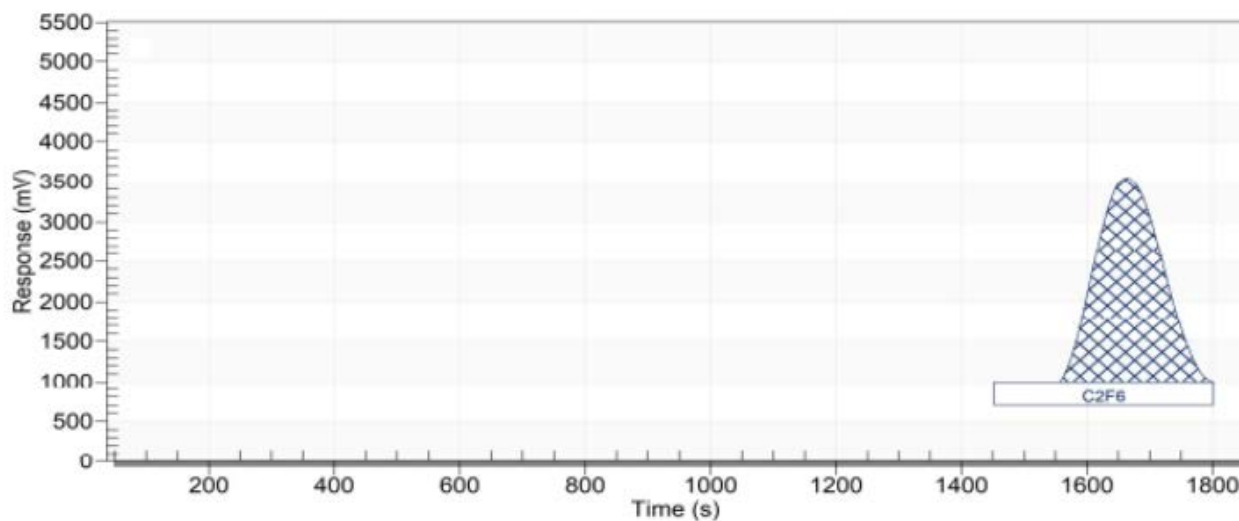

Peak	Unit	Calibration Value	_Area Counts
C2F6	ppm	100.00	73418

Limit of detection (based on 3 times the noise level from a blank)

COMPONENTS	CONCENTRATION (ppb)	PEAK HEIGHT	NOISE	LDL (3X NOISE)
H2	9.5	2988mV	0.53mV	5ppb
O2	8.5	2678mV	0.46mV	4ppb
N2	9.1	2852mV	0.71mV	7ppb
CH4	9.8	3026mV	0.69mV	7ppb
CO	9.5	2918mV	0.68mV	6ppb
Xe	10.0	2578mV	0.36mV	7ppb
CF4	397	2452mV	0.05mV	24ppb
C2F6	100	2526mV	0.17mV	20ppb

Note: other LDL could be obtained with different injection volume and chromatographic condition.

Repeatability: Based on the GC standards. Using 6 of 10 consecutive runs, being lower than 5% of 3*CV%

Linearity: Based on the GC standards. A linear curve having its R2 at a value between 0.998 and 1.00.

Accuracy: Based on the GC standards. $\leq 1\%$ of error or $|d|$ whichever is higher

CONCLUSION

The MultiDetek3 configured with PED can offers a good analytical solution for trace ppb/ppm impurities for quality and validation of UHP Krypton. The gas chromatograph is configured with standard industrial communication protocols and remote-control interface. The platform is modular to adapt any of additional requirement in terms of purity Kr production. The MultiDetek3 is a very robust gas analyzer configured for industrial market to run 24/7.

APPLICATION NOTE

LD23-04

Analysis of trace impurities in UHP Argon



▲ MultiDetek3

▲ PlasmaDetek2
patent US 9,310,308 B2

The Argon has many commercial and industrial usages. To name just a few, it is used as shield gas in welding and as an inert gas to prevent oxidation in heat treatment processes for metal/titanium production and 3D printing.

Argon is industrially extracted from liquid air in a cryogenic air separation unit by means of fractional distillation.

LDETEK SOLUTION

Measuring trace ppb/ppm impurities in UHP Argon with the MultiDetek3 gas chromatograph using an Argon PED carrier gas makes the best analytical instrument capable of measuring all impurities in one online analyzer. The argon carrier makes the analyser operating cost low while the performances stays excellent.

The unit has been configured with measuring range of 0-50ppm and Idl of 25-50 ppb for impurities H2-O2-N2-CH4-CO-CO2.

Other configurations and ranges/Idls are possible. The parameters mostly depend of the site production requirements and process.

RESULTS

Chromatograms (Span calibration) of trace impurities H₂-O₂-N₂-CH₄-CO-CO₂ in balance gas Argon

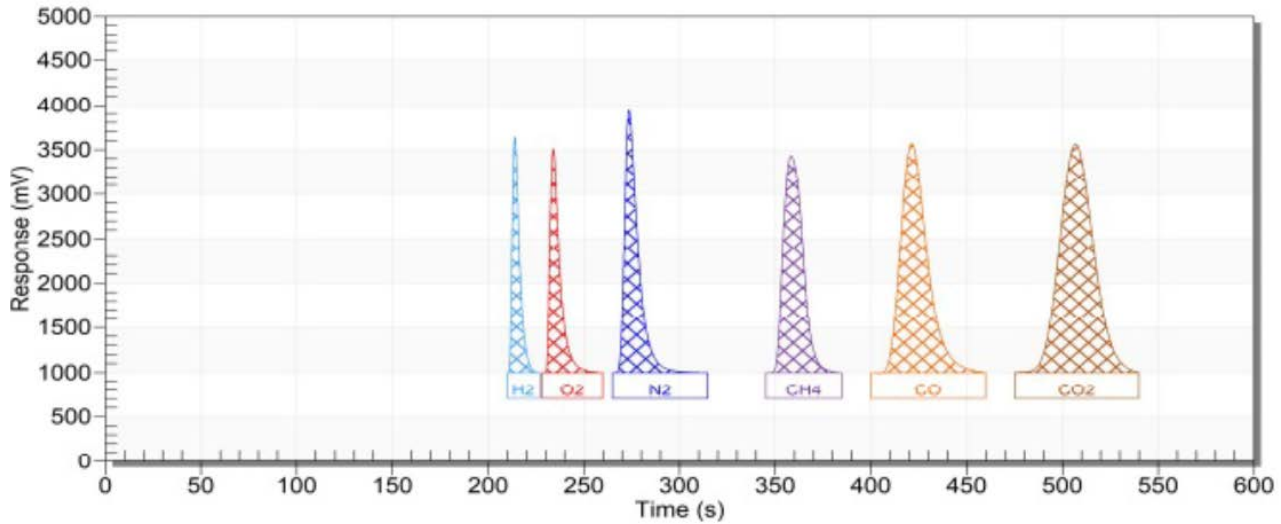

Peak	Unit	Calibration Value	_Area Counts
H ₂	ppm	52.52	1831
O ₂	ppm	49.50	11831
N ₂	ppm	104.00	28684
CH ₄	ppm	47.72	5485
CO	ppm	50.59	6762
CO ₂	ppm	51.19	11477

Limit of detection (based on 3 times the noise level from a blank)

COMPONENTS	CONCENTRATION (ppb)	PEAK HEIGHT	NOISE	LDL (3X NOISE)
H ₂	0.8	44mV	0.43mV	23ppb
O ₂	0.8	42mV	0.46mV	26ppb
N ₂	0.8	24mV	0.21mV	21ppb
CH ₄	0.7	36mV	0.39mV	23ppb
CO	51.3	2601mV	0.76mV	45ppb
CO ₂	51.2	2557mV	0.56mV	34ppb

Note: other LDL could be obtained with different injection volume and chromatographic condition.

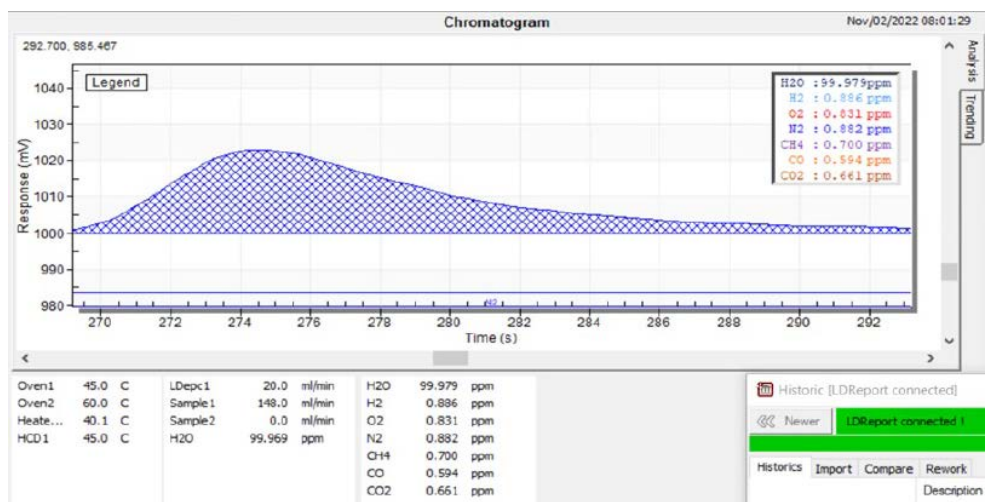
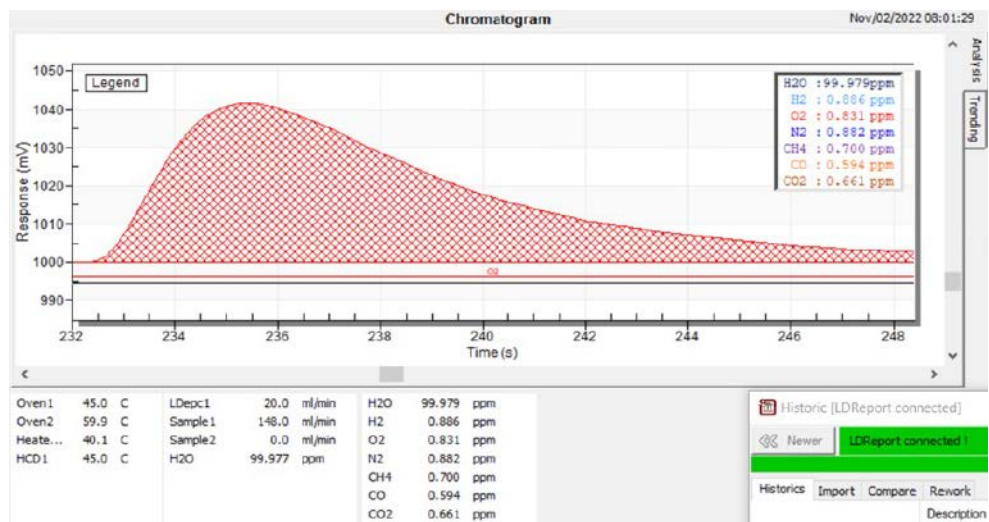
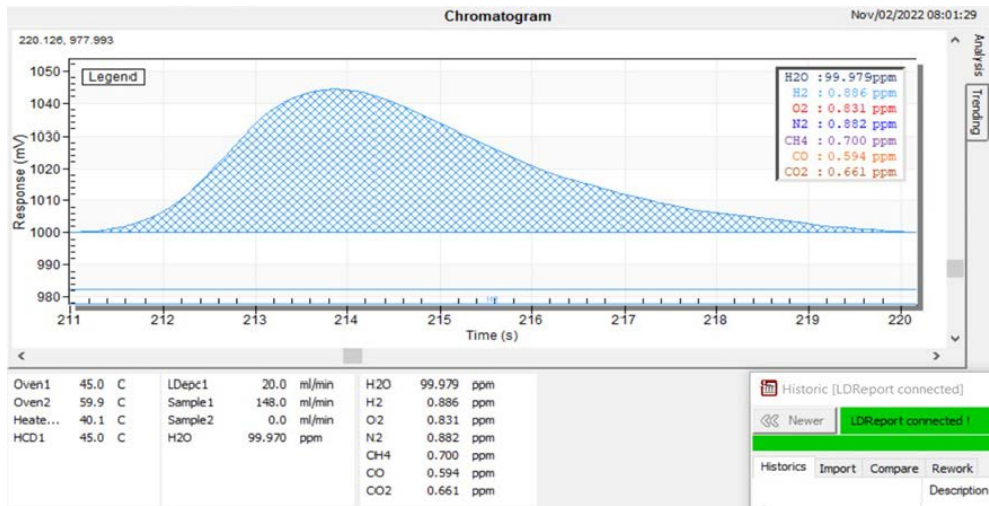

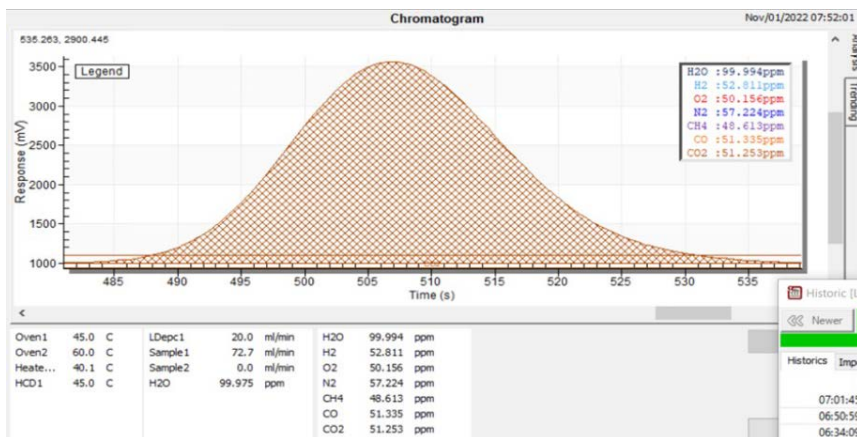
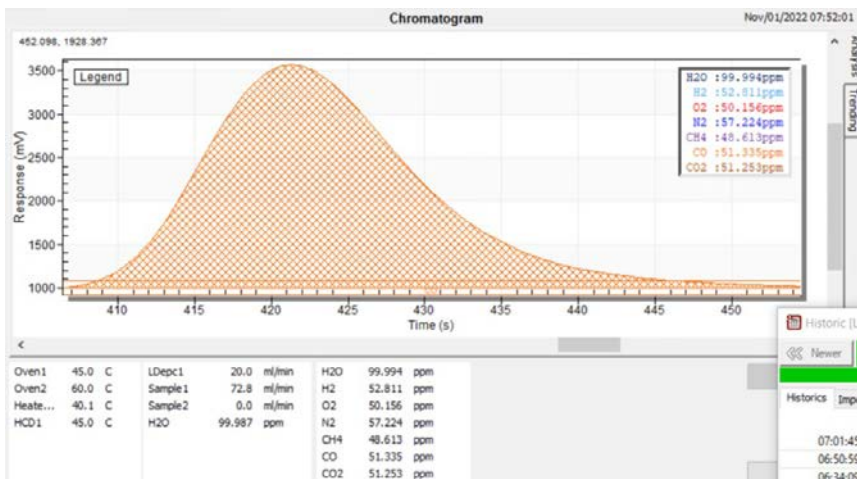
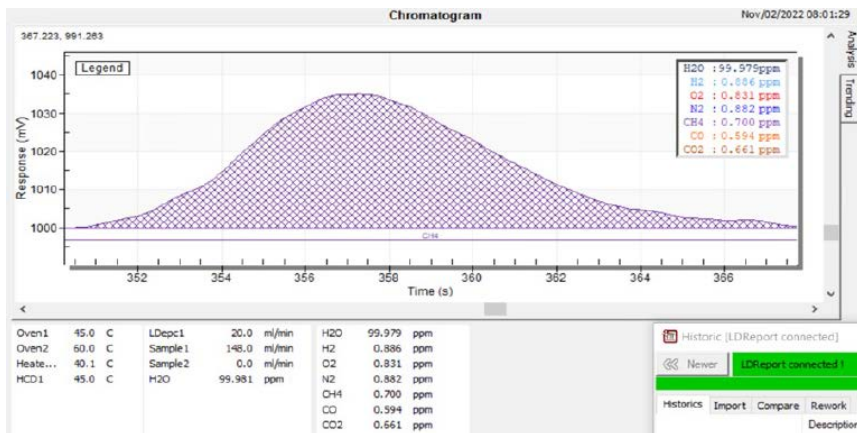

Repeatability: Based on the GC standards. Using 6 of 10 consecutive runs, being lower than 5% of 3*CV%

Linearity: Based on the GC standards. A linear curve having its R2 at a value between 0.998 and 1.00.

Accuracy: Based on the GC standards. <= 1% of error or |d| whichever is higher

CONCLUSION

The MultiDetek3 configured with an Argon PED offers a good analytical solution for trace ppb/ppm impurities for quality and validation of UHP Argon. The gas chromatograph is configured with standard industrial communication protocols and remote-control interface. The platform is modular to adapt any of additional requirement in terms of UHP Argon production. The MultiDetek3 is a very robust gas analyzer configured for industrial market to run 24/7.



3.0 APPLICATION NOTE

3.3 PETROCHEMICAL



APPLICATION NOTE

LD12-08



Analysis of Sulfurs with the PlasmaDetek

The analysis of sulfurs can now be performed using the PlasmaDetek technology. With its sulfurs selective mode, the analysis of low ppb sulfurs can be easily quantified.

PLASMADETEK CONFIGURATION:

The PlasmaDetek is configured with one output signal to be selective to sulfurs.



Figure 1: PlasmaDetek detector

This is a stand-alone detector system that requires only **argon or helium** as carrier gas to make the measurement. No need of doping gas or other devices to make it selective to sulfurs.

CHROMATOGRAPHY CONFIGURATION:

The detector can be used with different configurations to run the sulfurs analysis. As example, the H₂S and CO₂ analysis in balance nitrogen has been tested using a 2 meter RT-XLSulfur column from Restek with a backflush to detector configuration using a 10 ports diaphragm valve. The carrier flow rate has been adjusted to 5sccm using helium (**Argon can also be used as carrier gas to reduce operational cost**).

The diaphragm valve is first set to "position on" to allow the sample injection through the chromatographic column. Most of the nitrogen and/or air are then vented out of the system. The valve position is hold to "position on" until the major parts of the nitrogen and/or air have been vented out. The valve is then set to "position off" just before the hydrogen sulfide elution time to avoid venting it out. The sulfurs impurities then flow back through the 2 meter RT-XLSulfur and goes one by one to the PlasmaDetek for analysis.

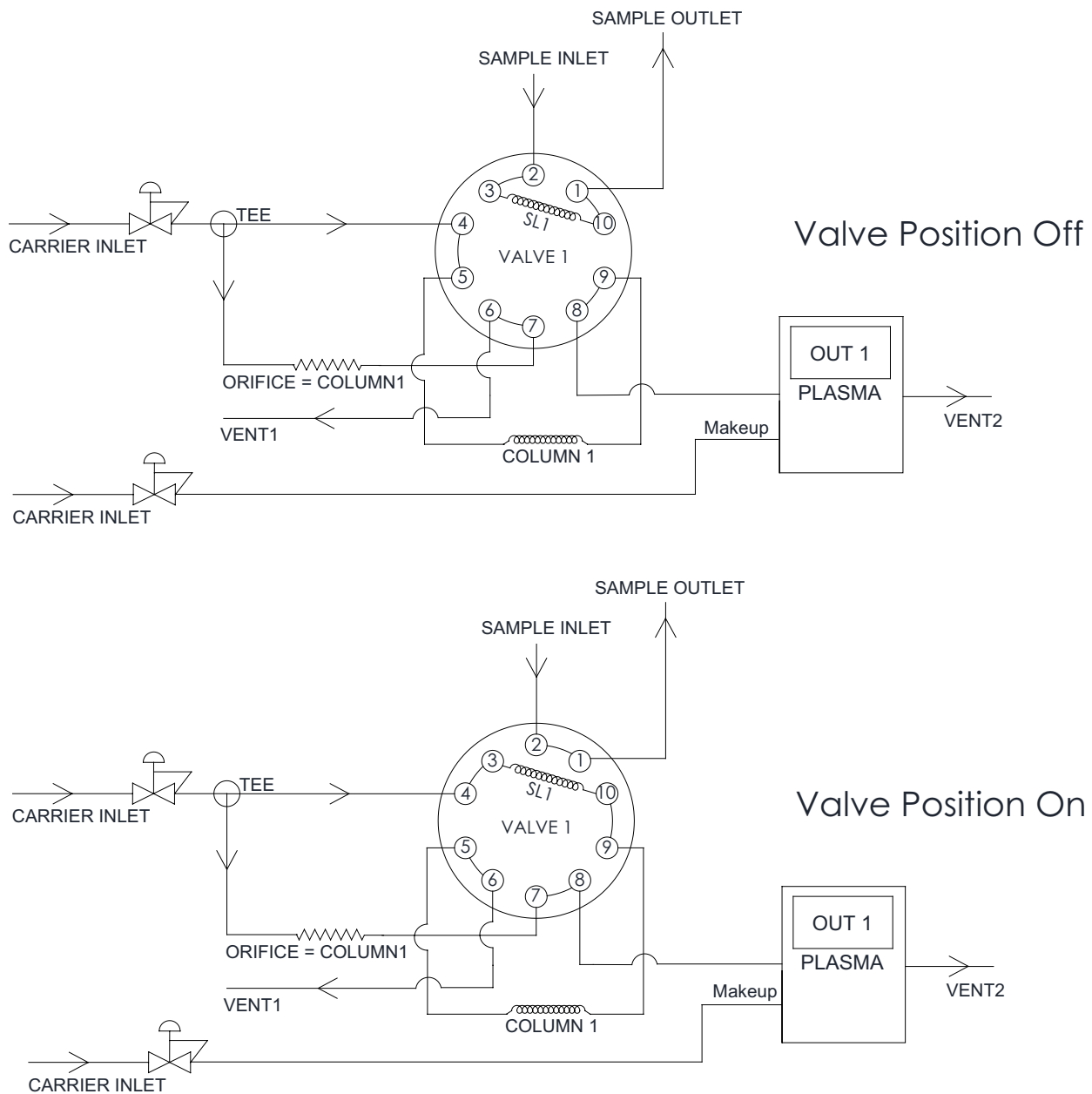

- One PlasmaDetek selective to sulfurs
- Helium carrier gas: 5 cc/min
- 1 x 10 ports diaphragm valve
- 1 x 2 meters RT-XLSulfur micro packed column
- 1 x sampling loop: 250 μ l

Figure 2: Plumbing configuration for analysis of H₂S & COS in balance Nitrogen

RESULTS AND PERFORMANCE:

Figure 3 shows a chromatogram run with this configuration with a sample containing ppm H₂S and COS in a nitrogen balance. The chromatogram demonstrates the high sensitivity and selectivity to sulfurs in comparison with pure nitrogen.

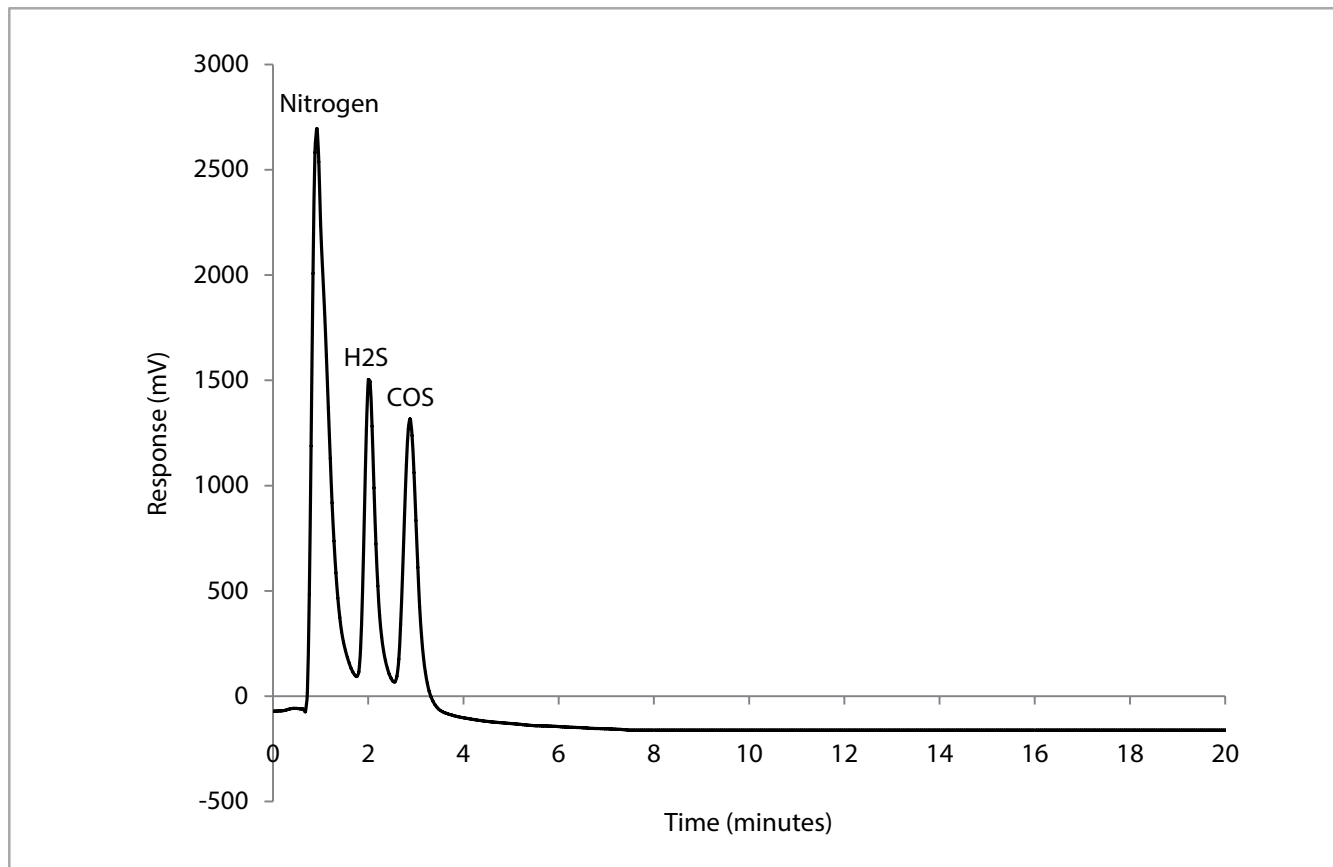

Figure 3: Mixture 10ppm H₂S, 9ppm COS in balance Nitrogen

Figure 4 shows the performance of the PlasmaDetek system obtained with the configuration described above. The results demonstrate the high level of sensitivity to sulfurs.

COMPONENT	CONCENTRATION	PEAK HEIGHT	NOISE	S/N	LOD (ppb) S/N = 3	LOQ (ppb) S/N = 5
Hydrogen sulfide	10 ppm	1410 mV	0.054 mV	26111	1.10	1.9
Carbonyl sulfide	9 ppm	1302 mV	0.054 mV	24111	1.11	1.8

Figure 4: LOQ and LOD calculation

APPLICATIONS:

The PlasmaDetek can be easily installed in any laboratory, industrial or portable gas chromatography system. For the sulfurs analysis, the use of a portable unit is often required since the GC system needs to be moved at different locations. The ability of the PlasmaDetek to offer a quick purging and stabilization makes it ideal for portable unit like demonstrated on figure 5.



Figure 5: PlasmaDetek installed in a portable unit

CONCLUSION:

Using the PlasmaDetek, the analysis of sulfurs can be performed with success. The possibility to use argon or helium as carrier gas gives more flexibility and allows reducing operational cost. Its ability to be very sensitive to sulfurs simplifies the chromatographic configuration. This is a cost effective and maintenance free system that offers many benefits.

APPLICATION NOTE

LD13-03



Measurement of H₂S and COS in Syngas with MultiDetek 2



▲ MultiDetek 2

Syngas (Synthesis gas) a fuel gas mixture, primarily composed of hydrogen, carbon monoxide and carbon dioxide, is mainly used as intermediate in creating synthetic natural gas (SNG) or ammonia or methanol.

To be able to use a clean and environmental friendly fuel and feedstock, the sulfurs compounds must be removed. Right analysis tool is needed to ensure that the concentration of sulfurs is kept at the minimum desired level.

LDETEK SOLUTION:

The MultiDetek 2 (MD2) along with the PlasmaDetek technology bring an ideal and cost effective solution to monitor hydrogen sulfide (H₂S) and carbonyl sulfide (COS) in syngas.

Other common technologies used on the market, like SCD (Sulfur Chemiluminescence Detector) or FPD (Flame Photometric Detector), need hydrogen and air. By using the PlasmaDetek and argon as carrier gas, the MD2 gives a low cost of operation and safer solution. All safety installation for the supply of hydrogen is avoided.



▲ PlasmaDetek

A simple frontflush configuration is used to get rid of the synthesis gas background with the first column. The sulfurs compounds are then well separated by the second column and sent to the PlasmaDetek (PED) especially configured for sulfurs gases. With the use of micro packed type columns, the system can operate with very low carrier flow consumption. The use of argon as carrier gas brings the system even more interesting cause of the low operational cost due to low cost of Argon gas.

Such MultiDetek operates with column carrier flow of 5sccm. A make up gas of 20sccm is required to the detector to allow good stability and sensitivity. No additional gases or consumables parts are required what minimize the operation and installation cost.

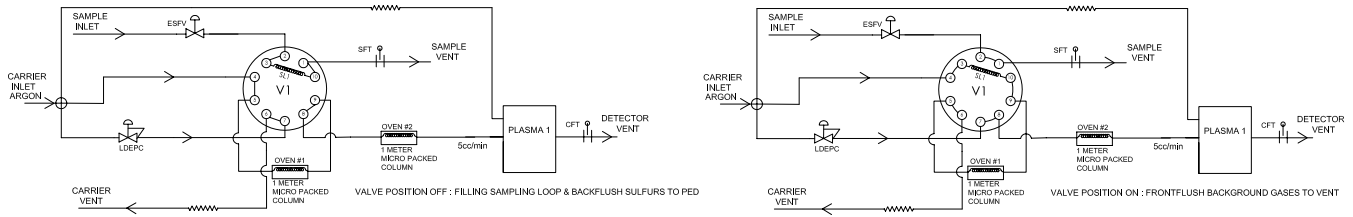

With the combination of the PlasmaDetek and argon carrier gas, detection as low as a few ppb is possible.

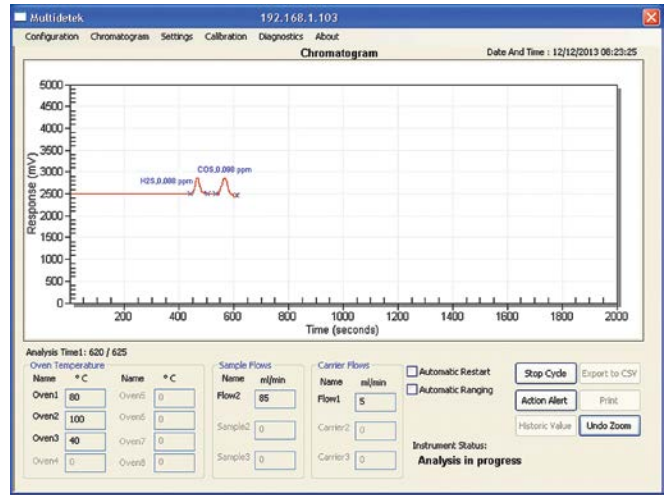
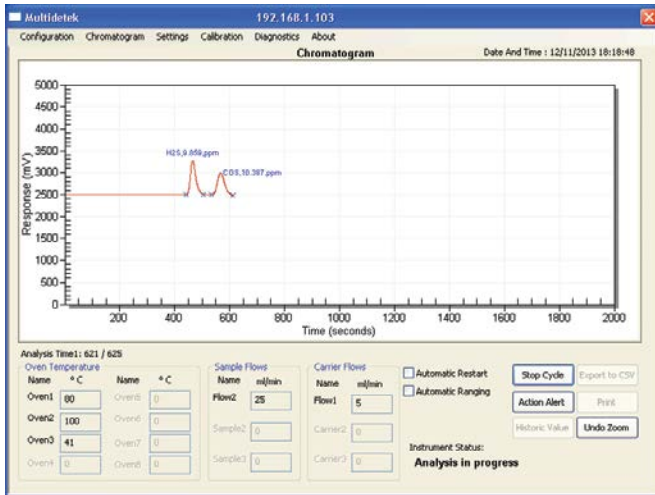

Analysis results showing stability on 19 consecutive cycles for H2S & COS at concentration of 400ppb. Then switch on span gas at 10ppm for H2S & COS, then switch on zero gas for H2S & COS.

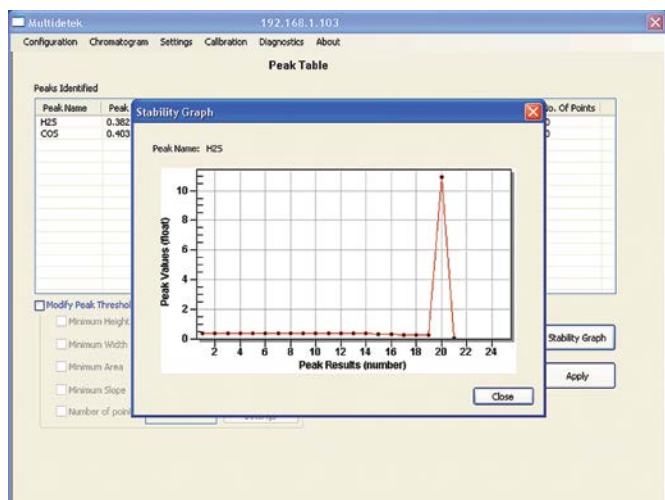
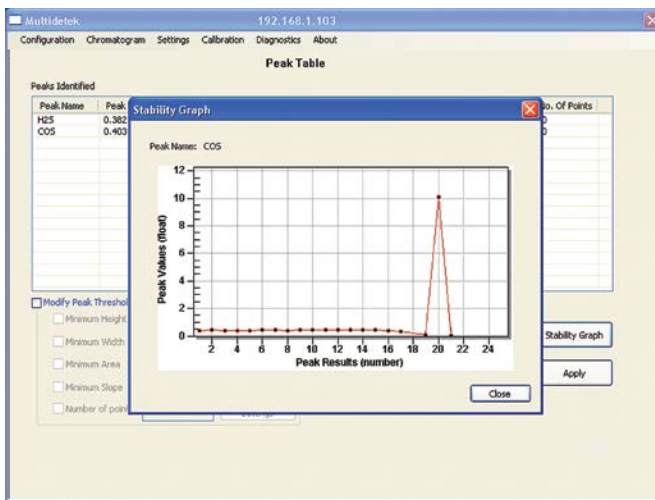

With the user friendly interface and the configuration of the MD2, it is easy to use the instrument as a process control device or simply a laboratory gas chromatograph to make sporadic analysis.

APPLICATION NOTE

LD16-05



Refinery gas analyses with MultiDetek2 compact gas chromatograph and PlasmaDetek2 gas detector



▲ MultiDetek2

▲ PlasmaDetek2

The analysis of trace permanent gases has many different fields of application in the petrochemical industry. One of the most important is for controlling the manufacturing process and the product quality. For example, some contaminants as carbon monoxide and carbon dioxide tend to deteriorate the catalysts in the propylene and ethylene polymer grade production.

An instrument for monitoring trace impurities is then required. Many different GC techniques are available on the market. Most of the techniques use a combination of TCD, FID and methanizer for the trace analysis of H₂-O₂-N₂-CH₄-CO-CO₂ in propylene and ethylene. More precisely, an FID and a methanizer are used to trace CH₄-CO and CO₂. A TCD with Hydrogen or Helium carrier gas is used to trace O₂-N₂ detection. Finally, a second TCD with Argon or Nitrogen carrier gas must be added to trace H₂ detection. These solutions require complex GC solutions with multiple detectors and multiple gas sources for carrier, fuel and air. On top of that, an FPD must be added in some cases when the trace analysis of H₂S is required.

LDETEK SOLUTION:

The MultiDetek2 compact GC solution combined with the PlasmaDetek2 (PED) can perform the analysis of low concentration H₂-O₂-N₂-CH₄-CO-CO₂ in different petrochemical gases as propylene, ethylene, propane, butylenes, butane and some others.

This solution offers the advantage of having a single detection technology based on plasma emission detector to achieve detection limits from ppb to ppm as required for this type of application. A single carrier gas source is necessary. It can be Helium or Argon depending on the availability of gases on site.

The method is configured with 2 channels merging in one PlasmaDetek2(PED). The first channel has a 10 port injection/backflush diaphragm valve with a Q Bond pre- column that allows the elution of H₂-O₂-N₂-CH₄-CO as one peak and then vent out the heavier gases. The second column is a molecular sieve used for the separation of the previously mentioned impurities that will go one by one to the PED through a diaphragm selection valve. The second channel will use the same hardware configuration as the first channel except that no molecular sieve column will be added. Then, after the elution of CO₂ through the pre- column, the heavier impurities as propylene, ethylene and others will be vented out of the system. Again, the CO₂ will be redirected to the PlasmaDete2 through the selection valve.

For some other RGA applications, it is also required to measure some light hydrocarbons and sulfurs. For these cases, the MultiDetek2 is so flexible that the configuration can be modified to achieve such measurement capability in the same compact chassis.

For example, the trace H₂S analysis can be added in the same channel as the one already used to trace CO₂ with the Q Bond column. No need to add extra detector as FPD or PFPD as generally used since the same PlasmaDetek2 can detect low concentration sulfurs. In the case that H₂S is added, then coated gas lines must be used to reduce surface adsorption. The detector doesn't have to be modified since it is made of Quartz, which is perfectly inert to trace sulfur.

For the light hydrocarbon analysis using the same MultiDetek2, a diaphragm valve network channel combined with Alumina type column and a second PlasmaDetek2 configured for hydrocarbons can be added. It is also possible to add an FID detector in the same unit if required.

THE MULTIDETEK2 CAN BE USED IN MANY DIFFERENT APPLICATION FIELDS RELATED TO THE REFINERY GAS ANALYSES.

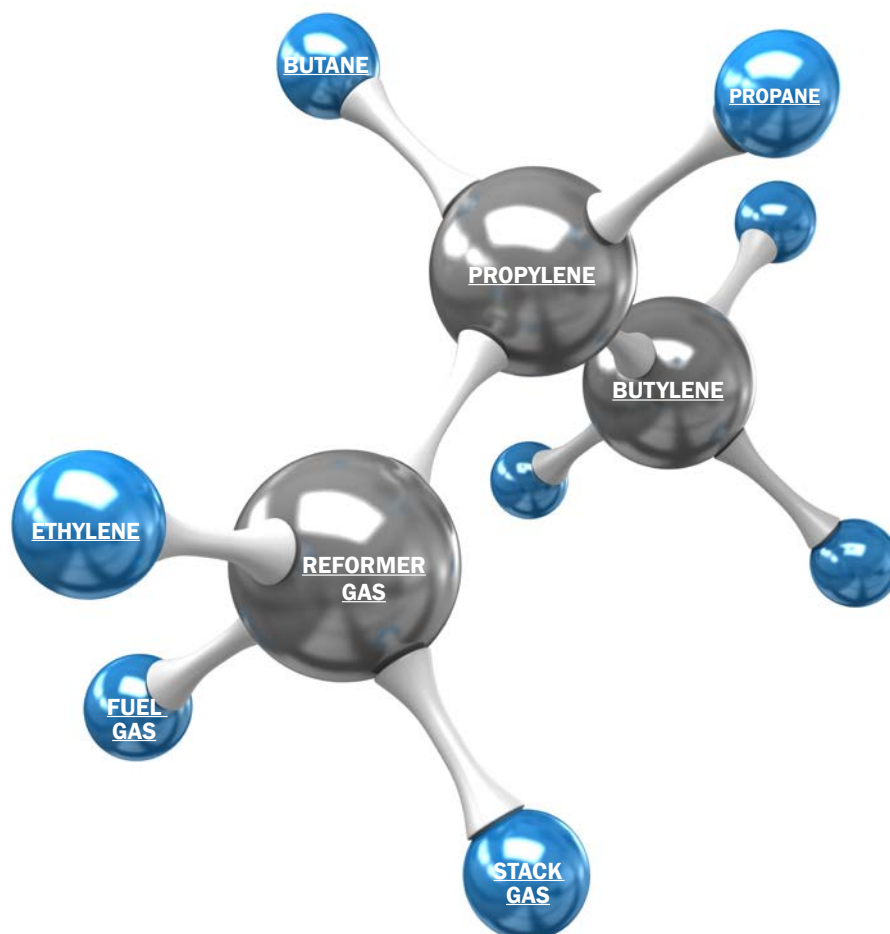

RESULTS:

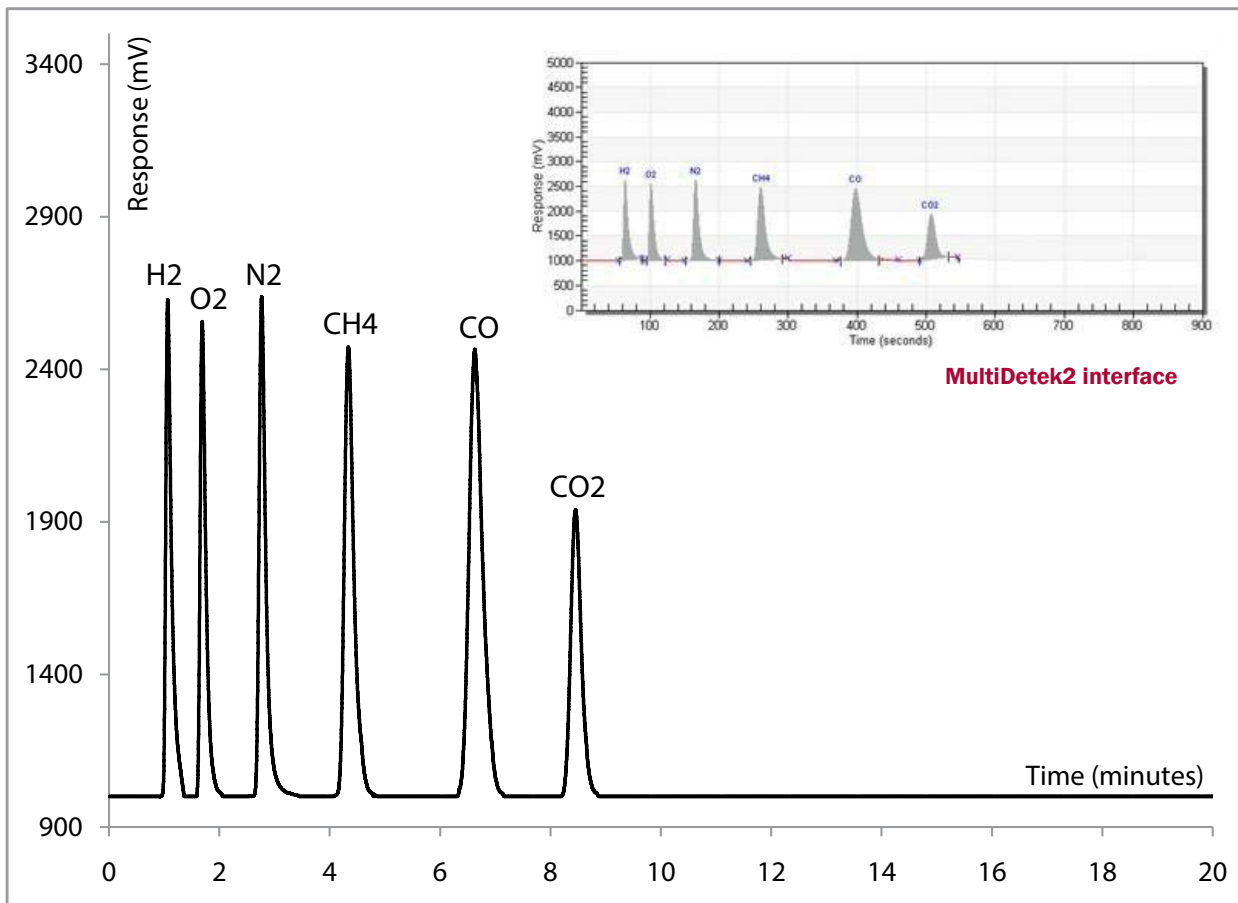

Figure 1: Chromatogram of trace impurities in balance Propylene

Historic Values

	H2	O2	N2	CH4	CO	CO2
0:31	8.103	9.177	10.531	9.687	9.675	5.186
7:05	8.090	9.163	10.532	9.680	9.578	5.193
3:39	8.140	9.185	10.545	9.674	9.544	5.198
0:14	8.113	9.184	10.537	9.657	9.578	5.171
4:03	8.044	8.981	10.532	9.657	9.475	5.188
0:37	8.155	9.197	10.564	9.695	9.578	5.198
7:11	8.155	9.209	10.586	9.694	9.695	5.113
3:46	8.253	9.129	10.596	9.668	9.578	5.138
0:19	8.232	9.163	10.655	9.638	9.535	5.198
5:53	8.233	9.226	10.612	9.602	9.544	5.226
3:28	8.017	9.163	10.564	9.628	9.475	5.193
0:02	8.265	9.271	10.545	9.602	9.475	5.233
5:35	8.218	9.267	10.579	9.644	9.578	5.198
3:10	8.155	9.129	10.564	9.657	9.696	5.236

More... On Chart... Ok Delete Cancel

Figure 2: Results showing stability from a mixture cylinder containing trace impurities in balance gas Propylene

COMPONENT	CONCENTRATION	PEAK HEIGHT	NOISE	LDL (3X NOISE)
H ₂	8.155 ppm	2701 mV	2.2 mV	0.020 ppm
O ₂	9.129 ppm	2655 mV	1.5 mV	0.015 ppm
N ₂	10.564 ppm	2740 mV	1.1 mV	0.012 ppm
CH ₄	9.657 ppm	2501 mV	2 mV	0.023 ppm
CO	9.696 ppm	2482 mV	2.5 mV	0.029 ppm
CO ₂	5.236 ppm	2010 mV	2.1 mV	0.016 ppm

Note: other LDL could be obtained with different injection volume and chromatographic conditions

Figure 3: LDL based on 3 times noise ratio

CONCLUSION:

With this simple method, the MultiDetek2 compact and robust GC brings an innovative solution for this type of application. The platform also offers the standard industrial communication protocols, the remote connectivity and a built-in or external PC with software interface. The refinery gas analysis market can now have a compact, robust and flexible GC analyzer using a single detector type (PlasmaDetek2) and a single carrier type to cover the whole range of applications.

APPLICATION NOTE

LD17-01



Trace Hydrocarbons and Permanent gases in Propylene



The high purity Propylene is used for the production of Polypropylene in Petrochemical industry. The analysis of trace impurities is critical to ensure a good quality of the final product. The analysis of hydrocarbons and permanent gases are required at a level below 10ppm to ensure the good operation of the production process.

LDETEK SOLUTION:

Using the PlasmaDetek2(PED) plasma detector and the MultiDetek2 compact gas chromatograph, the analysis of the most critical trace impurities in Propylene can be achieved in one unit with a single detection technology (PED).

The main advantage of our solution is to use the same PlasmaDetek2 (PED) detector to measure trace impurities hydrocarbons and permanent gases in the same system. Usually, the alternative solutions have to combine more than one detector to be able to cover this application. Typically, FID and PDHID have to be combined, resulting of multi gas feeding for the different detectors. Our solution requires only one PED detector with only carrier gas to feed the system.

Our configuration has 4 channels having each an independent oven/column. The four channels all merge in the same PlasmaDetek2 detector. The detector is optimized with a combination of selective optic circuits especially for each impurity. This allows a good sensitivity and selectivity over the propylene background gas.

- ▶ **Channel#1:** Trace O₂, N₂, CH₄, CO
- ▶ **Channel#2:** Trace CO₂, C₂H₂, C₂H₄, C₂H₆, C₃H₈
- ▶ **Channel#3:** Trace i-C₄H₁₀, n-C₄H₁₀
- ▶ **Channel#4:** Trace t-2-C₄H₈, i-C₄H₈, i-C₅H₁₂, C-2-C₄H₈, n-C₅H₁₂, 1.3-C₄H₆

RESULTS

The chromatogram below shows an example of a typical calibration containing trace impurities in a balance gas of pure propylene. The concentrations of each impurities along with the response and detection limit are listed in the LDL chart below.



COMPONENT	CONCENTRATION	PEAK HEIGHT	NOISE	LDL (3X NOISE)
CO ₂	8.024 ppm	2820 mV	2.2 mV	18.8 ppb
C ₂ H ₂	9.408 ppm	2556 mV	2.2 mV	24.2 ppb
C ₂ H ₄	10.574 ppm	2899 mV	2.2 mV	24.0 ppb
C ₂ H ₆	12.845 ppm	3009 mV	2.2 mV	28.2 ppb
C ₃ H ₈	4.386 ppm	3086 mV	2.9 mV	12.3 ppb
O ₂	10.305 ppm	1770 mV	0.9 mV	15.7 ppb
N ₂	9.507 ppm	2758 mV	1.1 mV	11.4 ppb
CH ₄	9.892 ppm	3176 mV	2.2 mV	20.5 ppb
CO	9.122 ppm	3096 mV	2.8 mV	24.7 ppb
T-2-C ₄ H ₈	2.165 ppm	578 mV	2.2 mV	24.7 ppb
I-C ₄ H ₈	2.311 ppm	764 mV	2.2 mV	19.9 ppb
I-C ₅ H ₁₂	8.887 ppm	2865 mV	2.2 mV	20.5 ppb
C-2-C ₄ H ₈	9.102 ppm	3643 mV	2.2 mV	16.5 ppb
N-C ₅ H ₁₂	7.994 ppm	2424 mV	2.2 mV	21.8 ppb
I-C ₄ H ₁₀	9.111 ppm	3110 mV	2.2 mV	19.3 ppb
N-C ₄ H ₁₀	9.291 ppm	3121 mV	2.2 mV	19.6 ppb
1,3C ₄ H ₆	4.100 ppm	1256 mV	2.2 mV	21.5 ppb

Note: other LDL could be obtained with different injection volume and chromatographic conditions

CONCLUSION:

Our solution combining a PlasmaDetek2 (PED) with a compact GC MultiDetek2 is simple and robust for this type of application required by the market. Our solution also includes the standard industrial communication protocols to control the unit.



3.0 APPLICATION NOTE

3.4 AGRICULTURE



3.0 APPLICATION NOTES

APPLICATION NOTE

LD15-01



Measurement of hydrocarbons, including the organic hormone (Ethylene) in CO₂ production with MultiDetek-2 and PlasmaDetek-E.



MultiDetek-2

A Greenhouse CO₂ environment is commonly used for the production of organics like fruits, plants and flowers. In this case, the production and control of the CO₂ gas purity are critical to ensure the proper growth of the organics.

LDETEK SOLUTION:

The recovery of the flue gas waste is one major source of low cost CO₂ production and it is also part of an environmental well-known solution. The sample gas is extracted from the flue gas or the pure CO₂ source by the gas provider via a sampling unit. After cooling it back to an acceptable temperature, the sample is filtered and dried by sampling filters and a dew point dryer. After this step, a sample pump is simply carrying the sample with a limited flow at a fixed pressure to the MultiDetek-2 and other flue gas sensors. The analyzers are located on the outside of the catalyst building. The sample gas is pumped from the MultiDetek-2 integrated pump that is used to fill the sampling loops for analysing.

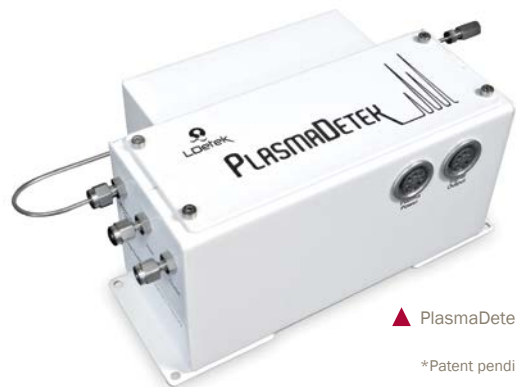

PlasmaDetek-E

*Patent pending

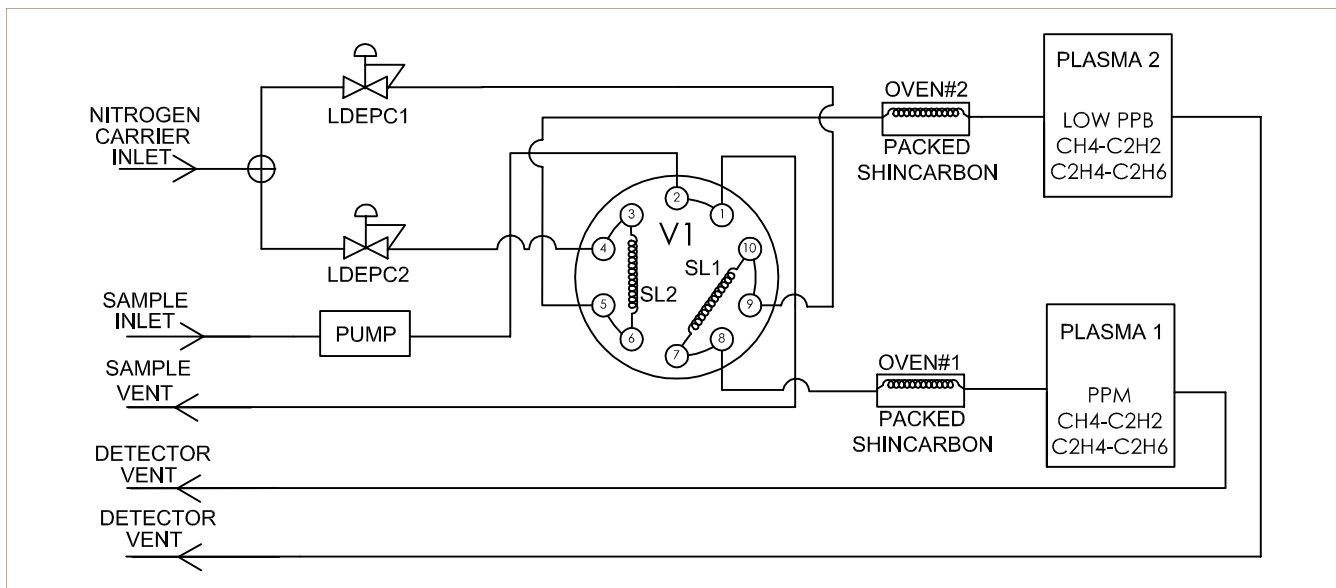

MultiDetek-2 configuration diagram 1: Valve position OFF: Filling both sampling loops

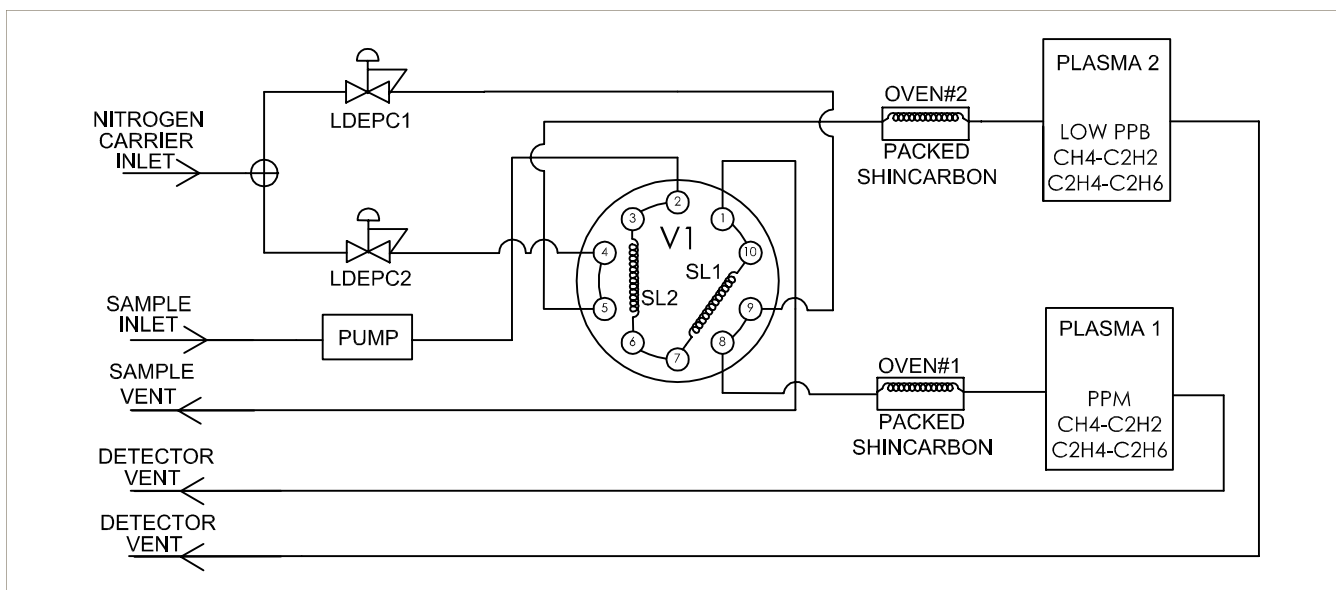

MultiDetek-2 configuration diagram 2: Valve position ON: Injecting both sampling loops in dual channels and running parallel analysis

A ten-port double injection valve is configured to inject both sampling loops at the same time through the dual channels. Each channel is configured with a Shincarbon packed column mounted in an isothermal or mini-programmable oven. The loop sizes and Plasma configurations allow a detection range going from 5ppb up to 3000ppm (other ranges are easily configurable depending on the requested application). The analysis time is speed up by using parallel chromatography technique and the possibility of using the LDetek mini-programmable ovens. This way, the high ppm and low ppb can be analyzed simultaneously to allow the full control of the process. The MultiDetek-2 will automatically select the appropriate channel depending on the sample impurity concentrations detected during the analysis.

The enhanced selectivity of the LDetek PlasmaDetek-E (patent pending) gives the possibility of using a single injection configuration. This easy to use technique improves the system performances, accelerates the analysis time and reduces the maintenance interventions.

Conventional solutions will tend to use an FID for such analysis. However, such technology requires complex and costly installation with air and fuel gas supplies. Moreover, the safety surrounding the use of an FID becomes complex. Other alternative solution to an FID is the use of a conventional HID or a PED that are non selective to hydrocarbons in CO₂ matrix. This solution will lead to the use of complex chromatography configuration with heartcut valves to remove the interference of CO₂ background gas over the hydrocarbons.

RESULTS:

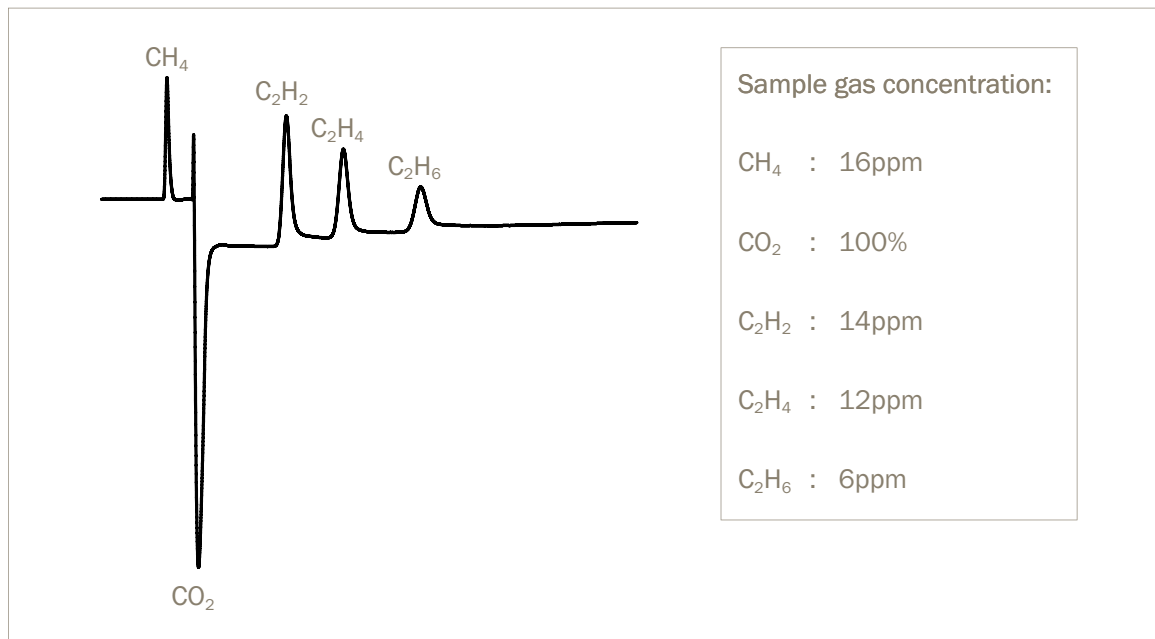

Chromatogram 1: Ppm hydrocarbon in pure CO₂ measured in MultiDetek-2 Channel #1

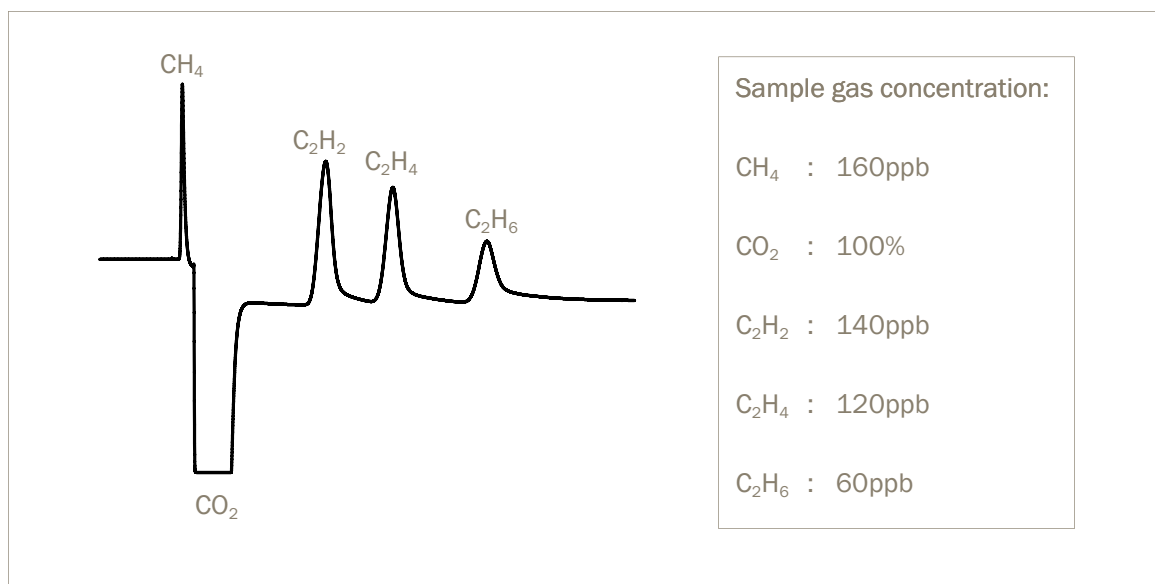

Chromatogram 2: Low ppb hydrocarbon in pure CO₂ measured in MultiDetek-2 Channel #2

CONCLUSION:

With its user-friendly interface and the simple configuration of this compact MultiDetek-2 GC, it is easy to use the instrument as a process control instrument that is a perfect fit for this Greenhouse application. Combined with the PlasmaDetek-E (patent pending) which is using a single Nitrogen source as carrier gas, this unique solution provides all the advantages to have a performing and reliable system for continuous monitoring of the CO₂ purity for Greenhouse.



3.0 APPLICATION NOTE

3.5 ELECTRONIC GASES & SEMICONDUCTOR

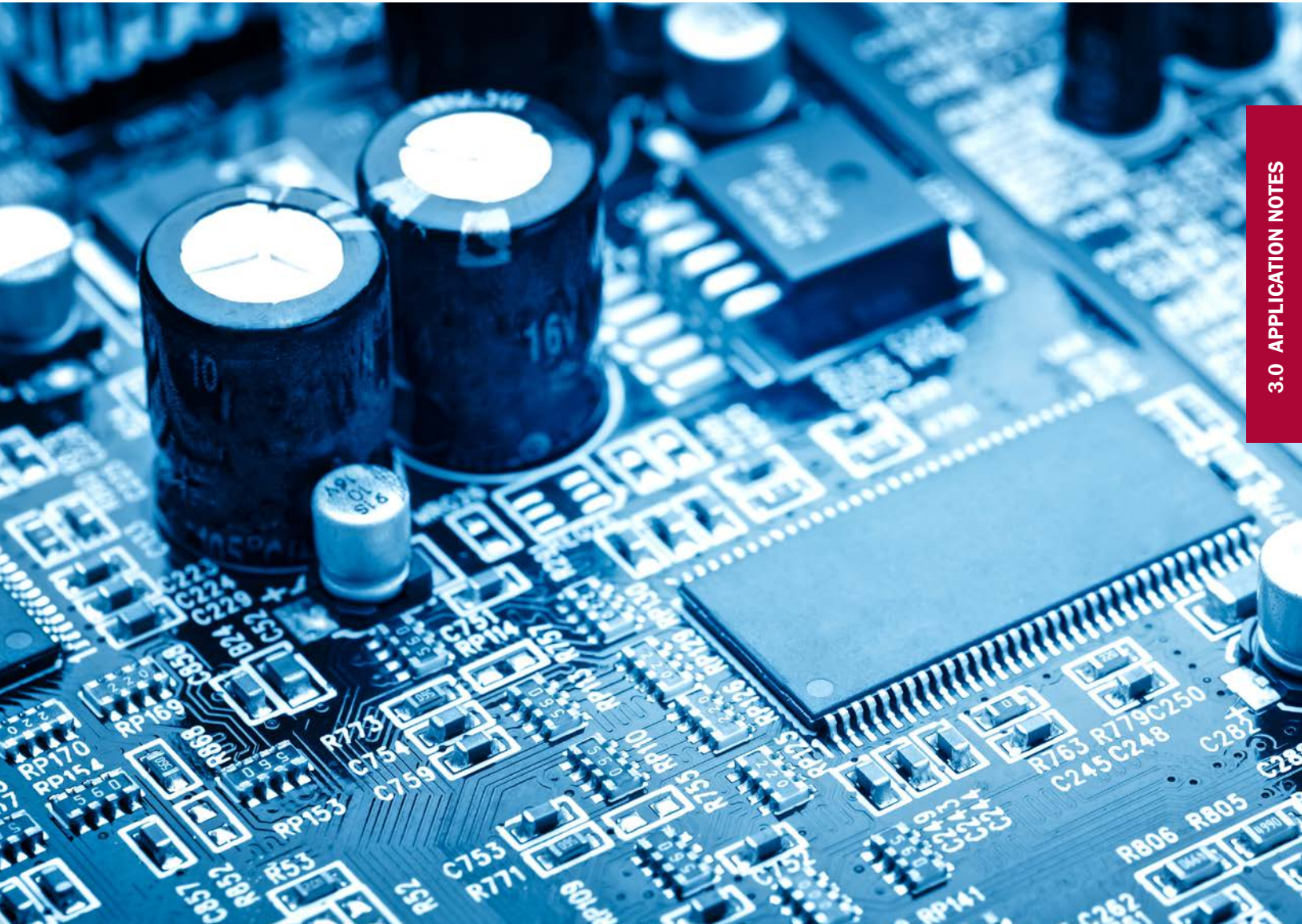

3.0 APPLICATION NOTES

APPLICATION NOTE

LD15-02



Measurement of part per billion Ar and N2 in oxygen for semiconductor industry



MultiDetek2 ▲

The oxidation of silicon is a common and frequent step in the manufacture of integrated circuits (IC). The semiconductor industry requires the production of Ultra High Purity oxygen for the wafer production.

LDETEK SOLUTION:

The oxygen pipeline purity that goes to the semiconductor industry must be properly measured to ensure that there is no contaminant in it. It is critical and challenging to measure the ppb content of argon and nitrogen impurities in oxygen. The conventional technique used for such application is with a heated Oxy-Trap system combined with HID or conventional PED. Such technique requires a complex chromatography system with periodic Oxy-Trap regeneration with hydrogen. The operations of such system require a lot of maintenance and specialist interventions on a routine basis. The limitation of the lifetime of the trap reduces the continuous operation. Depending on the system condition, the Oxy-Trap has to be regenerated more or less once a week.

Our solution consists of eliminating all the consumables and ensuring continuous operation without maintenance and specialist intervention. Moreover, LDetek can also offer an all in one solution using the MultiDeteks-2 combined with the PlasmaDetek-E for monitoring the CO, CO2 and some hydrocarbons which are critical impurities to measure for semiconductor gases.

Measuring Ar in oxygen :

A first channel using a straight 10 port double injection diaphragm valve V1 combined with the LDetek unique ArgoTek packed column to separate part per billion argon from pure oxygen at an isothermal temperature of 45° Celsius with a carrier flow rate of 20-30sccm. The helium is used as carrier gas source. There is no need of cryogenic or Oxy-Trap system as commonly used. As simple as a basic injection through our ArgoTek packed column to conduct the accurate analysis of argon in oxygen.

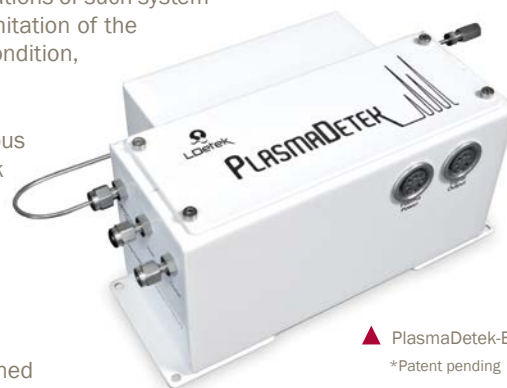

▲ PlasmaDetek-E
*Patent pending

Measuring N2 in oxygen :

A second channel still using the same straight diaphragm injection valve V1 is used to perform the analysis of N2 in oxygen with two packed molecular sieve columns combined with a Heartcut diaphragm valve V2. One more time, this configuration allows the measurement of N2 in oxygen without the use of a complex Oxy-Trap system. Both channels are selected accordingly at the right time with the selection diaphragm valve V3.

PlasmaDetek-E configuration for measuring Ar & N2 in oxygen :

The PlasmaDetek-E used for this system has a selective configuration to block the interference coming from the oxygen matrix. A specific optic circuit having its wavelength for measuring selectively the argon is mounted in the PlasmaDetek-E. Another specific optic circuit also having its wavelength for selectively measuring the N2 is in place. The appropriate optic circuit is automatically selected at the proper elution time to allow peak integration. The selectivity of the PlasmaDetek-2 for the Ar-N2 in oxygen gives the ability to have an easy to use system allowing quick analysis time even at ultra low concentration.

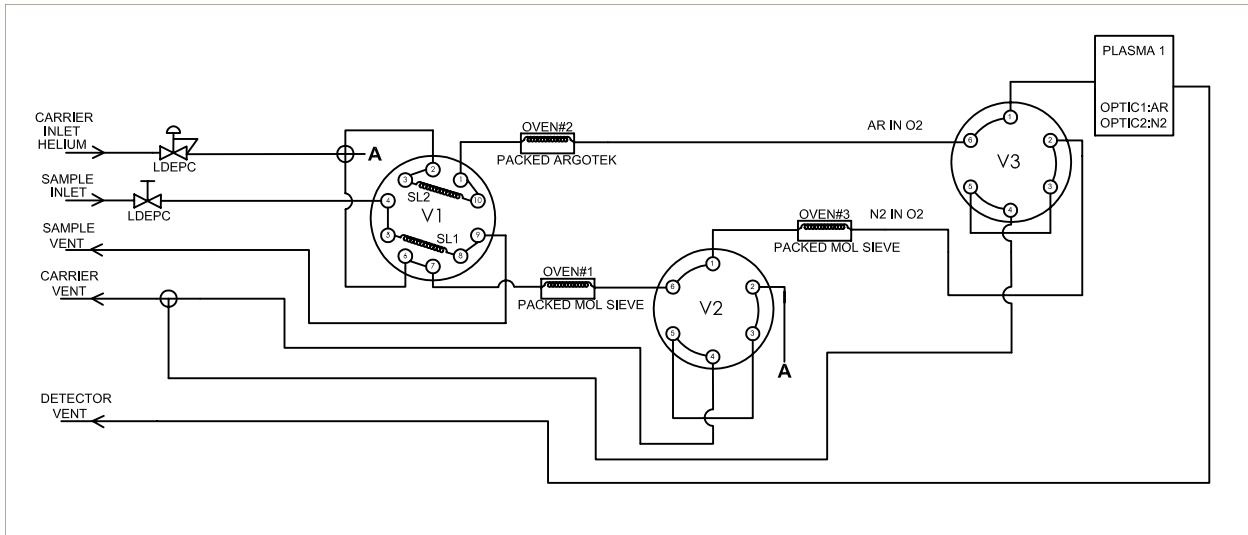

MultiDetek-2 configuration diagram 1: V1 position OFF: Filling loop #1 and injecting loop #2
V2 position OFF: Catch N2 peak from the first Packed Mol Sieve in Oven #1 to the second Packed Mol Sieve in Oven #2
V3 position OFF: Select channel #2 for Ar in O2 to the PED

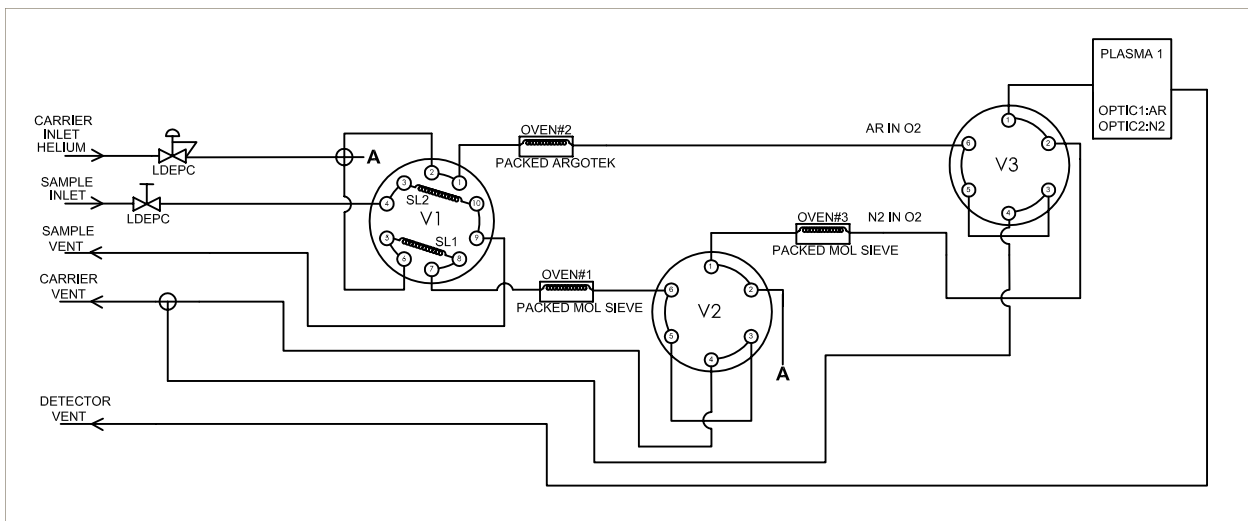

MultiDetek-2 configuration diagram 2: V1 position ON: Injecting loop #1 and filling loop #2
V2 position ON: Venting oxygen out of the system
V3 position ON: Select channel #1 for N2 in O2 to the PED

RESULTS: Linearity on a 0-10ppm range

Argon impurity

DILUTED GAS (PPM)	CALCULATED VALUE (PPM)
0.081	0.079
0.35	0.31
1.3	1.29
3.13	3.15
4.73	4.8
9.6	9.543

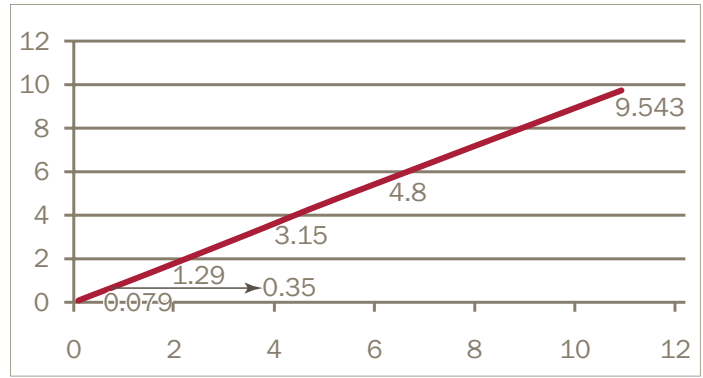

Nitrogen impurity

DILUTED GAS (PPM)	CALCULATED VALUE (PPM)
0.097	0.094
0.53	0.518
1.4	1.336
3.36	3.21
5.07	4.938
10.3	10.395

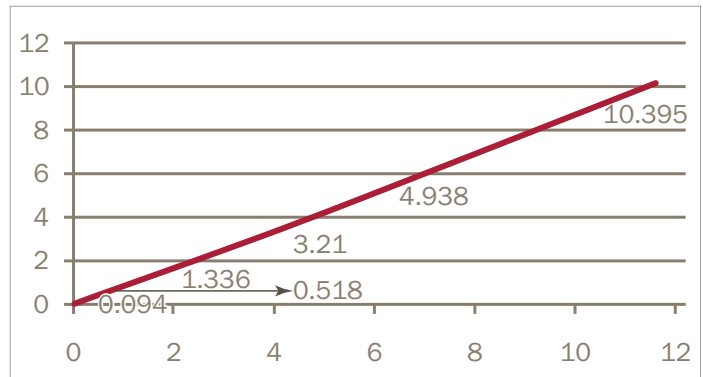

LOW PPB CHROMATOGRAM EXAMPLES:

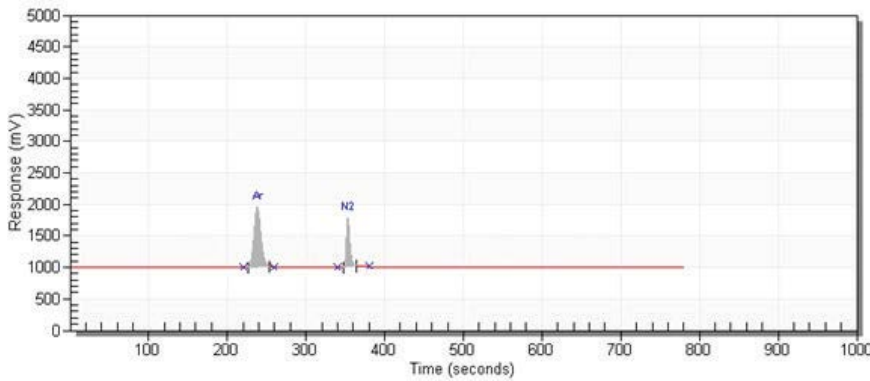

Chromatogram 1:
61ppb Ar & 77ppb N2 in pure oxygen

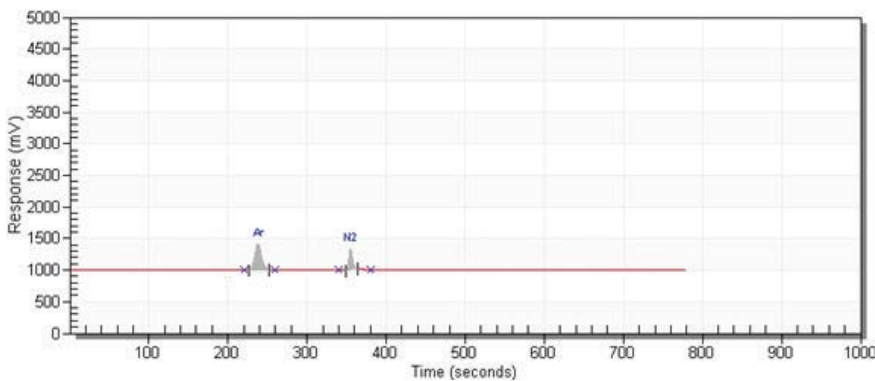

Chromatogram 2:
30ppb Ar & 38ppb N2 in pure oxygen

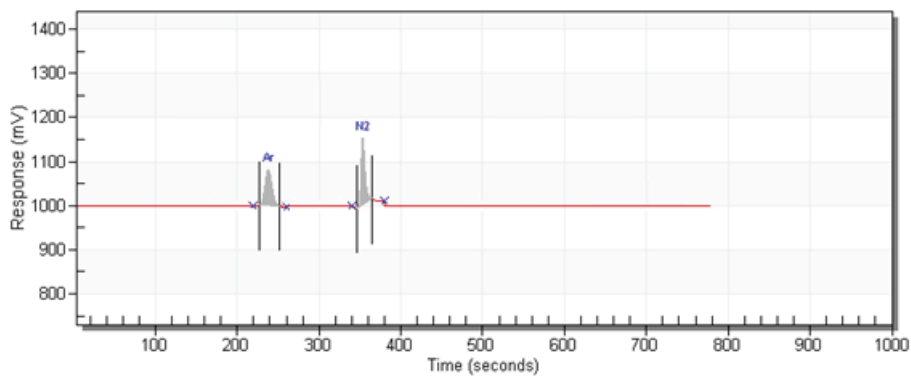

Chromatogram 3:
3ppb Ar & 3.8ppb N2 in pure oxygen

LDL calculation

COMPONENT	CONCENTRATION	PEAK HEIGHT	NOISE	LDL (3X NOISE)
Ar	3ppb	95 mV	1.5 mV	0.1 ppb
N ₂	3.8ppb	156 mV	2.7 mV	0.2 ppb

Note: other LDL could be obtained with different injection volume and chromatographic conditions

CONCLUSION:

With its user friendly interface and the simple configuration of this compact MultiDetek-2 GC, it is easy to use the instrument as a process control analyser that is a perfect fit for this semiconductor application. The enhanced sensitivity and selectivity of the PlasmaDetek-E allows extreme low limit of detection. Combined with the LDetek exclusive ArgoTek column, it makes this system perfectly suitable for semiconductor industry.

APPLICATION NOTE

LD15-04



Measurement of silane purity in electronic gases industry using PlasmaDetek-E and MultiDetek2



Silane (SiH_4), more properly known as monosilane and alternately called silicon tetrahydride or silicane, is a highly flammable and hazardous chemical compound containing silicon (87.45%) and hydrogen (12.55%). With silicon comprising 87.45% of its content by weight, pure silane is a primary source of high-purity silicon for use in industry. It is a critical gas in the manufacture of semiconductor devices, display panels and other electronic devices. The analysis of ultra low part per billion of permanent gases in silane is required for measuring the silane purity. The use of the LDetek compact & industrial MultiDetek2 GC combined with the PlasmaDetek-E is the perfect fit for this domain of application.

LDETEK SOLUTION:

Handling highly flammable gases like silane requires a high level of safety and this is what LDetek offers with its built-in sample purging and monitoring system inside the MultiDetek2 compact GC. This system consists of 4 steps of safety:

Step 1: The sample gas flow path external to the purge box is fully welded offering no possibility of leakage.

Step 2: A selection valve (V1) is mounted before the diaphragm valves used for filling the sampling loops in the system. That selection valve (V1) is configured to allow silane to go to the sampling loops only for a predetermined period of time, just before the start of each

analysis. The short period of time is configured in the factory and depends on the system configuration. The rest of the time, the selection valve (V1) is switched to a purge gas, which is normally the same gas type as the carrier gas of the system for purging the sampling loops. In the eventuality of leakage on the sampling loops or on the injection diaphragm valves, the reduced period of time introducing silane in the injection valves combined with the low pressure operation and small volume will avoid any potential hazardous situation.

Step 3: A sealed purge box containing the sample flow electronic pressure controller (LDEPC2) and the diaphragm selection valve (V1) is mounted in the MultiDetek2 chassis. That box is normally purged with the same gas type as the carrier gas used for the system. That environment requires low purge flow rate of about 10-30 sccm through a fixed orifice depending on the system configuration. The box is fully ambient air free and the system is ready to use after a short period of about 20-30 minutes depending on the system configuration. This waiting period is only required for initial start-up since once the MultiDetek2 has carrier flow going in it, the box is continuously on purge. Having a box fully purged with UHP carrier gas eliminates the ignition risk in potential presence of silane. A 1psig relief valve (RV) is mounted on the box to build up a minimum sealing pressure and to maintain a constant purge with the carrier gas.

Step 4: The sealed purge box is continuously monitored using a micro PED (PLASMA2) to selectively measure trace N2 to ensure there is no air contamination in the sealed box to avoid the ignition in the potential presence of silane. If trace of air is measured in the purge box by the micro PED (PLASMA2), then an alarm is activated to shut off the flow of silane gas inside the MultiDetek2. The shut-off valve must be mounted external to the MultiDetek2 chassis. The feedback signal controlling the shut off valve comes from the MultiDetek2. It is required to maintain the sample gas pressure coming to the shut-off valve below 10psig to minimize the risk of ignition.

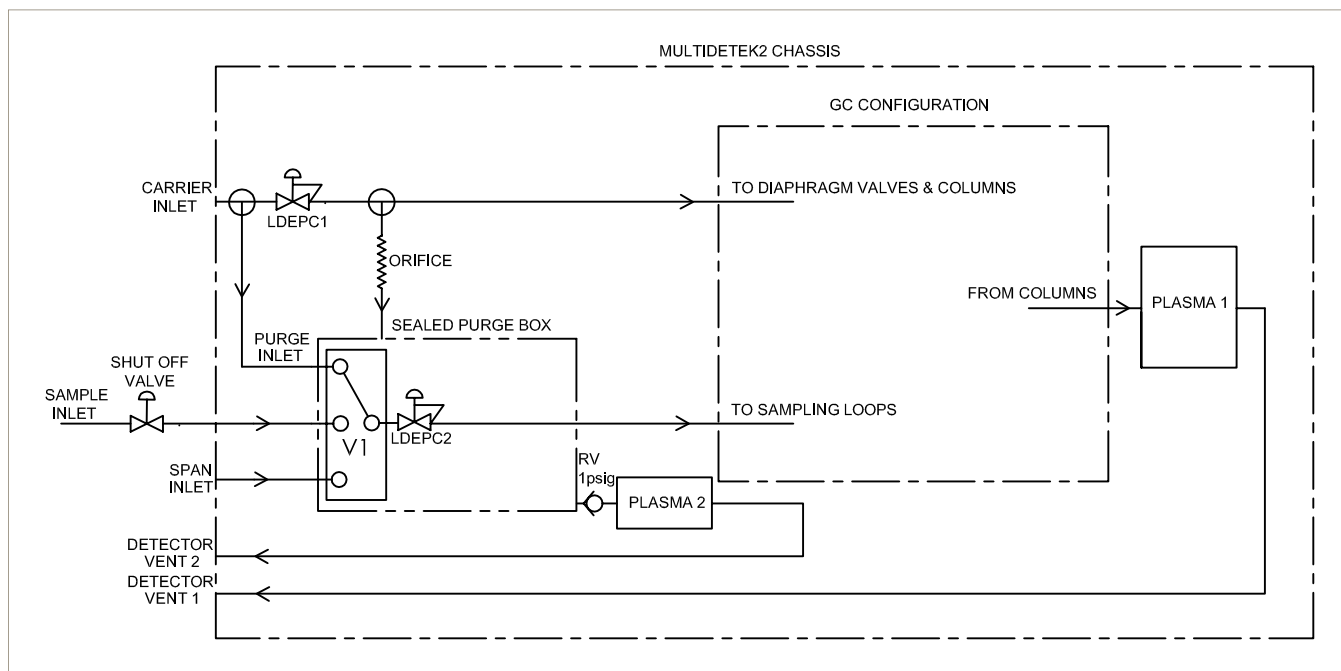

The flow type selected by the selection valve (V1) is controlled with the electronic flow controller (LDEPC2) to ensure a stable and constant flow rate whichever the selected gas type.

The GC configuration for this application is configured with Stainless Steel purge diaphragm valves and MXT column types. At the end of the GC configuration, a PlasmaDetek-E detector is configured to selectively measure the impurities requested. Multiple channels can be configured depending on the application. For this application note, the analysis of H₂-O₂-N₂-CH₄-CO is measured through channel #1 and the CO₂ through channel#2. Both channels are combined together and go in the PlasmaDetek2 detector. The highly sensitive PlasmaDetek-E allows good detection limit, what is required for silane purity.

RESULTS:

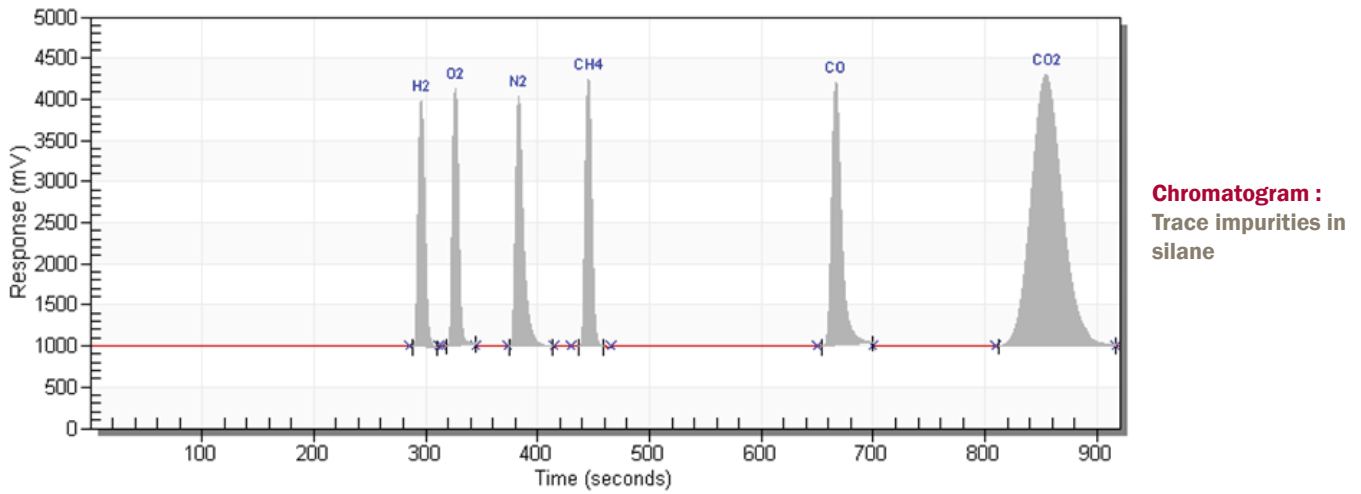

Chart : LDL calculation:

COMPONENT	CONCENTRATION	PEAK HEIGHT	NOISE	LDL (3X NOISE)
H ₂	808 ppb	2995 mV	3 mV	2.5 ppb
O ₂	810 ppb	3220 mV	3 mV	2 ppb
N ₂	810 ppb	3095 mV	2 mV	1.5 ppb
CH ₄	810 ppb	3335 mV	3 mV	2 ppb
CO	820 ppb	3297 mV	4 mV	3 ppb
CO ₂	820 ppb	3380 mV	3 mV	2 ppb

Note: other LDL could be obtained with different injection volume and chromatographic conditions

CONCLUSION:

The PlasmaDetek-E and the MultiDetek2 combined with the highly safe continuous monitoring sampling system allow the measurement of silane purity with reduced risk. The N₂ monitoring of the purge box is essential to ensure there is no ignition risk inside the MultiDetek2.

The measurement of trace of impurities can be performed with a relatively short analysis time, and can offer very low limit of detection what is required for silane purity.

APPLICATION NOTE

LD18-01



Measurement of trace impurities in Germane (GeH₄) for electronic gas industry using PlasmaDetek2 and MultiDetek2

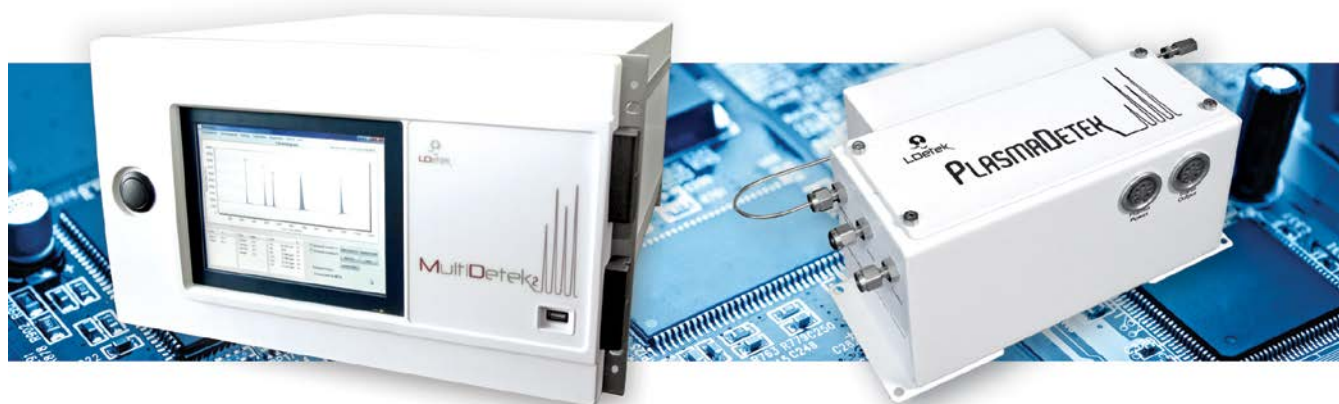

▲ MultiDetek2

▲ PlasmaDetek2
patent US 9,310,308 B2

LDETEK SOLUTION:

Handling highly flammable gas like germane (GeH₄) requires a high level of safety and it is what LDetek offers with its built-in sample purging and monitoring system inside the MultiDetek2 compact GC. This system consists of 4 steps of safety:

Step 1: The sample gas flow path external to the purged box is fully welded offering no possibility of leakage.

Step 2: A selection valve is mounted before the diaphragm valves used for filling the sampling loops in the system. That selection valve is configured to allow GeH₄ going to the sampling loops only for a pre determined period of time just before to start each analysis. The short period of time is configured in factory and is dependant to the system configuration. The rest of the time, the selection valve is switched on a purged gas which is normally the same gas type that the carrier gas of the system for purging the sampling loops. In the eventuality of leakage on the sampling loops or on the injection diaphragm valves, the reduced period of time introducing GeH₄ in the injection valves combined with the low pressure operation and small volume will avoid any potential hazardous situation.

Step 3: A sealed purge box containing the sample flow electronic pressure controller and the diaphragm selection valve is mounted in the MultiDetek2 chassis. That box is normally purged with the same gas type that the carrier gas used for the system. That environment requires low purge flow rate of about 10-30sccm through a fix orifice depending of the system configuration. The box is fully ambient air free and the system is ready to use after a short period of about 20-30minutes depending of the system configuration. This waiting period is only requires for initial start up since once the MultiDetek2 has carrier flow going in it, the box is continuously on purge. Having a box fully purged with UHP carrier gas eliminates the ignition risk in potential presence of GeH4. A 1psig relief valve (RV) is mounted on the box to build up a minimum sealing pressure and to maintain a constant purge with the carrier gas.

Step 4: The sealed purge box is continuously monitored using a micro PED (PLASMA2) to selectively measure trace N2 to ensure there is no air contamination in the sealed box to avoid the ignition in potential presence of GeH4. If trace of air is measured in the purged box by the micro PED, then an alarm is activated to shut off the flow of GeH4 gas inside the MultiDetek2. The shut off valve must be mounted external to the MultiDetek2 chassis. The feedback signal controlling the shut off valve comes from the MultiDetek2. It is requires to maintain the sample gas pressure coming to the shut off valve below 10psig to minimize the risk of ignition.

The flow type selected by the selection valve is controlled with the electronic flow controller to ensure a stable and constant flow rate whichever the gas type selected.

The GC configuration for this application is configured with Stainless Steel purged diaphragm valves and MXT column types. At the end of the GC configuration, the PlasmaDetek-2 detector is configured to selectively measure the impurities requested. Multiple channels can be configured depending of the application. For this application note, the MultiDetek2 GC is configured as follow:

Trace impurities C2H2-C2H4-C2H6 → is measured through channel #1

Trace impurities Ar → is measured through channel #2

Trace impurities CO-CO2 → is measured through channel #3

Trace impurities H2-O2-N2-CH4 → is measured through channel #4

RESULTS:

Chromatograms : Trace impurities in GeH4

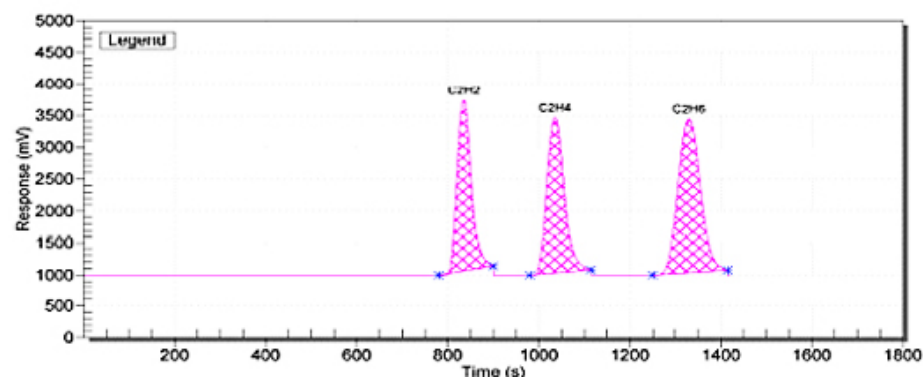

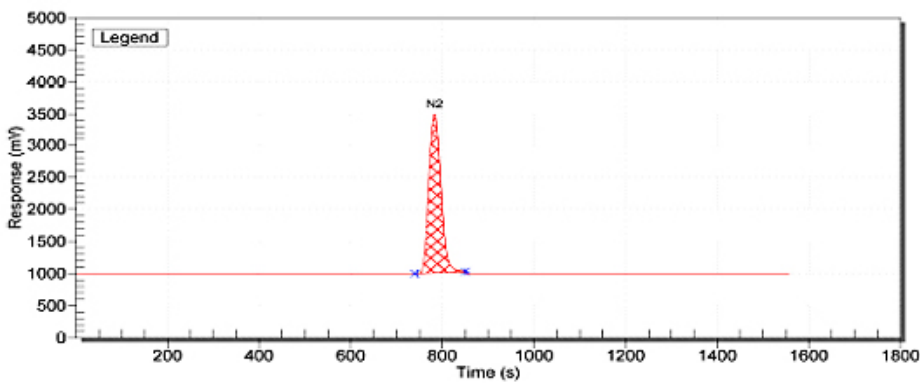
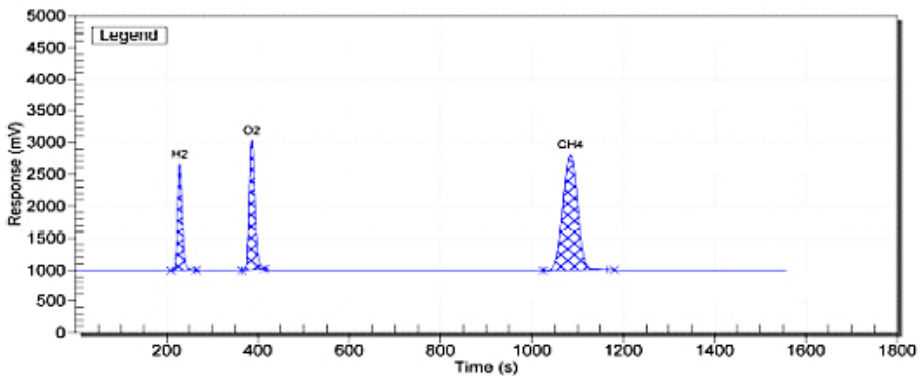
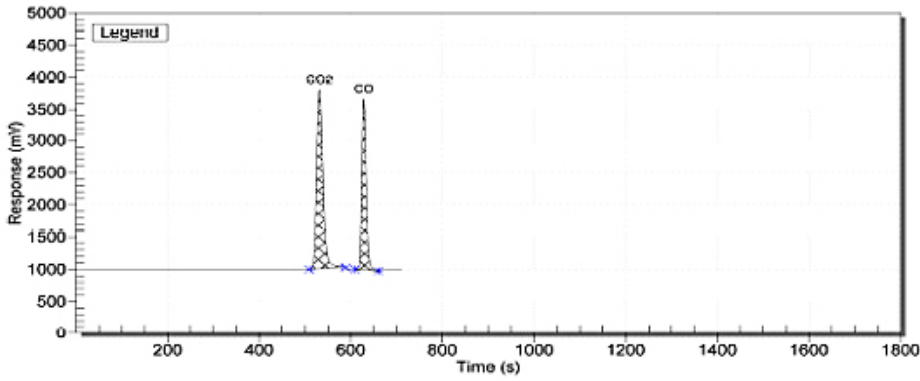
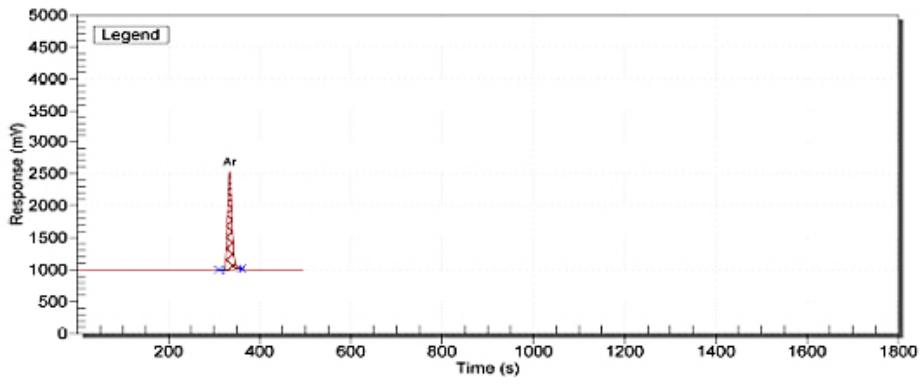

CHART: RESULTS, RESPONSE AND LDL CALCULATION

COMPONENTS	CONCENTRATION	PEAK HEIGHT	NOISE	LDL (3X NOISE)
C2H2	5.2 ppm	2720 mV	2.8 mV	0.016 ppm
C2H4	4.9 ppm	2495 mV	2.8 mV	0.016 ppm
C2H6	4.9 ppm	2433 mV	2.8 mV	0.017 ppm
Ar	3.1 ppm	1544 mV	1.1 mV	0.006 ppm
CO2	4.7 ppm	2802 mV	2.1 mV	0.010 ppm
CO	4.6 ppm	2705 mV	2.1 mV	0.010 ppm
H2	3.9 ppm	1701 mV	2.6 mV	0.018 ppm
O2	4.1 ppm	2065 mV	2.6 mV	0.015 ppm
CH4	3.6 ppm	1789 mV	2.6 mV	0.016 ppm
N2	3.7 ppm	2505 mV	0.7 mV	0.003 ppm

Note: other LDL could be obtained with different injection volume and chromatographic condition

CONCLUSION:

The PlasmaDetek2 and the MultiDetek2 combined with the highly safe continuous monitoring sampling system allows the measurement of GeH4 purity with reduced risk. The N2 monitoring of the purged box is essential to ensure there is no ignition risk inside the MultiDetek2.

The trace impurities measurement can be realized with a relatively short analysis time and can offer very low limit of detection of the measured impurities what is required for GeH4 purity analysis.

APPLICATION NOTE

LD19-02



Measurement of trace impurities in high purity Nitrogen trifluoride (NF₃) for electronic gas industry using PlasmaDetek2 and MultiDetek2 GC



The analysis of high purity nitrogen trifluoride is commonly used for the electronic market in the plasma etching of silicon wafers for the production of liquid crystal displays.

LDETEK SOLUTION:

The GC configuration for this type of application is generally configured with coated stainless steel purged diaphragm valves and coated MXT columns to improve the performances of the system. At the end of the GC configuration, the PlasmaDetek-2 detector is configured to selectively measure the impurities requested. Multiple channels can be configured depending of the application. For this application note, the MultiDetek2 GC is configured with 4 channels merging in the PED detector.

- ▶ **Trace H₂-Ar+O₂-N₂-CO impurities** measured with channel #1
- ▶ **Trace SF₆ impurities** measured with channel #2
- ▶ **Trace CO₂-N₂O impurities** measured with channel #3
- ▶ **Trace CH₄-CF₄ impurities** measured with channel #4

RESULTS:

Chromatogram : Trace CO₂-H₂-N₂-CO-CH₄ impurities in NF₃

Peak	Unit	Calibration Value	Area Counts
CO ₂	ppm	5.00	89184
H ₂	ppm	5.00	11170
N ₂	ppm	5.00	22814
CO	ppm	5.00	96257
CH ₄	ppm	5.00	64378

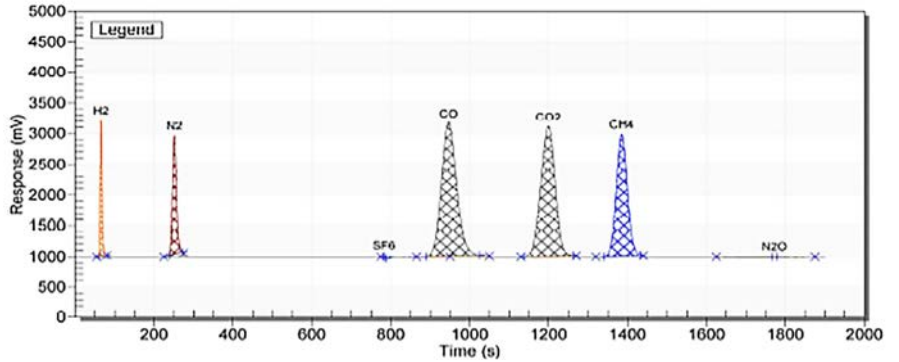

Chromatogram : Trace N₂O impurities in NF₃

Peak	Unit	Calibration Value	Area Counts
N ₂ O	ppm	4.90	114967

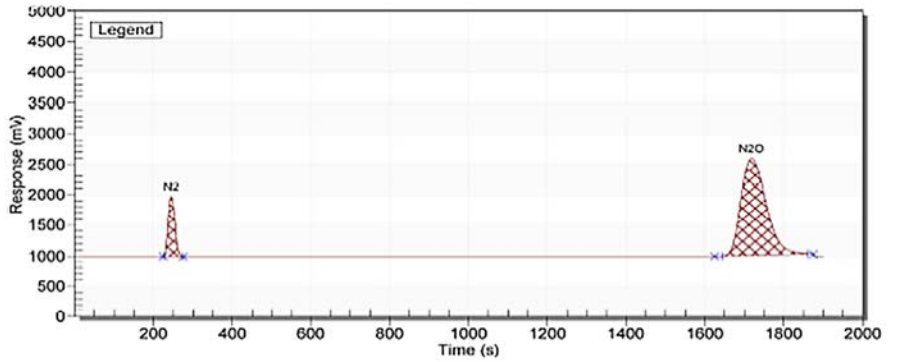

Chromatogram : Trace Ar+O₂ impurities in NF₃

Peak	Unit	Calibration Value	Area Counts
Ar+O ₂	ppm	5.00	19120

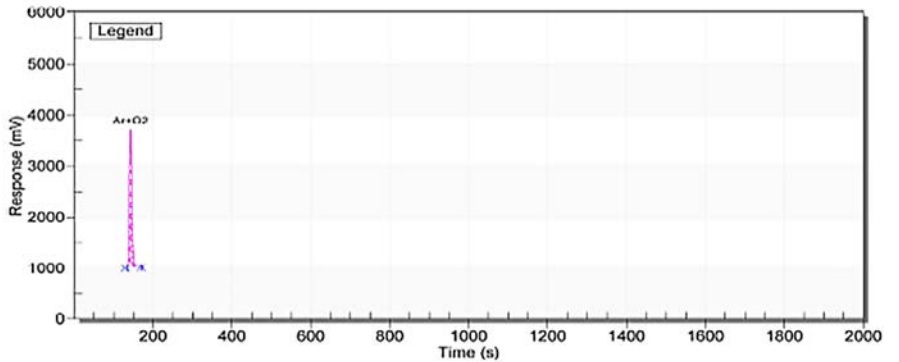

Chromatogram : Trace SF₆-CF₄ impurities in NF₃

Peak	Unit	Calibration Value	Area Counts
SF ₆	ppm	5.00	99694
CF ₄	ppm	5.00	100767

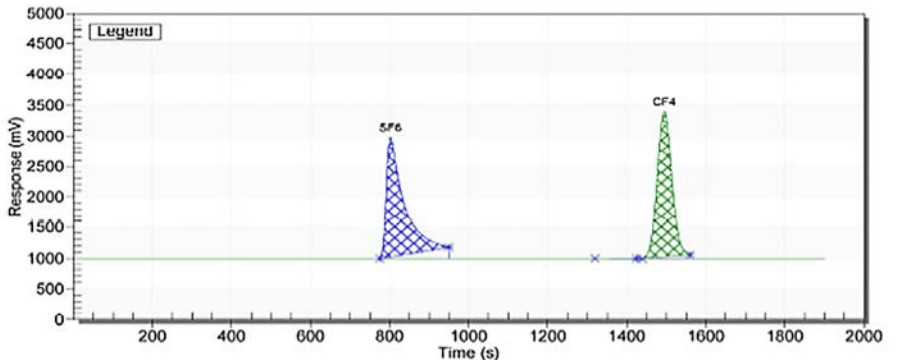

LIMIT OF DETECTION

COMPONENTS	CONCENTRATION	PEAK HEIGHT	NOISE	LDL (3X NOISE)
H2	0.27 ppm	150 mV	1.0 mV	5.4 ppb
Ar+O2	0.61 ppm	130 mV	1.0 mV	14.0 ppb
N2	0.46 ppm	200 mV	0.5 mV	3.4 ppb
CO2	0.18 ppm	93 mV	1.9 mV	11.0 ppb
CH4	0.18 ppm	80 mV	1.4 mV	9.4 ppb
CO	0.23 ppm	105 mV	2.3 mV	15.0 ppb
N2O	0.1 ppm	34 mV	2 mV	17.6 ppb
SF6	1.5 ppm	660 mV	1 mV	6.8 ppb
CF4	1.37 ppm	700 mV	3 mV	17.6 ppb

Note: other LDL could be obtained with different injection volume and chromatographic condition

Channel 1 : 0.27ppm H2

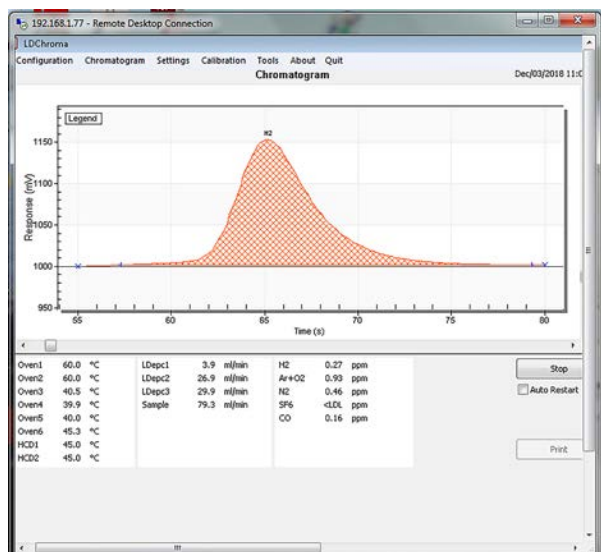

Channel 1 : 0.46ppm N2

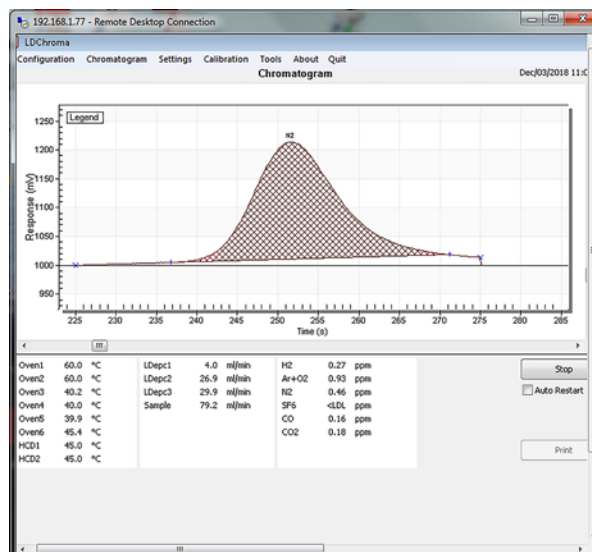

Channel 1 : 0.23ppm CO

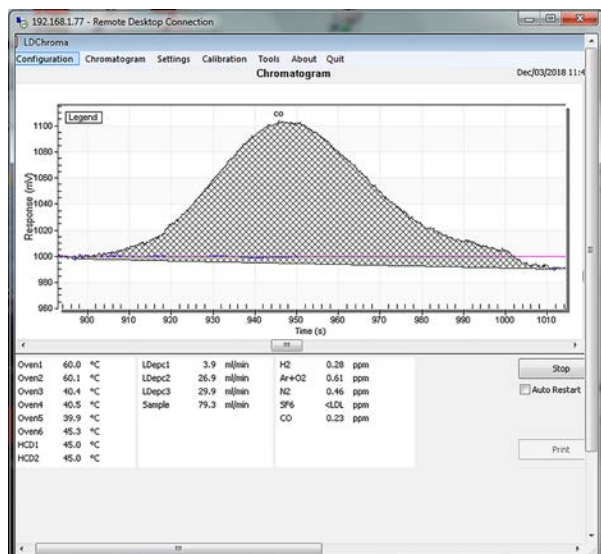

Channel 2 : 1.5ppm SF6

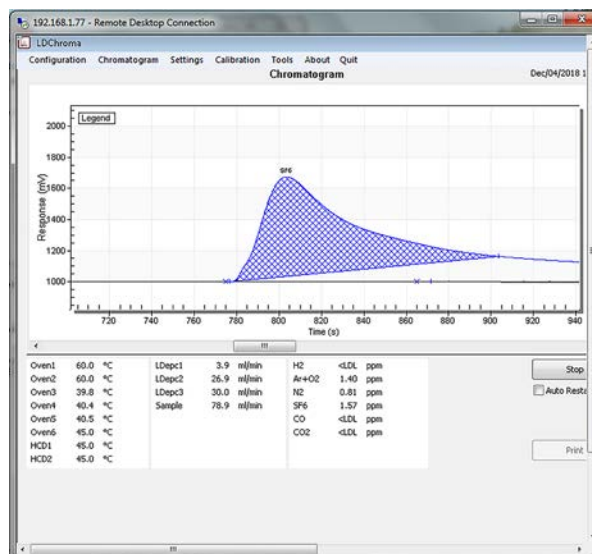

3.0 APPLICATION NOTES

Channel 3 : 0.18ppm CO2

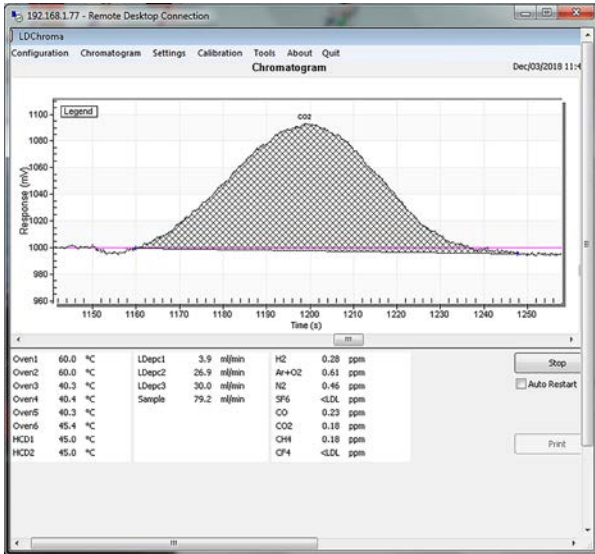

Channel 3 : 0.1ppm N2O

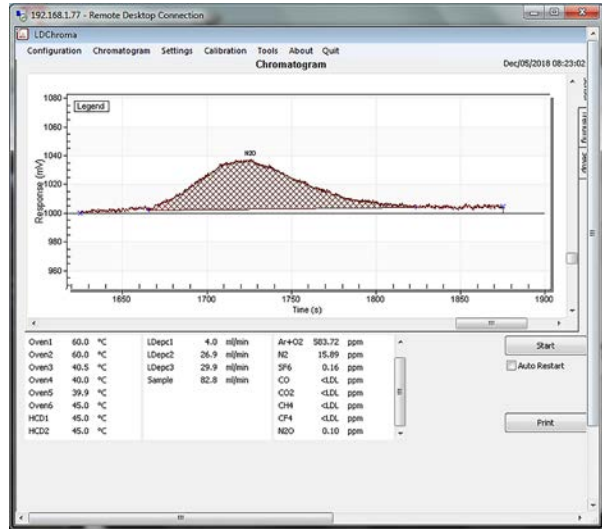

Channel 4 : 1.37ppm CF4

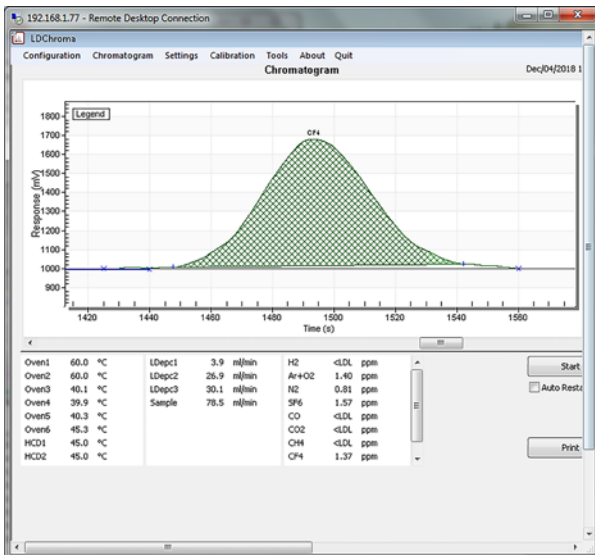

Channel 4 : 0.18ppm CH4

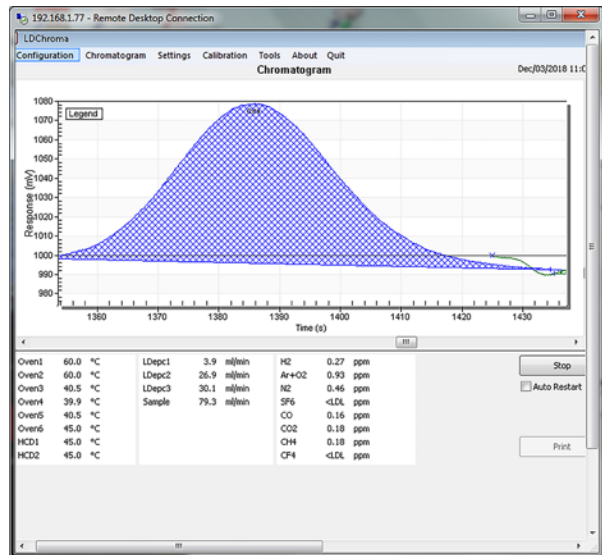

CONCLUSION:

The system is configured with the proper columns and valve configuration to get a quick analysis time and a robust configuration. The use of the PlasmaDetek2 offers a good selectivity for the detection allowing to get a relatively good short analysis time with good limit of detection.

APPLICATION NOTE

LD19-03



Measurement of trace impurities in high purity nitrous oxide (N₂O) for electronic gas industry using PlasmaDetek2 and MultiDetek2 GC



▲ MultiDetek2

▲ PlasmaDetek2
patent US 9,310,308 B2

Nitrous oxide (N₂O), often referred to as laughing gas, is used in the high-tech thin film industries of semiconductor and LCD display manufacturing. The primary application is the reaction with silane (SiH₄) or other silicon precursors to produce high-quality oxide films (SiO_x), which are used as electrical insulators in microelectronic transistors. N₂O is increasingly used to make thin-film oxides with other elements like titanium, aluminium, magnesium and zirconium. It is also used in the selective etching of semiconductor thin-films.

Nitrous oxide is a colourless, non-flammable gas at room temperature with a slightly sweet odour and taste and it is an oxidiser that can support combustion like oxygen. It is an electronic high-purity material produced from thermal decomposition of ammonium nitrate. Why is this gas used in electronics manufacturing? It is less reactive and therefore more selective, than oxygen. Often, this property is used to:

- ▶ **Control the amount of oxygen in a thin film**
- ▶ **Reduce the side oxidation reactions**
- ▶ **Selectively etch one thin film while allowing others to remain**

A addressable market than more than 10,000 metric tons N₂O continuously growing with the arrival of new higher-definition display technologies like ultra-high definition and OLED requiring higher amount of N₂O.

In addition to its use in electronics manufacturing, common applications of nitrous oxide are: anaesthetics, as food and beverage propellant (for whipped cream as example), as an industrial propellant and foaming agent and as a fuel oxidiser for rockets and race cars.

THE COMPLETE SOLUTION

This application note shows the configuration of a complete integrated system (LDrack rackmount cabinet).

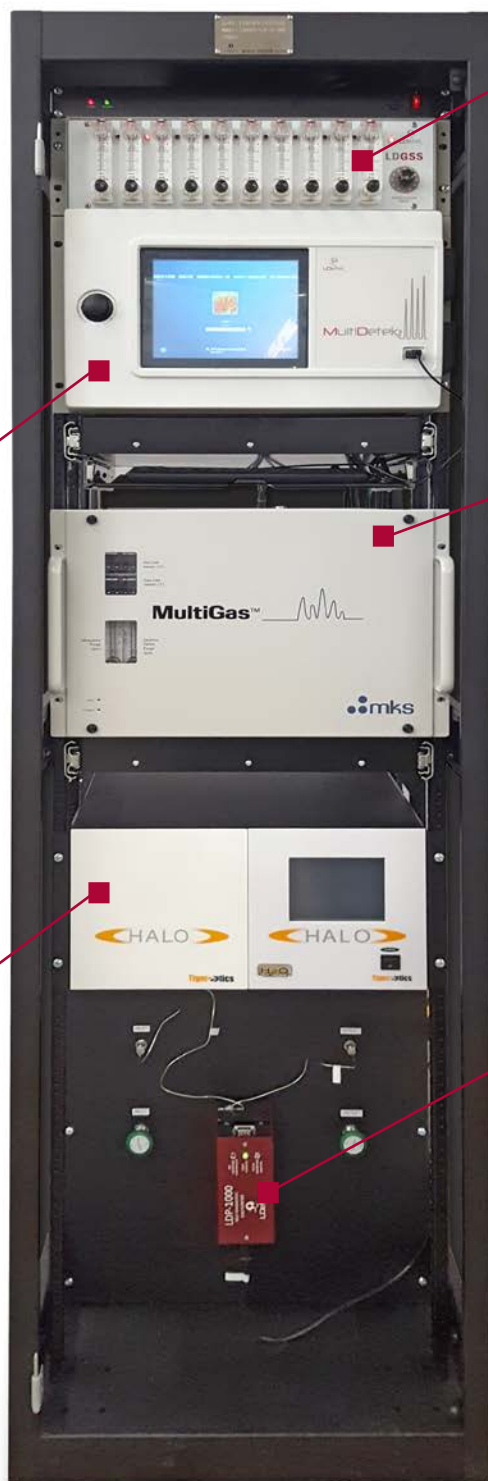

LDGSS

ultra high purity gas stream selector using stainless steel diaphragm valves for 10 streams.

MULTIDETEK2

compact/industrial GC for measuring trace ppb/ppm impurities H₂-O₂-N₂-CH₄-CO-CO₂ with addition of Ar-Ne and addition of C₂H₂-C₂H₄-C₂H₆ all in one instrument using one type of sensor (PlasmaDetek2) with helium as carrier gas.

MKS MULTIGAS

FTIR instrument for measuring ppb/ppm ammonia and NO_x.

TIGER OPTICS

Halo instrument for measuring ppb/ppm trace H₂O.

HEATED GAS PURIFIER

for generating grade 99.999999% UHP carrier gas for GC from Helium grade 99.999%

RESULTS:

Chromatogram : Trace H2-O2-CH4 impurities in N2O

Peak	Unit	Calibration Value	Area Counts
H2	ppm	5.69	28374
CH4	ppm	5.90	94297
O2	ppm	4.94	35973

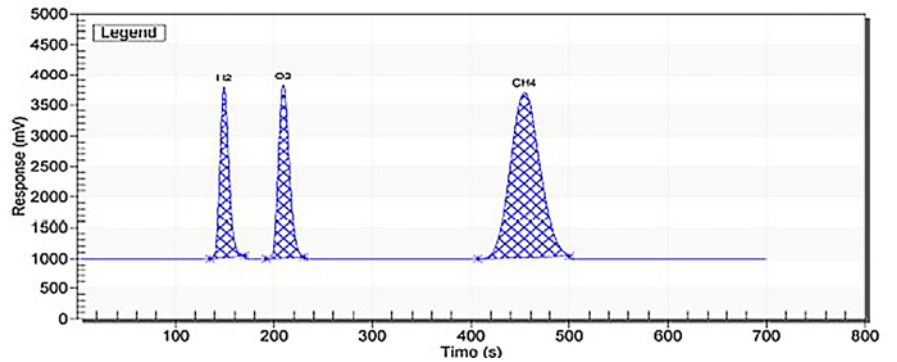

Chromatogram : Trace N2 impurities in N2O

Peak	Unit	Calibration Value	Area Counts
N2	ppm	5.36	39445

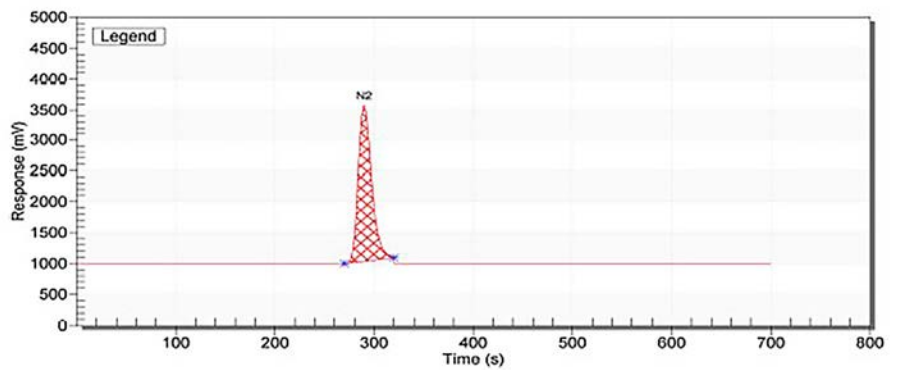

Chromatogram : Trace CO impurities in N2O

Peak	Unit	Calibration Value	Area Counts
CO	ppm	5.32	34990

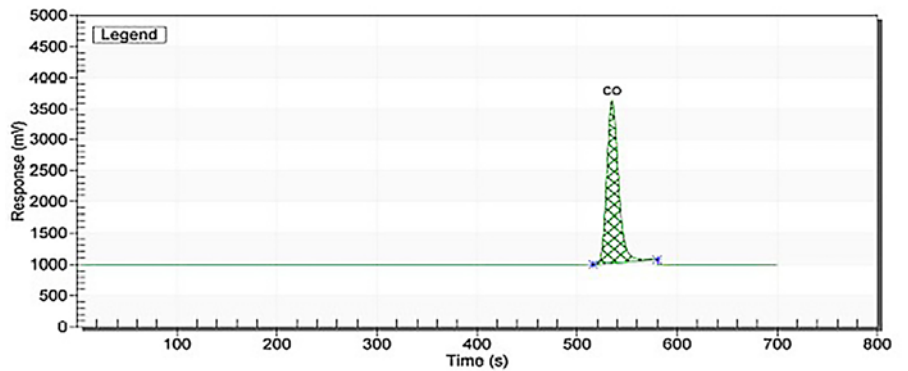

Chromatogram : Trace Ar impurities in N2O

Peak	Unit	Calibration Value	Area Counts
Ar	ppm	4.65	31373

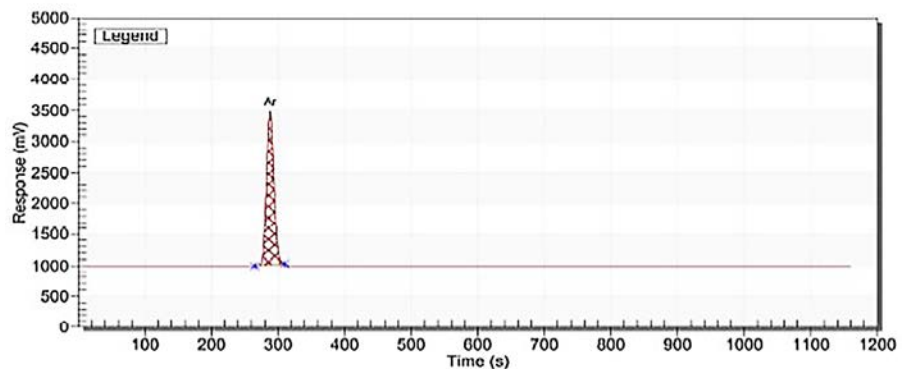

Chromatogram : Trace Ne impurities in N2O

Peak	Unit	Calibration Value	Area Counts
Ne	ppm	4.86	9891

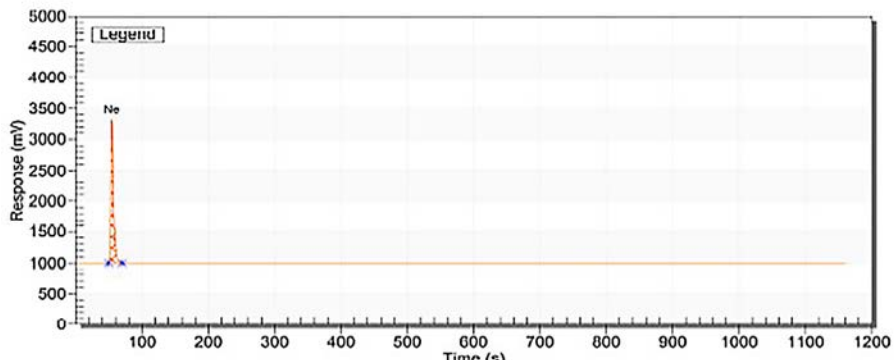
**Chromatogram : Trace C2H2-C2H4-C2H6 impurities in N2O**

Peak	Unit	Calibration Value	Area Counts
C2H2	ppm	3.72	60461
C2H4	ppm	4.62	107184
C2H6	ppm	4.55	151170

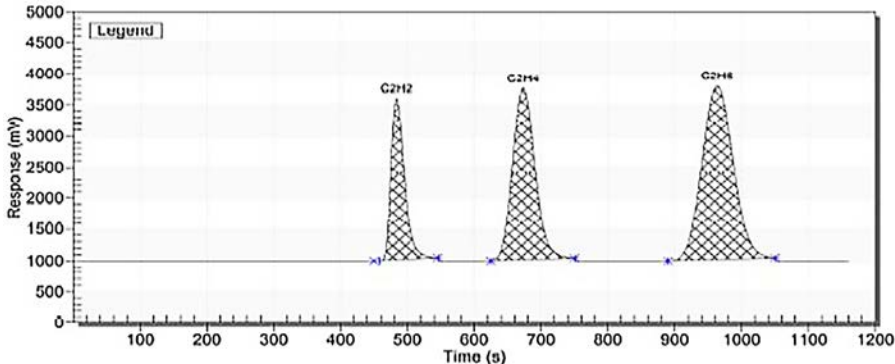
**LIMIT OF DETECTION**

COMPONENTS	CONCENTRATION	PEAK HEIGHT	NOISE	LDL (3X NOISE)
H2	0.05 ppm	30 mV	2.0 mV	10 ppb
O2	0.053 ppm	30 mV	2.0 mV	10.6 ppb
N2	0.05 ppm	24 mV	1.5 mV	9.3 ppb
CH4	0.05 ppm	33 mV	2.0 mV	9.0 ppb
CO	0.05 ppm	25 mV	2.0 mV	12.0 ppb

Note: other LDL could be obtained with different injection volume and chromatographic condition

For the Idl of the impurities Ar-Ne-C2H2-C2H4-C2H6, they don't appear in the chart since the results are based on the O2 and CH4 which use the same sensor on the PlasmaDetek2. The Idl is then evaluate at 10ppb for Ar-Ne and 9ppb for C2s.

H2 : 0.05ppm

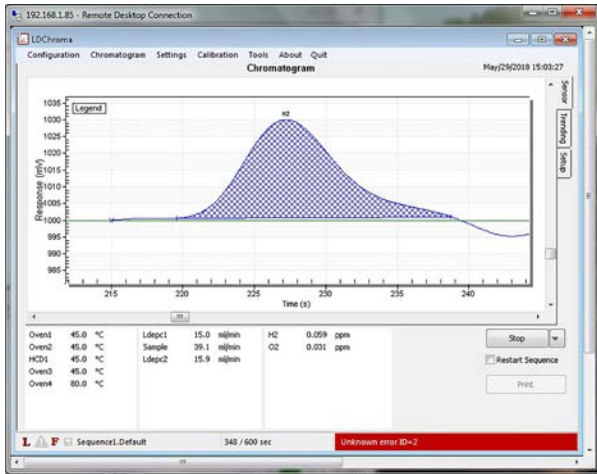

O2 : 0.053ppm

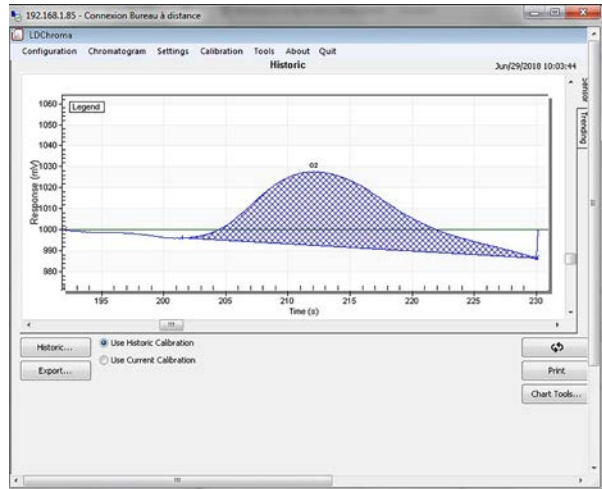

N2 : 0.05ppm

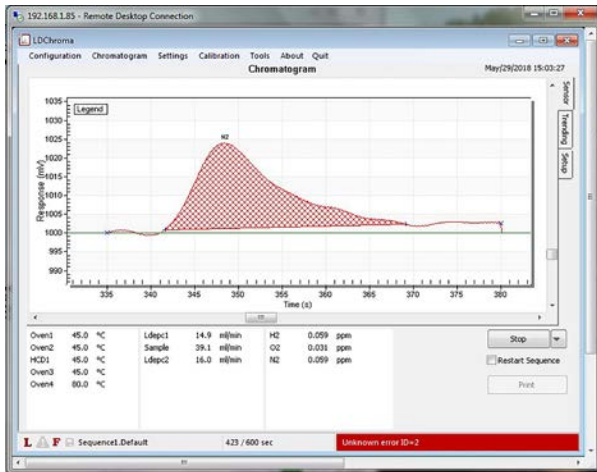

CH4 : 0.05ppm

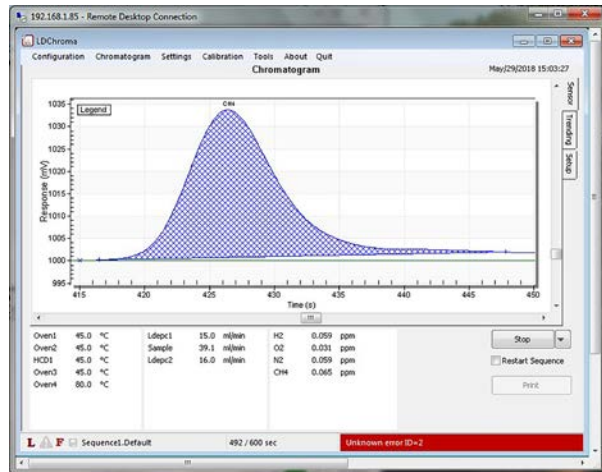

CO : 0.05ppm

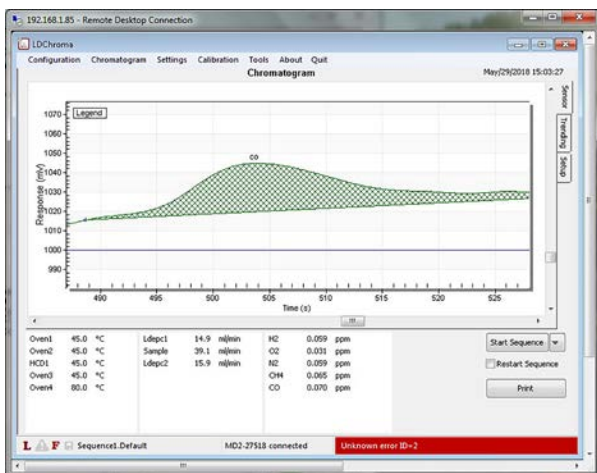

Repeatability to be at a value of $CV\% \times 3 < 5\%$ for a series of consecutive analysis at a fix concentration in a balance gas of nitrous oxide.

COMPONENTS	Repeatability (CV% x 3)
H2	1.64%
O2	0.73%
N2	1.56%
CH4	2.05%
CO	1.66%

For the repeatability of the impurities Ar-Ne-C2H2-C2H4-C2H6, they don't appear in the chart since the results are based on the O2 and CH4 which use the same sensor on the PlasmaDetek2. An evaluation of 0.73% for Ar-Ne and 2.05% for C2s is given.

Results (screenshot) of consecutive analysis at a fix concentration for H2-N2-CH4-CO impurities in balance N2O

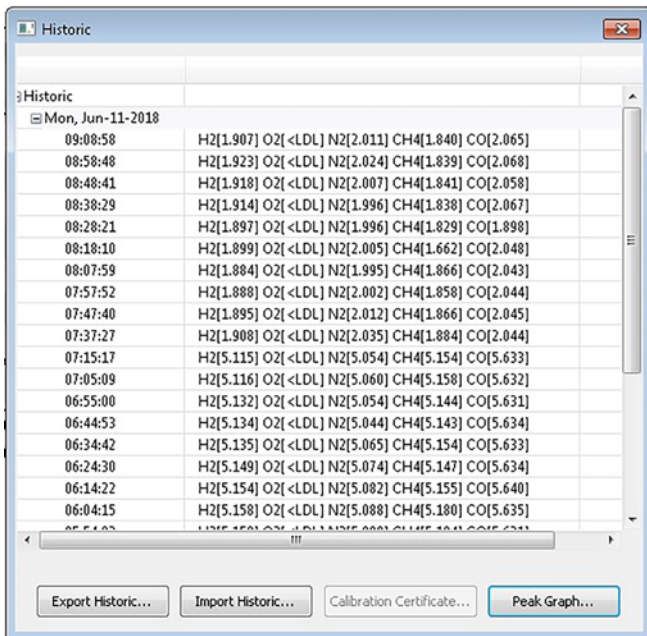

Results (screenshot) of consecutive analysis at a fix concentration for O2 impurity in balance N2O

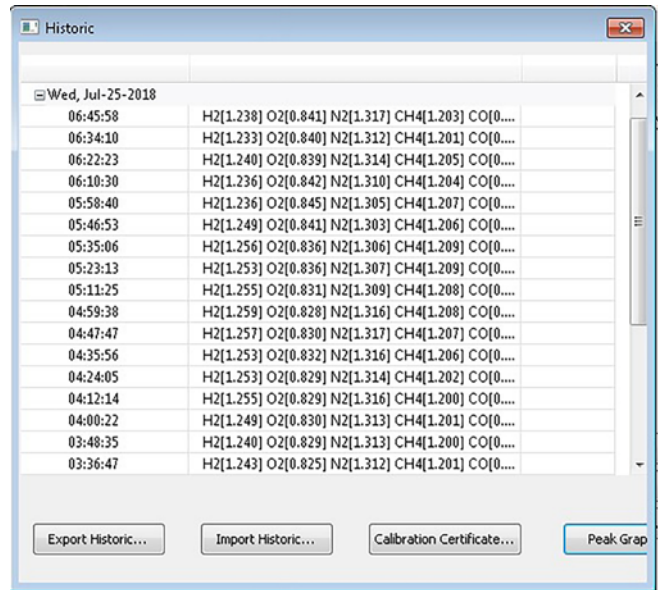

CONCLUSION:

Using one PlasmaDetek2 detector inside one unit MultiDetek2 GC, the analysis of trace ppb/ppm impurities H2-O2-N2-CH4-CO-CO2 with addition of Ar-Ne and addition of C2H2-C2H4-C2H6 have been measured. The analysis time for the impurities H2-O2-N2-CH4-CO-CO2 in UHP N2O was realized within 13 minutes. By adding the analysis of Ar-N2-C2H2-C2H4-C2H6 on top of the other impurities listed, the analysis time was realized in 20 minutes. The MultiDetek2 GC was configured with helium as carrier gas, stainless steel diaphragm valve and capillary MXT type columns to minimize the carrier flow consumption. The unit is using 4-20mA outputs for each impurity and also the Modbus protocol for transmitting the data's. The GC and the stream selector system LDGSS are both remotely controlled by the Ethernet port. Meaning that the calibration of the units can be performed remotely.

The complete integration of the system has been made inside a standard rackmount enclosure. The instruments from Tiger Optics and from MKS have been added for the analysis of H2O and NOx-NH3 respectively.

APPLICATION NOTE

LD20-03



MultiDetek2 gas chromatograph with PlasmaDetek2 detector uses for the analysis of semiconductor specialty gases as UHP Octafluorocyclobutane (C₄F₈)



Octafluorocyclobutane, or perfluorocyclobutane, C₄F₈, is a compound of carbon and fluorine used in the production and processing of semiconductor materials and devices, for example as a deposition gas and etchant. Production of such high purity specialty gas then requires a quality control analyser.

LDETEK SOLUTION:

Measuring the production quality of complex electronic specialty gases as C₄F₈ uses as etchant can be realized with our gas chromatograph MultiDetek2.

Our system uses PlasmaDetek2 (PED) as detection device to ensure good selectivity and sensitivity down to sub ppb level.

Multiple purged diaphragm valves ensure the leak integrity to keep the purity of the system in place for ppb detection. The column selection is adapted to CF gases to keep the reactivity and adsorption as low as possible to ensure the stability of the results. The complete flow path of the unit is coated with inert material to eliminate the reactivity for such complex electronic gas mixtures.

Sample composition of (C4F8):

IMPURITIES	RANGE	SYSTEM LDL	SYSTEM LOQ
C ₅ F ₈	0-100 ppm	25 ppb	75 ppb
C ₂ F ₆	0-100 ppm	25 ppb	75 ppb
C ₃ F ₈	0-100 ppm	25 ppb	75 ppb
CF ₄	0-100 ppm	25 ppb	75 ppb
CO ₂	0-100 ppm	25 ppb	75 ppb
C ₄ F ₆	0-100 ppm	25 ppb	75 ppb
C ₄ F ₈	100 %	--	--

RESULTS

Chromatogram of trace ppm impurities C5F8, C2F6, C3F8, CF4, CO2 and C4F6 in Octafluorocyclobutane (C4F8) sample gas

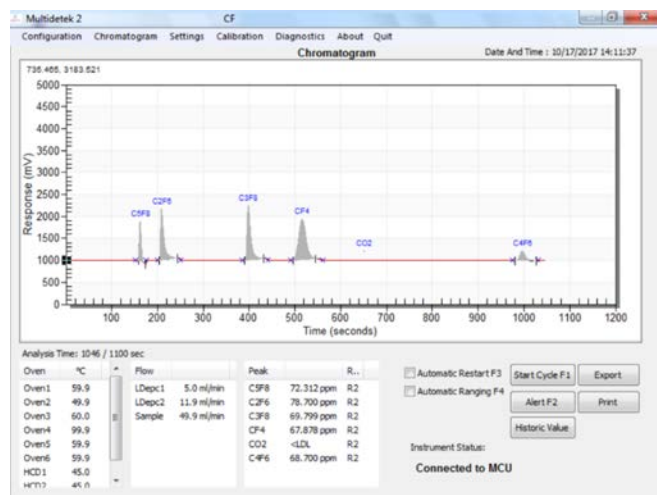

COMPONENT	CONCENTRATION	PEAK HEIGHT	NOISE	LDL (3X NOISE)
C ₅ F ₈	72.312 ppm	891 mV	0.11 mV	26.7 ppb
C ₂ F ₆	78.700 ppm	1289 mV	0.15 mV	27.4 ppb
C ₃ F ₈	69.799 ppm	1371 mV	0.15 mV	22.9 ppb
CF ₄	67.878 ppm	960 mV	0.11 mV	23.3 ppb
C ₄ F ₆	68.700 ppm	249 mV	0.04 mV	33.1 ppb

Note: other LDL could be obtained with different injection volume and chromatographic condition

CONCLUSION:

The MultiDetek2 gas chromatograph uses with the PlasmaDetek2 detector offers the requirements for such type of specialty gas application. The configuration with purged diaphragm valves combined with coated inert gas flow path and columns makes the system perfectly adapted for such specialty and complex gases. The system is rackmount and compact offering a full remote control. The industrial communication protocols are all built in and must simply be selected specifically for your requirements.

APPLICATION NOTE

LD20-07



Measurement of ppt for semiconductor H₂-CO₂-NMHC-N₂-CO-CH₄ in UHP gases



■ **MultiDetek2 GC & PlasmaDetek2**
(patent #US 9,310,308 B2):
Turnkey solution with LDGDSA automatic dilution system for
ppb calibration and complete UHP sample stream selector
system with fast loop purge.

▲ LDRack rackmount cabinet

It is well known in the semiconductor industry that measuring ppb and even ppt of permanent gases in ultra high purity gases as Helium, Argon, Oxygen, Nitrogen and Hydrogen is required. Such measurement ensures quality of the product for the production of electronic components.

LDETEK SOLUTION:

Using the enhanced PlasmaDetek2 (PED) and the MultiDetek2 (GC), in combination with its LDGDSA automatic dilution system for proper calibration and the the LDGSS sample stream selector system with fast purge loops, it offers the best solution to measure down to <100ppt.

Our solution is all integrated in our rackmount cabinets with VCR and orbital welding piping to eliminate any risk of leak and dead volume.

The analysis of trace sub ppb/ppt impurities of Ar-H₂-CO₂-NMHC-N₂-CO-CH₄ can be performed in multiple gas backgrounds. This application note will show the results obtained for sub ppb trace H₂-CO₂-NMHC-N₂-CO-CH₄ in Argon-Helium-Oxygen.

To achieve a detection limit down to <100ppt, few parameters have been developed and introduced into our analytical tools :

1 Like shown here, orbital welding is used in our solution.

2 A low pressure and a high pressure individual vent pipes have been installed to separate the detector vents from the other vents to remove the undesired backpressure signal fluctuations in the detector.

3 The actuation gas has been separated from the carrier gas to avoid any risk of pressure changes during the valve actuation, this usually resulting in some slight signal baseline fluctuations.

4 Introduction of a new injection technique resulting in balancing the sample pressure in the sample loops equal to the column head pressure eliminating the pressure drops during the injection. This technique also gives the benefit of increasing the analytes volume in the loops increasing the emission response of each impurity in the detector. In order to maintain a perfectly balanced pressure inside the loops to ensure the pressure stability of the system, a LDEPC (electronic pressure controller) has been mounted in a bypass position at the outlet of the loops just before the static orifice used for maintaining the sample flow rate. This piece of equipment maintain the pressure stable and is controllable in case of column head pressure change. That LDEPC also brings the benefit of offering a faster response time between each stream switch by having a fast loop bypass mode capable of purging up to 1 LPM. This system offers a full remote control and has no component inline with its sample flow path offering the best configuration to keep the purity of the sample gas.

5 Generating grade 10.0 (99.99999999%) Helium carrier gas is the key when measuring 100ppt is required. Our latest Large and X-Large LDP1000 gas purifier series are designed for it. Having electropolished stainless steel 316L surface, 1 micron particle filters and twin beds of mixed pellets/powder to ensure proper passage time delay to purify and remove impurities down to a maximum of 100ppt. Oversizing the adsorbant is the key here.





6 Proper span calibration is required at ppt level. The LDGDSA automatic dilution system is designed for it. Bypass flow control to avoid contamination of zero and span. Electronic pressure regulator to maintain an accurate pressure on the span/zero and the blended outlet. Again, our LDP1000 gas purifier series is used in to generate grade 10 Helium zero reference gas.

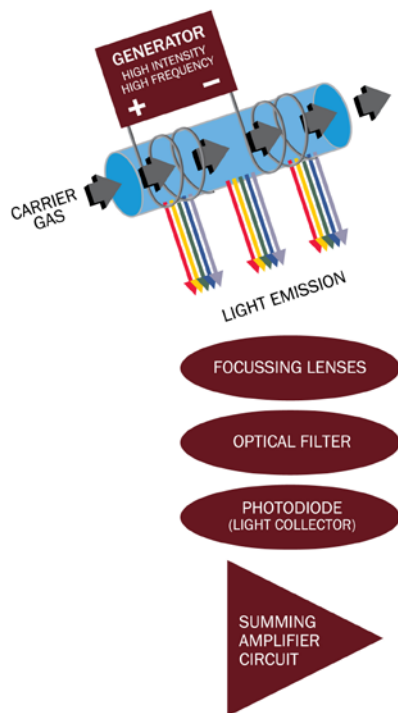

7 The MultiDetek2 system detection technology is based on the enhanced plasma emission detector (PlasmaDetek2). The specific configuration of the plasma detector used, allows a selective and sensitive detection of the desired impurities by measuring its spectral emission using a series of high response interference filters all with a narrow band. In order to increase its response, a summing optical device system has been added. By summing the emission response, a significant gain in the sensitivity can be done.

8 The route to a ppt analytical tool also included the isolation and the temperature control of the MultiDetek2. By having an internal environment controlled at a stable temperature, the stability of the results are outstanding.

RESULTS:

This document demonstrates the performances of the system by showing chromatograms obtained at low ppb concentration to show the real peak shapes, results and system performances. The results have been used to extract the limit of detection of our MultiDetek2 system. Our tests have been performed using our LDGDSA gas dilution system to generate real low ppb concentrations.

Refer to chart 1 and 2 for all IdI details.

SAMPLE GASES		IMPURITIES						
Methods	Range	Ar(IdI)	H2(IdI)	CO2(IdI)	NMHC(IdI)	N2(IdI)	CO(IdI)	CH4(IdI)
Helium	0-500ppb	80ppt	95ppt	95ppt	100ppt	85ppt	95ppt	95ppt
Argon	0-500ppb	n/a	100ppt	95ppt	100ppt	95ppt	95ppt	95ppt
Oxygen	0-500ppb	80ppt	100ppt	100ppt	100ppt	100ppt	100ppt	100ppt
Hydrogen	0-500ppb	95ppt	n/a	95ppt	100ppt	90ppt	95ppt	95ppt
Nitrogen	0-500ppb	80ppt	95ppt	95ppt	100ppt	n/a	95ppt	100ppt

Chart 1

Chromatogram at 500ppb of the impurities H2-CO2-NMHC-N2-CO-CH4



Chromatogram at 10ppb of the impurities H2-CO2-NMHC-N2-CO-CH4

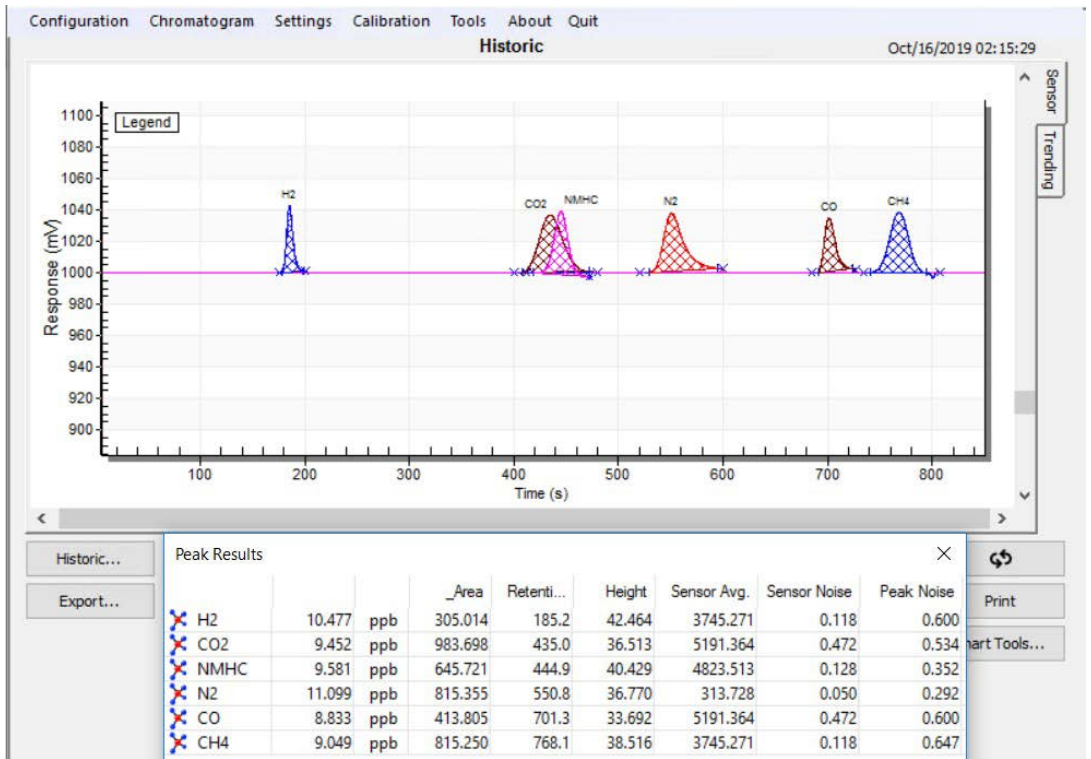

Chromatogram at 3ppb of the impurities H2-CO2-NMHC-N2-CO-CH4

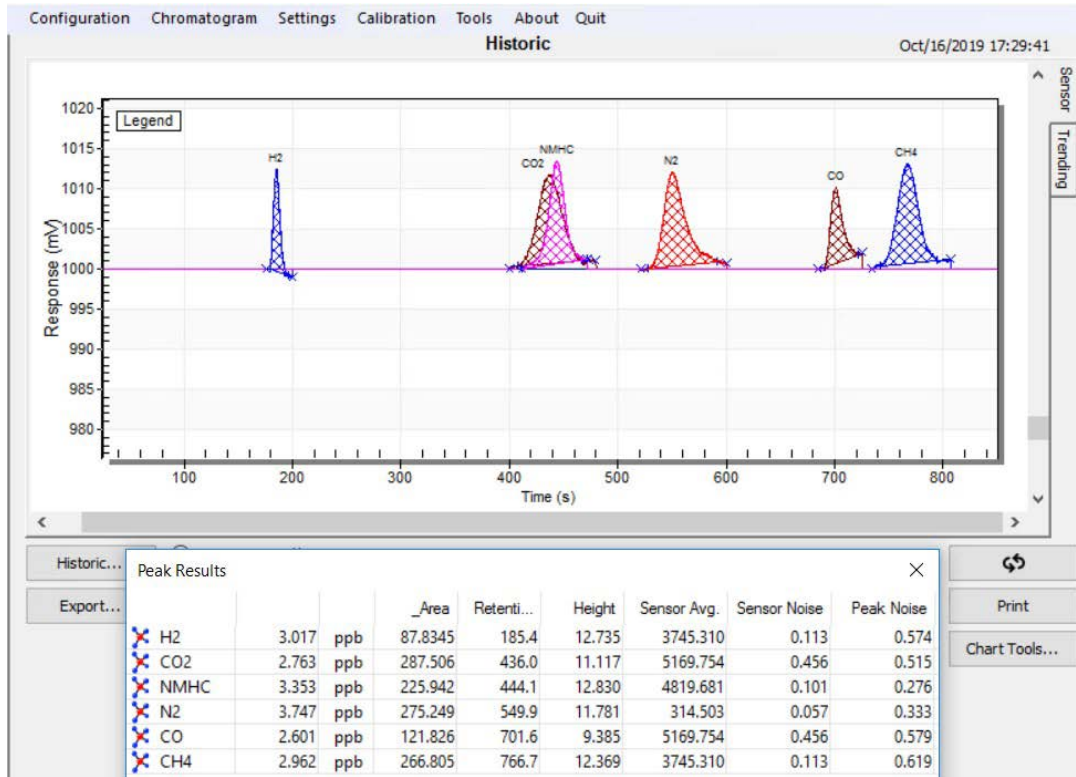

Chromatogram at 1ppb of the impurities H2-CO2-NMHC-N2-CO-CH4

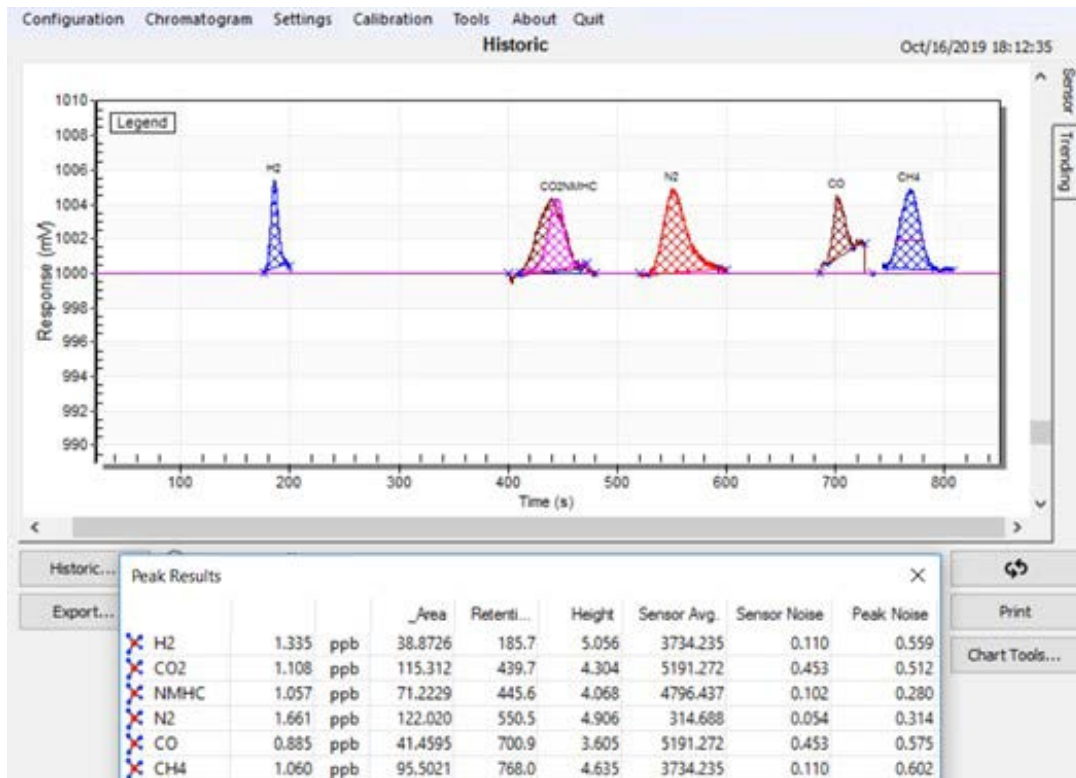

Chromatogram with an Helium blank gas

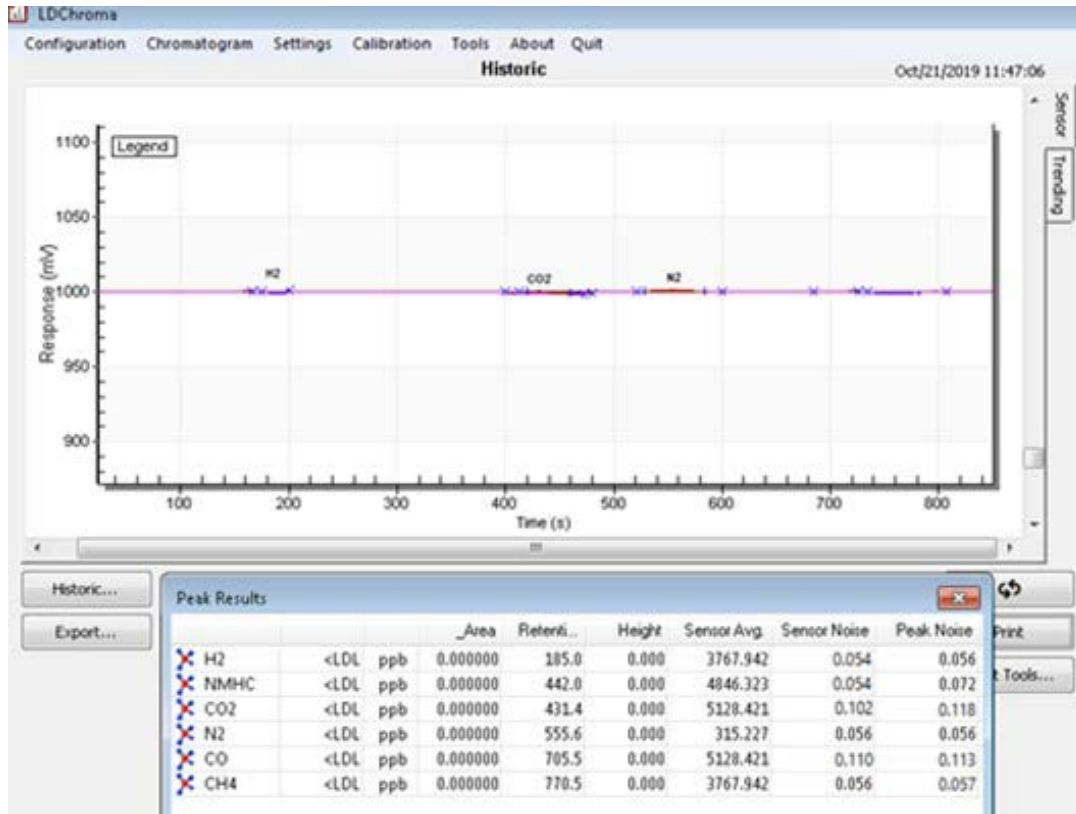

Limit of detection:

COMPONENT	CONCENTRATION (ppb)	PEAK HEIGHT (mV)	NOISE (mV)	LDL (3X NOISE) (ppt)
H2	1.335	5.056	0.056	44 ppt
CO2	1.108	4.304	0.118	91 ppt
NMHC	1.057	4.068	0.072	56 ppt
N2	1.661	4.906	0.056	57 ppt
CO	0.885	3.605	0.113	83 ppt
CH4	1.060	4.635	0.057	40 ppt

Chart 2 Note: Noise level is based on the peak noise values using an Helium blank gas

CONCLUSION:

Our complete cabinet integration with our MultiDetek2 (GC), PlasmaDetek2 (PED), LDGSS gas stream selector, LDGDSA automatic gas dilution system and our LDP1000 carrier gas purifier series are all perfectly designed and approved for the UHP semiconductor applications. With the results demonstrated, we can clearly see our systems are capable of generating and detecting very clear peaks at ppt concentrations. Don't hesitate to contact LDetek if more informations or references are required.

APPLICATION NOTE

LD21-02



Analysis of trace impurities in UHP F2-Cl2 and WF6 used for semiconductor industry with the PlasmaDetek2 and MultiDetek2 GC

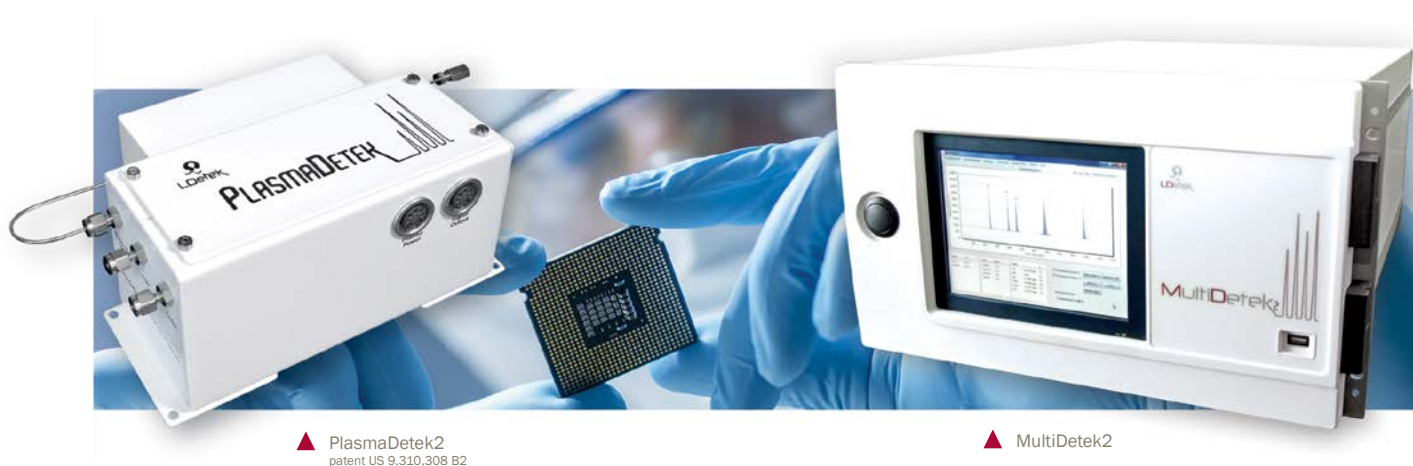

▲ PlasmaDetek2
patent US 9,310,308 B2

▲ MultiDetek2

Measuring trace impurities down to sub ppb is required by the semiconductor industry to qualify the purity of its critical UHP bulk gases Chlorine (Cl₂), Tungsten hexafluoride (WF₆) and Fluorine (F₂). These high purity gases are also employed in numerous industrial applications also requiring qualification of it prior to use.

LDETEK SOLUTION

The MultiDetek2 gas chromatograph is configured here with 2 trains. Both channels are each coupled with a PlasmaDetek2 (PED) sensor configured with the proper optical configuration to selectively measure the selected impurities. One train is used for the analysis of H₂-O₂-N₂-CH₄-CO while the second train is used for the analysis of CO₂ and SF₆.

Working here with some aggressive and reactive sample gases (Cl₂-WF₆-F₂), the separation columns and the detectors mounted in each train are individually protected with a pre-column mounted in a backflush to vent configuration. The protection columns and the backflush/injection diaphragm valves are constructed with Hastelloy to be compatible with the aggressivity of the sample gas.

On top of that, the MultiDetek2 is equipped with an integrated stream selector system also constructed with Hastelloy material. The stream selector system allows to switch from stream Cl₂ to WF₆ to F₂ along to Span gas for calibration/validation purpose. An extra inlet has been added to the stream selector system to switch the sample gas going to the sample loops of the trains to the carrier gas (Helium) as source of clean sample gas. This feature is used to protect the injection valves and loops to be attack by the aggressivity of the samples to extend its lifetime and surpass the robustness of the system. By this type of configuration, we keep the corrosion and degradation of the flow path away.

Results and chromatograms are well demonstrated in the rest of this document to particularly demonstrate the sensitivity of the GC down to sub ppb by keeping the interference from the matrix gases away.

RESULTS

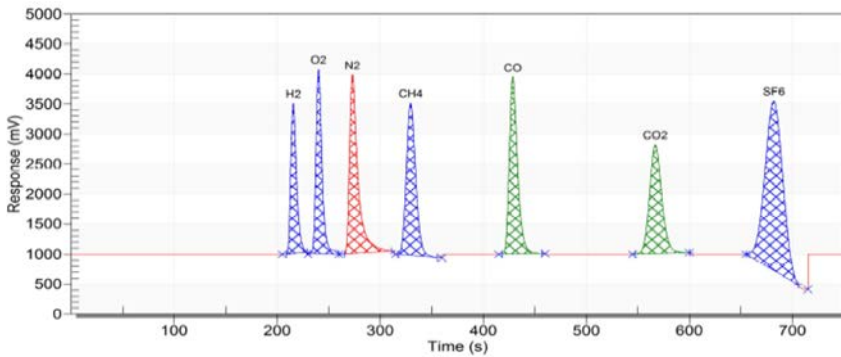

Chromatogram:
Trace H2-O2-N2-CH4-CO-CO2-SF6
impurities in Chlorine (Cl2)

Same results apply to sample gases Tungsten hexafluoride (WF6) and Fluorine (F2) using the same method and same configuration.

Limit of detection (based on 3 times the noise level from a blank)

COMPONENT	CONCENTRATION (ppb)	PEAK HEIGHT	NOISE	LDL (3X NOISE)
H2	5000	2508 mV	0.2 mV	1.2 ppb
O2	6000	3180 mV	0.2 mV	1.1 ppb
N2	6000	3007 mV	0.05 mV	0.3 ppb
CH4	5000	2509 mV	0.1 mV	0.6 ppb
CO	6000	3000 mV	0.2 mV	1.2 ppb
CO2	3650	1804 mV	0.2 mV	1.21 ppb
SF6	5000	2523 mV	0.4 mV	2.38 ppb

Note: other LDL could be obtained with different injection volume and chromatographic condition

EVALUATION OF THE NOISE LEVEL FOR EACH IMPURITY BASED ON A BLANK GAS ANALYSIS

H2 blank (0.2mV noise)

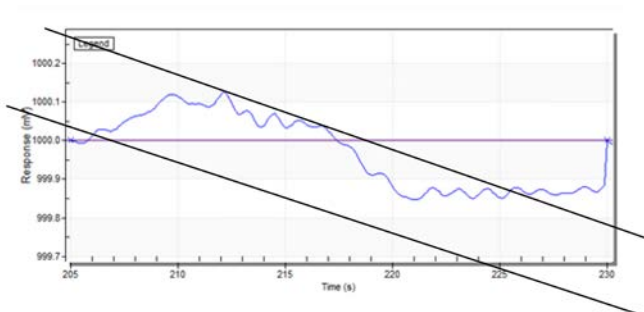

O2 blank (0.2mV noise)

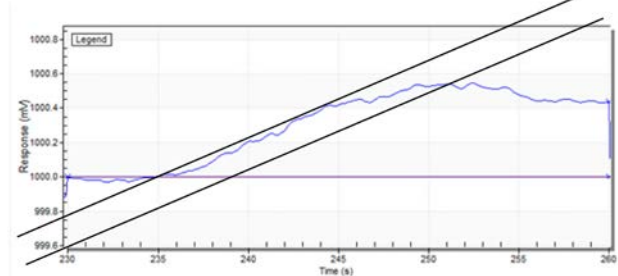

N2 blank (0.05mV noise)

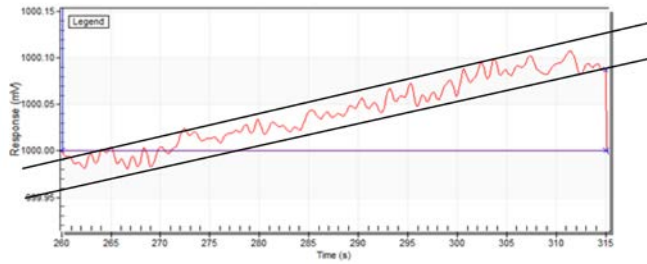

CH4 blank (0.1mV noise)

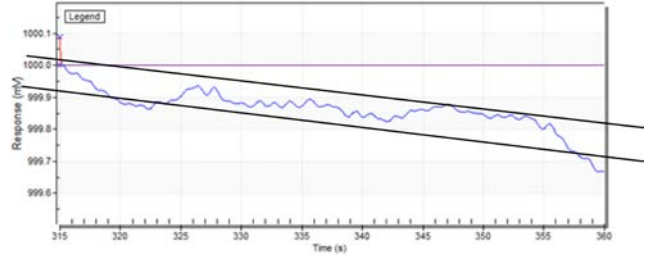

CO blank (0.2mV noise)

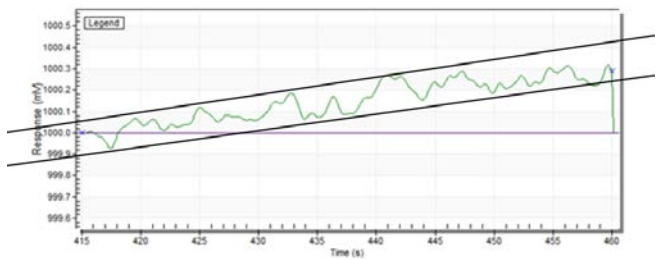

CO2 blank (0.2mV noise)

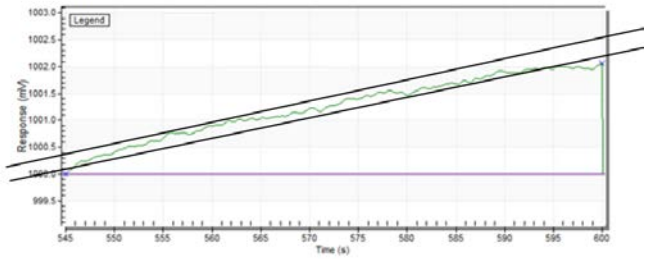

SF6 blank (0.4mV noise)

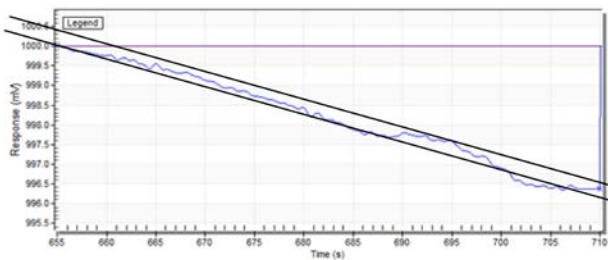

LINEARITY

By selecting 5 points within the measuring scale, being approximately 100%,75%, 50%, 10%, 0% of the scale of the instrument to be measured. The points must be generated from a certified gas bottle diluted with the same gas as the carrier gas of the instrument. Each of the 5 points is the 3th analysis result from a series of automatic analysis. The 5 points have to achieve a linear curve having its R2 at a value between 0.998 and 1.00.

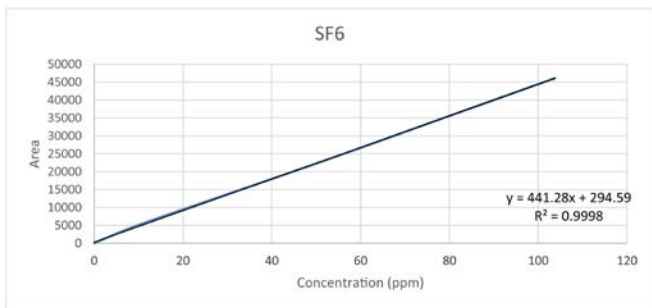
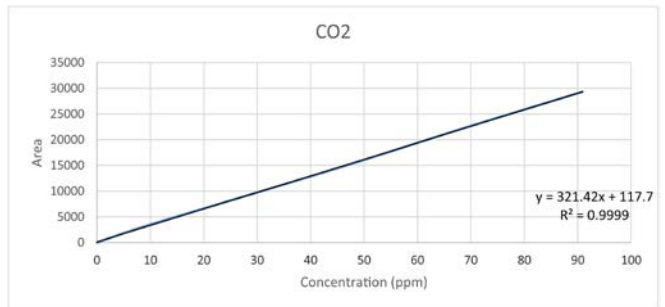
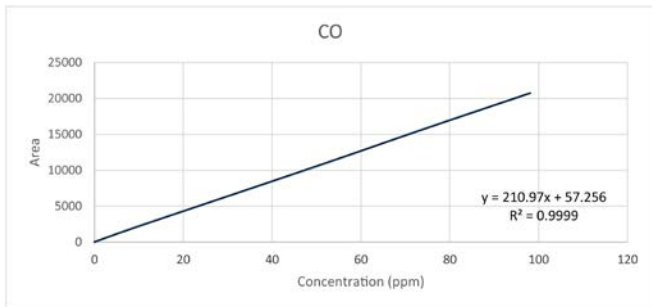
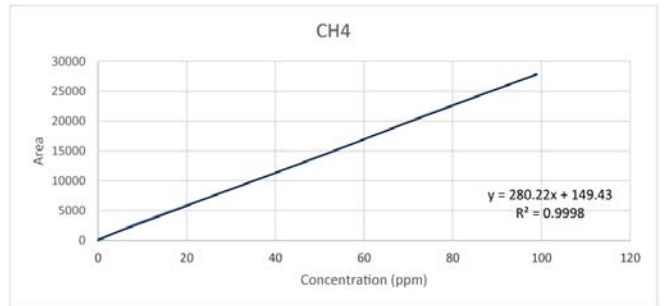
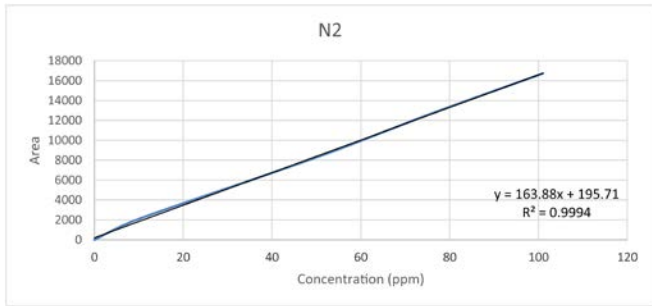
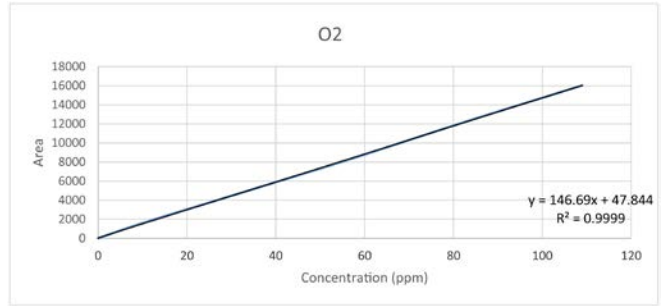
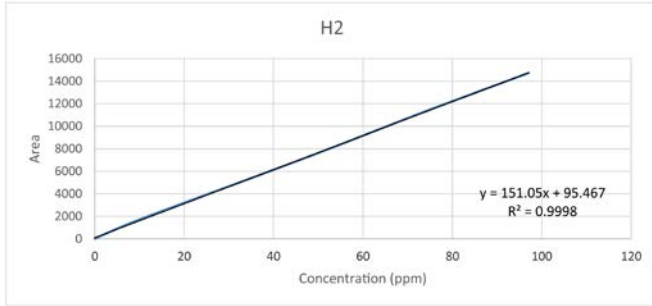

REPEATABILITY

The value of three times of the percentage of coefficient of variation ($3 \times CV \%$) of each component has to be smaller than 5%.

Peak	Average	Standard Deviation	Coefficient of Variation (%)	3 * CV (%)	Status
CH4	13.35472786 ppm	0.03073567	0.23	0.69	Accepted
CO	12.38454065 ppm	0.01509257	0.12	0.37	Accepted
CO2	11.66463355 ppm	0.01127353	0.10	0.29	Accepted
H2	13.86843651 ppm	0.06595081	0.48	1.43	Accepted
N2	23.84325036 ppm	0.05462864	0.23	0.69	Accepted
O2	17.12551940 ppm	0.04198613	0.25	0.74	Accepted
SF6	12.06071552 ppm	0.03250635	0.27	0.81	Accepted

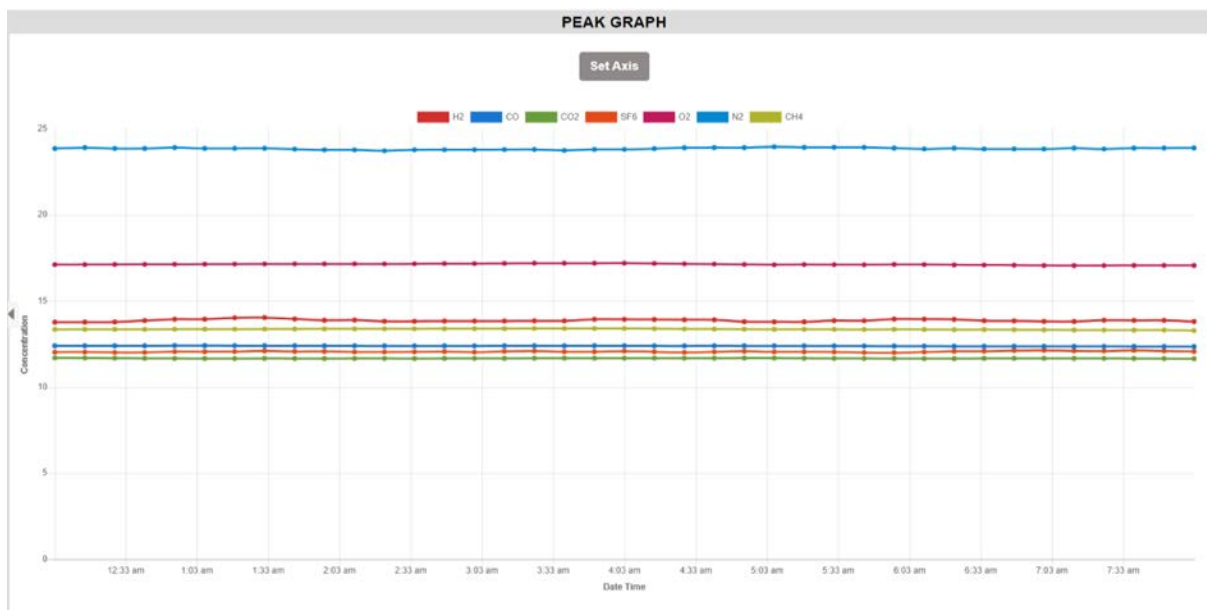

CONCLUSION

Using one PlasmaDetek2 detector inside one-unit MultiDetek2 GC, the analysis of trace ppb/ppm impurities H₂-O₂-N₂-CH₄-CO-CO₂-SF₆ in UHP grade Cl₂ and F₂ and WF₆ can be performed. The analysis time is less than 12 minutes. The unit was configured with a combination of Hastelloy and coated stainless steel valves/fittings/columns and tubing to be compatible with the aggressive nature of the sample gases. Using the proper material, the system is robust and safe to operate over years. The unit is using 4-20mA outputs for each impurity and also the Modbus protocol for transmitting the data's. Our LDGSS stream selector system has been used as well to allow switching across the different streams. The LDGSS also has been configured with Hastelloy material to be compatible with the aggressivity of the sample gases.

APPLICATION NOTE

LD22-03



Analysis of sub ppb trace impurities in UHP Oxygen



▲ MultiDetek3

▲ PlasmaDetek2
patent US 9,310,308 B2

Measuring low ppb trace impurities in controlled environment has always been required by the semiconductor manufacturing process and laboratory. Over years, the tendency is to keep improving the purity level of the manufacturing process to increase the range of uses of the electronic components produced. The detection of sub ppb impurities down to 0.1ppb is possible with the MultiDetek3 series using the micro plasma emission patented technology. Offering the modern semiconductor installations, the capacity to improve the quality and production.

LDETEK SOLUTION

The Multidetek3 industrial gas chromatograph has been configured with the plasma emission detector using Helium as carrier gas. The unit is constructed using multiple channels to allow the simultaneous analysis of sub ppb impurities H₂-CO-CO₂-NMHC-N₂-CH₄ in balance pure Oxygen. The analysis is performed in less than 13 minutes for all impurities. In case faster analysis time is required, the MultiDetek3 has the capacity to have a dual sample inlet that allow to perform parallel chromatography. In this mode, some critical impurities can be focused to be analysed very fast while the less critical impurities keep using the standard analysis time. This analysis technique with dual sample inlet, having fully independent data management/parameters offer more possibilities.

RESULTS

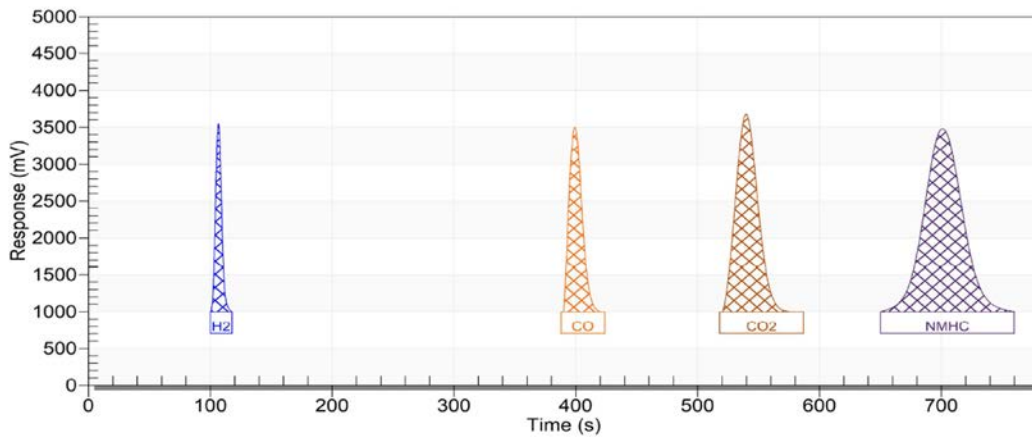

Peak	Unit	Calibration Value	_Area Counts
H ₂	ppb	508.30	2715
CO	ppb	508.30	15349
CO ₂	ppb	536.60	20795
NMHC	ppb	496.00	63598

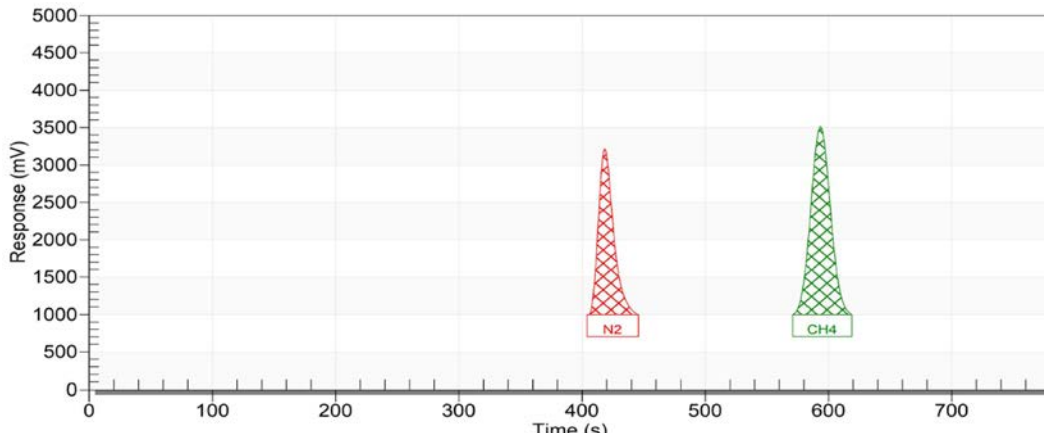

Peak	Unit	Calibration Value	_Area Counts
N ₂	ppb	444.70	4537
CH ₄	ppb	500.00	15585

Limit of detection (based on 3 times the noise level from a blank)

COMPONENTS	CONCENTRATION (ppb)	PEAK HEIGHT	NOISE	LDL (3X NOISE)
H2	508	2500mV	0.2mV	0.1ppb
CO	508	2500mV	0.2mV	0.1ppb
CO2	537	2700mV	0.2mV	0.1ppb
C3H8	496	2500mV	0.2mV	0.1ppb
N2	445	2200mV	0.2mV	0.1ppb
CH4	500	2500mV	0.2mV	0.1ppb

Note: other LDL could be obtained with different injection volume and chromatographic condition.

Stability: Based on the GC standards. Within few hours runs, being lower than 10% of 3*CV%

Peak	Average	Standard Deviation	Coef. Variation (%)	3 * CV (%)	Status
CH4	328.10233200 ppb	7.82245259	2.38	7.15	Accepted
CO	364.25439300 ppb	1.08730412	0.30	0.90	Accepted
CO2	386.59766500 ppb	2.36884334	0.61	1.84	Accepted
H2	367.41526700 ppb	1.00636241	0.27	0.82	Accepted
N2	299.84060700 ppb	3.71447400	1.24	3.72	Accepted
NMHC	358.88264700 ppb	0.40429446	0.11	0.34	Accepted

Repeatability: Based on the GC standards. Using 6 of 10 consecutive runs, being lower than 5% of 3*CV%

Peak	Average	Standard Deviation	Coef. Variation (%)	3 * CV (%)	Status
CH4	326.43002500 ppb	1.90480140	0.58	1.75	Accepted
CO	365.00640000 ppb	0.51991522	0.14	0.43	Accepted
CO2	385.48400667 ppb	2.04753965	0.53	1.59	Accepted
H2	366.82781667 ppb	0.47376130	0.13	0.39	Accepted
N2	297.41186667 ppb	1.53133150	0.51	1.54	Accepted
NMHC	358.65457167 ppb	0.16465685	0.05	0.14	Accepted

Results for 6 of 10 consecutive analyses

Start Date	H2	CO	N2	CO2	CH4	NMHC
2022-08-16 16:38	366.103 ppb	364.882 ppb	294.446 ppb	387.676 ppb	323.580 ppb	358.442 ppb
2022-08-16 16:25	366.455 ppb	364.947 ppb	297.718 ppb	388.289 ppb	326.671 ppb	358.504 ppb
2022-08-16 16:12	366.926 ppb	365.649 ppb	298.616 ppb	383.961 ppb	328.650 ppb	358.651 ppb
2022-08-16 15:58	366.923 ppb	365.600 ppb	298.494 ppb	383.229 ppb	328.380 ppb	358.668 ppb
2022-08-16 15:45	367.157 ppb	364.557 ppb	297.330 ppb	385.139 ppb	325.565 ppb	358.782 ppb
2022-08-16 15:32	367.403 ppb	364.402 ppb	297.867 ppb	384.609 ppb	325.736 ppb	358.881 ppb

CONCLUSION

The MultiDetek3 process industrial gas chromatograph configured with PED can achieve a lowest detection limit of 0.1ppb for impurities in pure Oxygen. The GC offers an integrated temperature-controlled system which allows to achieve better sensitivity and stability. The gas chromatograph comes with all standard communication protocols and data management system required by the industries. Using the dual sample inlet mode, quicker analysis can be performed when quick critical measurement is important.

APPLICATION NOTE LD23-05



Turnkey solution for ASU gas producers and SEMI applications

LDGSS gas stream selector using diaphragm stainless steel valves for ultra high purity streams

MultiDetek3 gas chromatograph configured with plasma emission detector for part per billion detections



LDGDSA gas dilution system for generating ppb calibration mixtures

LDP1000 gas purifier series used to generate grade 99.9999999% purity carrier gas to ensure low ppb detection

3.0 APPLICATION NOTES

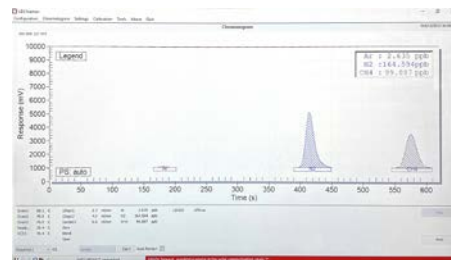
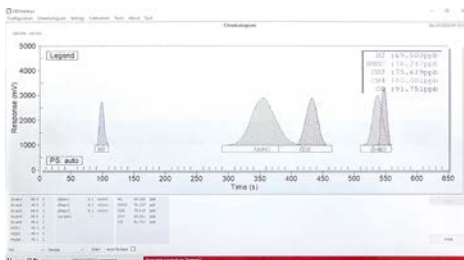

Chromatograms for trace impurities H₂-O₂-Ar-N₂-CH₄-CO-CO₂-NMHC in bulk gases Oxygen/Nitrogen used for semiconductor application. The MultiDetek3 gas chromatographs are configured with PED and proper columns to measure within a range of 0-100ppb with a limit of detection set at 0.5 ppb.

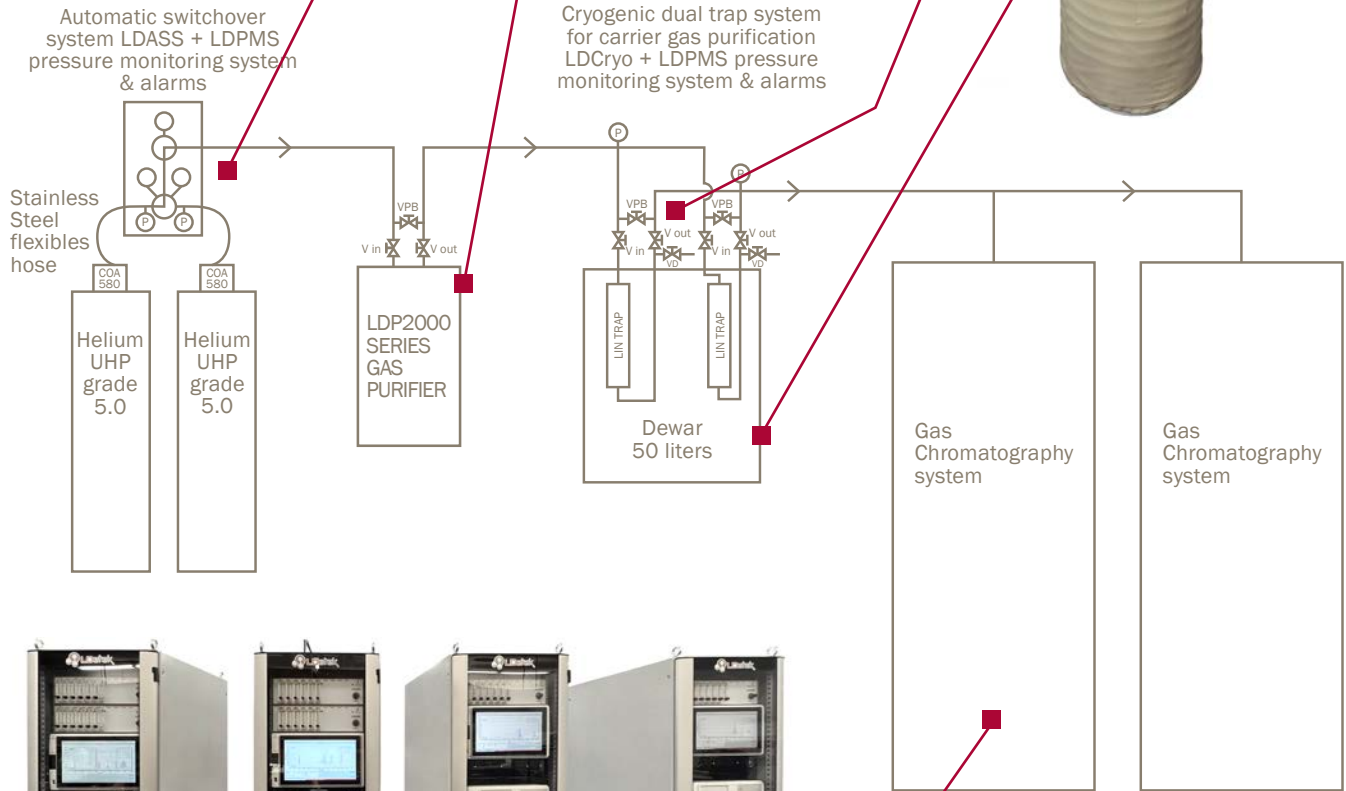
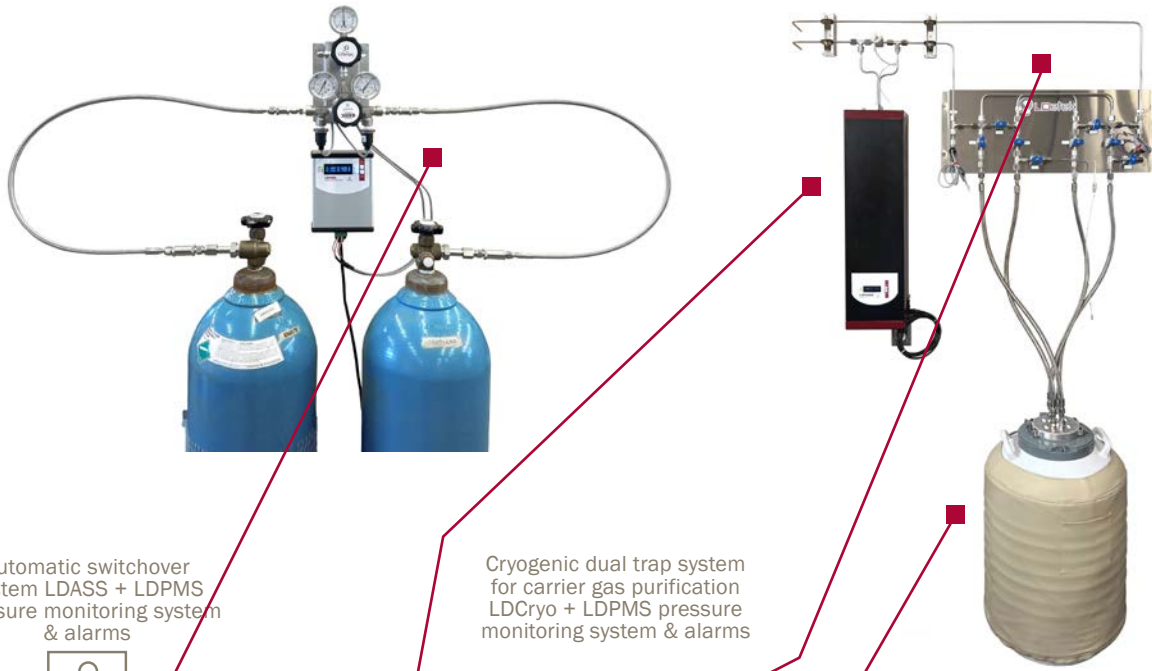

3.0 APPLICATION NOTES



3.0 APPLICATION NOTE

3.6 NATURAL GAS



3.0 APPLICATION NOTES

APPLICATION NOTE

LD15-09



Measurement of THT in natural gas using MultiDetek2 and PlasmaDetek2



▲ MultiDetek2

▲ PlasmaDetek2

A quick analysis to trace tetrahydrothiophene (THT) in natural gas is required for controlling the amount of this odorant added in the natural gas. Due to its odor, the THT is used to detect any presence of gas leakage in natural gas distribution networks. The THT is composed of a five-membered ring containing four carbon atoms and a sulfur atom. It is also known as thiophane or thiolane. The THT is generally used in mixtures containing tert-Butylthiol (TBM) which is an organosulfur compound with the formula $(\text{CH}_3)_3\text{CSH}$. In the presence of TBM in natural gas, it is required to measure its concentration at low ppb/ppm because of its strong odor that causes nausea. The permissible exposure limit (PEL) is in the range of 500ppb and it is the reason why a highly sensitive detection system is required for measuring both THT and TBM in natural gas.

LDETEK SOLUTION:

The use of a highly sensitive detection system (PlasmaDetek2) combined with a compact GC system (MultiDetek2) are required for such type of analysis where sensitivity, robustness and speed are necessary. The figure 1 shows the easy to operate 2-valve/2-column configuration used to achieve a quick analysis of THT at low ppb/ppm concentration with no interference from other gases present in natural gas. This type of configuration is straight and ensures a good stability of the measurement over time. The valves, tubing, fittings are made of coated stainless steel to ensure repeatability and durability of the system. The robustness of the injection and detection system makes this solution maintenance free on long-term operation.

According to the minimum detection limit that is required, the analysis time can vary. The figure 2 shows a chromatogram of such system having a limit of detection fixed at 31ppb. Analysis time is then fixed below 4 minutes, what is the average time generally required for this type of measurement. If quicker analysis time is requested, the system parameters can be easily modified to achieve lower cycle time analysis. That generally consists of sampling loop volume and system gain reduction to achieve a higher ppb detection limit.

The PED detection system can be configured either with Helium or Argon as carrier gas depending of the sensitivity requested. It is a unique carrier gas source with low gas consumption for cost saving.

The analysis of tert-Butylthiol (TBM) can be added in the same MultiDetek2 compact GC still using PlasmaDetek2 (PED) as the detection system.

With its built in industrial PC, the MultiDetek2 offers all the conventional communication protocols (analog output, Modbus, Profibus, RS232), data storage disk and alarms contacts required for a process GC.

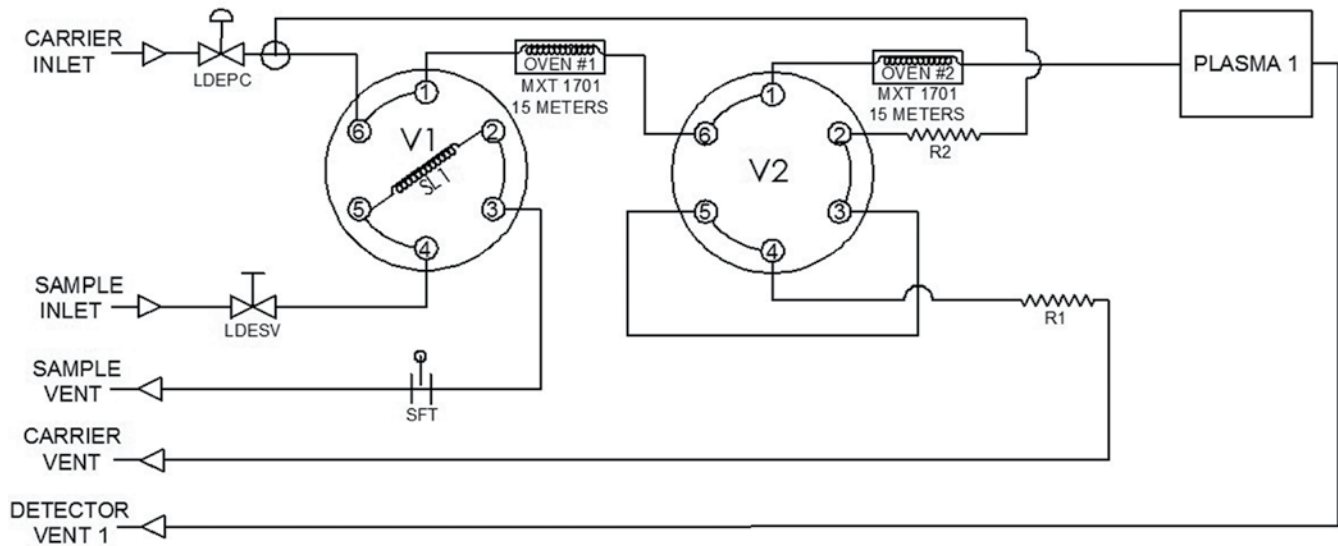

Figure 1: Application hardware configuration

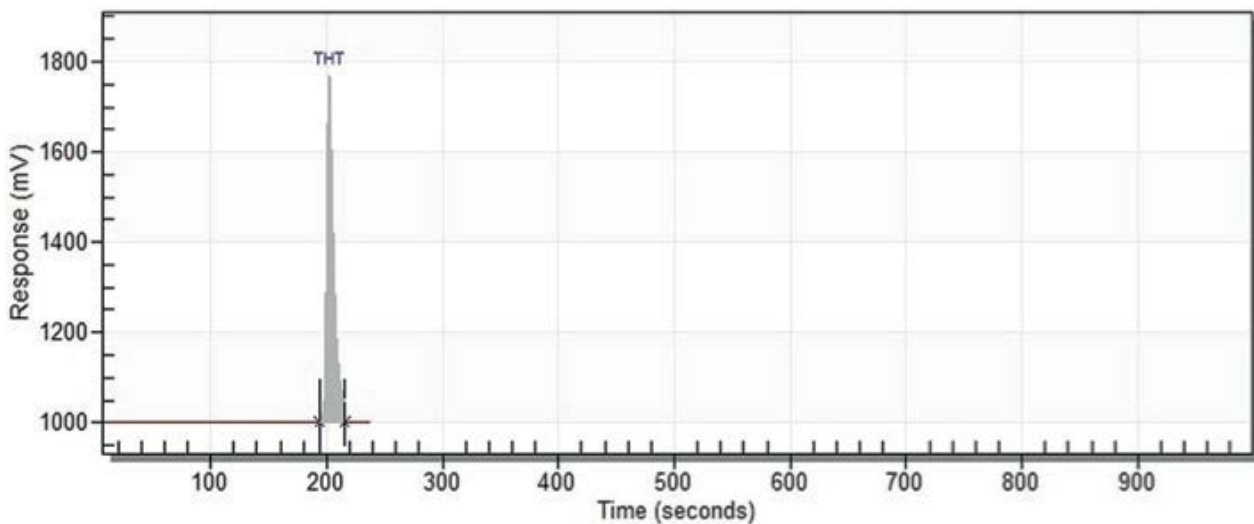

Figure 2: Chromatogram showing a standard gas containing 9.25ppm THT

Based on noise to ratio, LDL is calculated as follows:

COMPONENT	CONCENTRATION	PEAK HEIGHT	NOISE	LDL (3X NOISE)
THT	9.257 ppm	1780 mV	2 mV	0.031 ppm

Note: other LDL could be obtained with different injection volume and chromatographic conditions

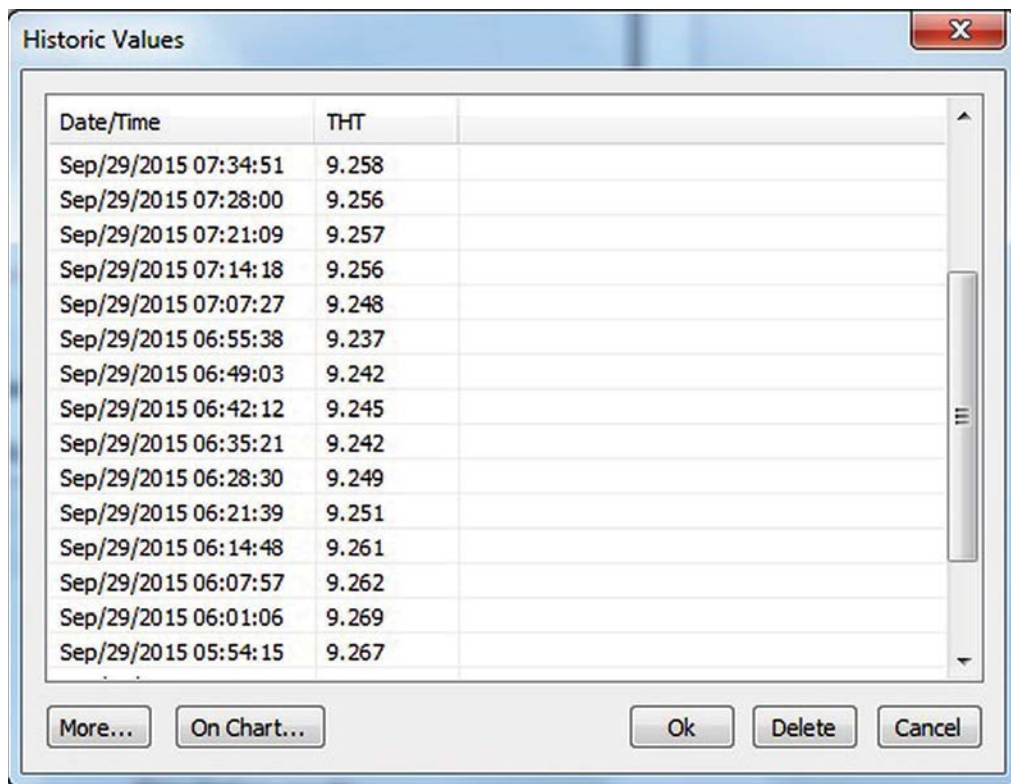

Figure 3: Historic values chart showing repeatability results better than 1% of reading

CONCLUSION:

Using a solution combining the PlasmaDetek2 and MultiDetek2 is the best way to achieve sensitivity, robustness and speed in an industrial compact system. This is exactly what is required from the natural gas industry.

APPLICATION NOTE

LD19-01



Measurement of THT-TBM odorants in natural gas using the MultiDetek 2 and PlasmaDetek 2



▲ MultiDetek2

▲ PlasmaDetek2
patent US 9,310,308 B2

The quick analysis of trace tetrahydrothiophene (THT) in LNG is required for controlling the amount of this odorant added in the natural gas. The THT is used for his smell to detect any presence of gas leakage in natural gas distribution network. The THT is generally used in mixture containing tert-Butylthiol (TBM) which is an organosulfur compound. In presence of TBM in natural gas, it is required to measure its concentration at low ppb/ppm because of its strong odor that causes nausea. The permissive expose limit (PEL) is in the range of 500ppb and it is the reason why highly sensitive detection system is required for both measuring THT and TBM in natural gas. This application note is the continuity of the previous app. Note LD15-09.

LDETEK SOLUTION:

The use of a highly sensitive detection system (PlasmaDetek2) combined with a compact GC system (MultiDetek2) are required for such type of analysis where sensitivity, robustness and speed are necessary. With its built in industrial PC, the MultiDetek2 offers all the conventional communication protocols (analog output, Modbus, Profibus, RS232/RS485), data storage capability and alarm contacts required for a process GC.

In this application note, the results of the performance are demonstrated for the quick analysis of sub ppb/ppm detection of THT and TBM in LNG. The representation of few chromatograms, the linearity, the repeatability and the limit of detection well demonstrated the capability for such type of application. One detector PlasmaDetek2 has been used. The two channels are configured with coated diaphragm valves and coated MXT capillary columns to optimize the sensitivity and the analysis time. Both channels merge together in the same PED for an optimal selectivity. By this configuration, there is no interference from any hydrocarbons presence in the sample gas.

RESULTS:

Chromatogram for 11.9ppm THT

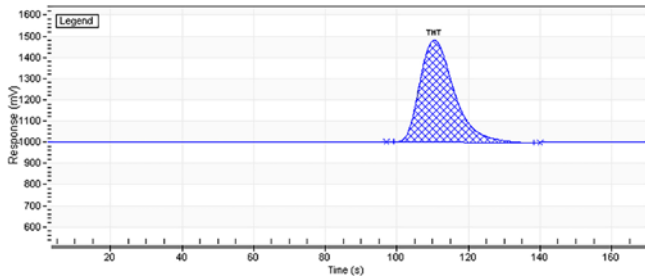

Chromatogram for 5.3ppm THT

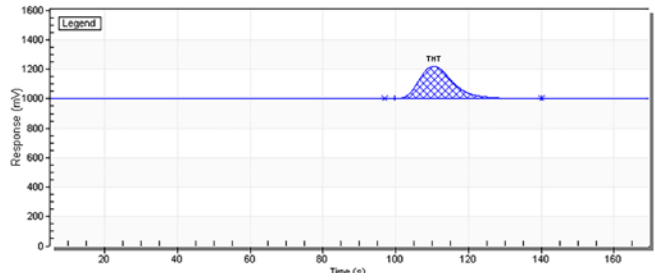

Chromatogram for 2.9ppm THT

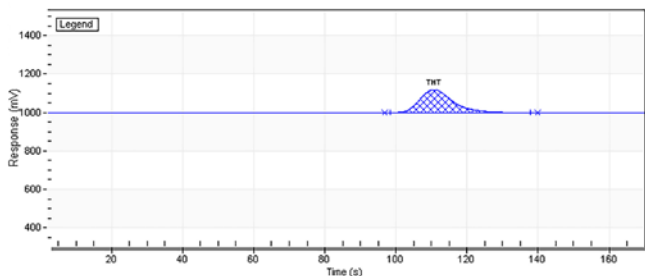

Chromatogram for 1.2ppm THT

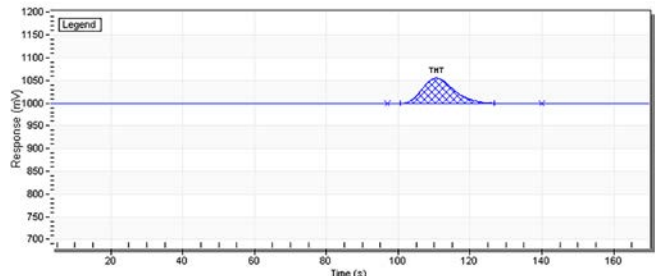

Based on the 4 chromatograms for THT, the linearity is as follow :

Impurity : THT	
Concentration	
ppm from dilution	Peak height(mV) from MD2
11.9	480
5.3	225
2.9	112
1.2	51
0	0

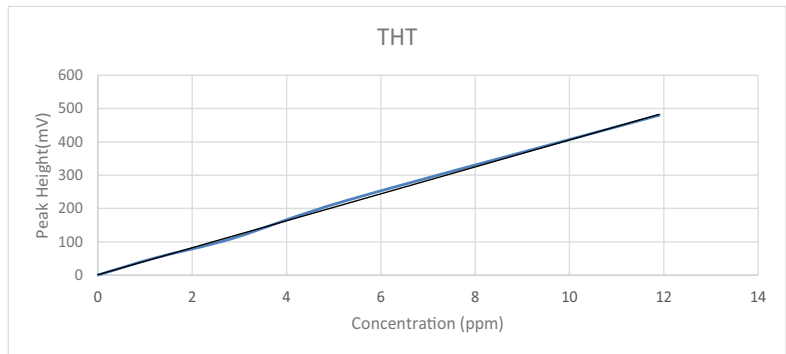

Coefficient correlation (R^2)	0.9990	Accepted
-----------------------------------	--------	----------

R^2 for 5 points within the range must be between 0.998-1.00 to be accepted

Chromatogram for 11.3ppm TBM

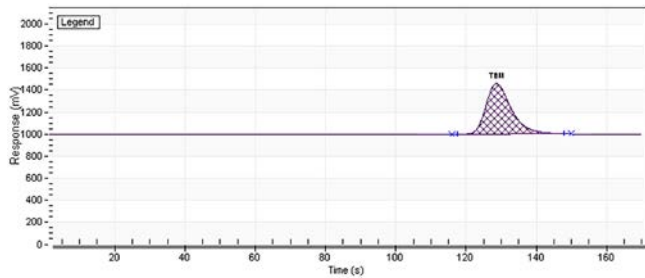

Chromatogram for 5.4ppm TBM

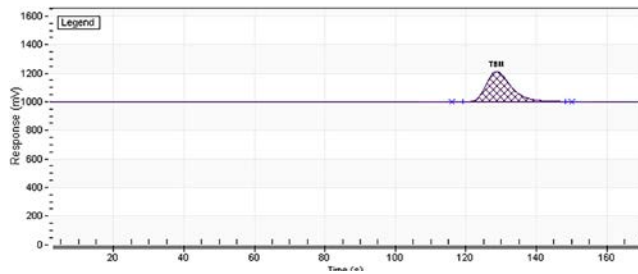

Chromatogram for 2.8ppm TBM

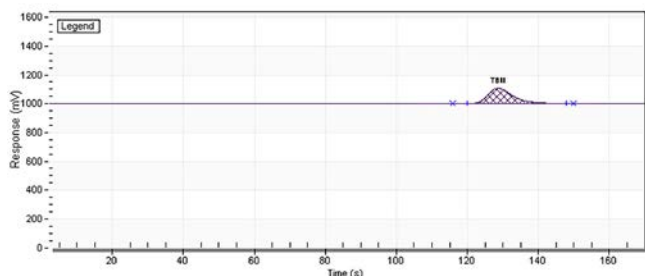

Chromatogram for 1.4ppm TBM

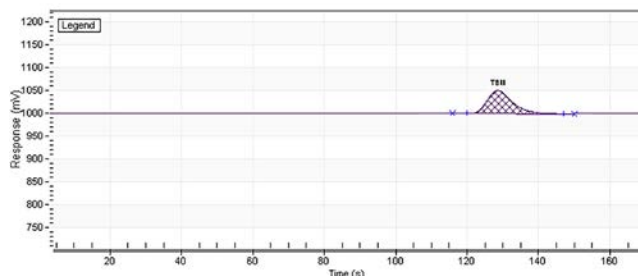

Based on the 4 chromatograms for TBM, the linearity is as follow :

Impurity : TBM	
Concentration	
ppm from dilution	Peak height(mV) from MD2
11.3	455
5.4	225
2.8	120
1.4	51
0	0

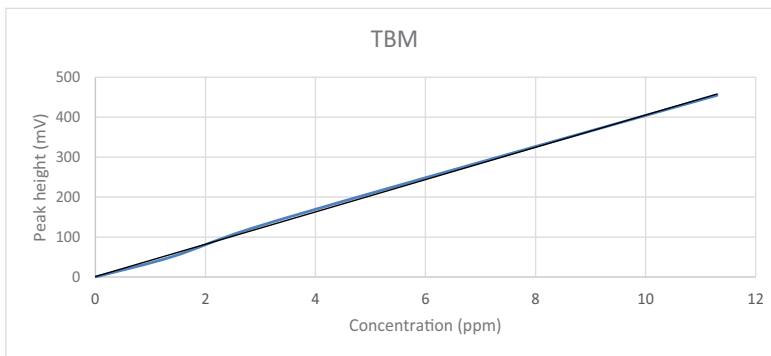

Coefficient correlation (R²)	0.9991	Accepted
--	---------------	-----------------

R² for 5 points within the range must be between 0.998-1.00 to be accepted

Repeatability for THT at a known concentration of 4.0 ppm in LNG.

Start	stream	THT	THTbis	TBM1701	TBM	TBMbis
2019-03-12 04:00		4.021 ppm			<LDL	
2019-03-12 03:57		3.942 ppm			<LDL	
2019-03-12 03:54		3.999 ppm			<LDL	
2019-03-12 03:51		4.117 ppm			<LDL	
2019-03-12 03:48		4.060 ppm			<LDL	
2019-03-12 03:45		3.980 ppm			<LDL	
2019-03-12 03:42		3.939 ppm			<LDL	
2019-03-12 03:39		4.005 ppm			<LDL	
2019-03-12 03:36		4.038 ppm			<LDL	
2019-03-12 03:33		4.077 ppm			<LDL	
2019-03-12 03:30		3.990 ppm			<LDL	
2019-03-12 03:27		4.090 ppm			<LDL	
2019-03-12 03:24		4.001 ppm			<LDL	
2019-03-12 03:21		3.988 ppm			<LDL	
2019-03-12 03:19		3.954 ppm			<LDL	
2019-03-12 03:16		4.027 ppm			<LDL	
2019-03-12 03:13		4.069 ppm			<LDL	

For an 8 hours period, the repeatability is accepted at 2.16% for CV% x 3.

Repeatability for TBM at a known concentration of 5.2 ppm in LNG.

Start	stream	THT	THTbis	TBM1701	TBM	TBMbis
2019-03-11 05:46		<LDL			5.163 ppm	
2019-03-11 05:43		<LDL			5.176 ppm	
2019-03-11 05:40		<LDL			5.201 ppm	
2019-03-11 05:37		<LDL			5.137 ppm	
2019-03-11 05:34		<LDL			5.151 ppm	
2019-03-11 05:31		<LDL			5.188 ppm	
2019-03-11 05:28		<LDL			5.196 ppm	
2019-03-11 05:25		<LDL			5.173 ppm	
2019-03-11 05:22		<LDL			5.190 ppm	
2019-03-11 05:19		<LDL			5.204 ppm	
2019-03-11 05:16		<LDL			5.205 ppm	
2019-03-11 05:14		<LDL			5.199 ppm	
2019-03-11 05:11		<LDL			5.190 ppm	
2019-03-11 05:08		<LDL			5.145 ppm	
2019-03-11 05:05		<LDL			5.175 ppm	
2019-03-11 05:02		<LDL			5.199 ppm	
2019-03-11 04:59		<LDL			5.177 ppm	

For an 8 hours period, the repeatability is accepted at 1.05% for CV% x 3.

Based on noise to ratio, LDL is calculated as follow :

COMPONENT	CONCENTRATION	PEAK HEIGHT	NOISE	LDL (3X NOISE)
THT	3.91ppm	164mV	0.4mV	28.7ppb
TBM	5.17ppm	208mV	0.3mV	22.3ppb

Note: other LDL could be obtained with different injection volume and chromatographic condition

3.91 ppm of THT measured in **channel 1**

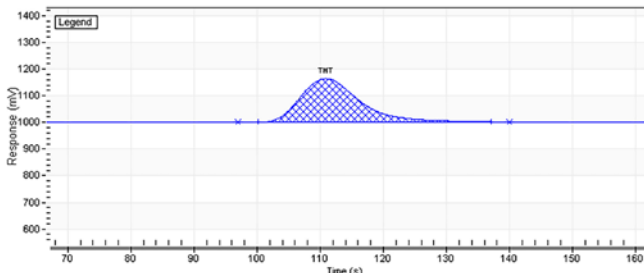

5.17ppm of TBM measured in **channel 2**

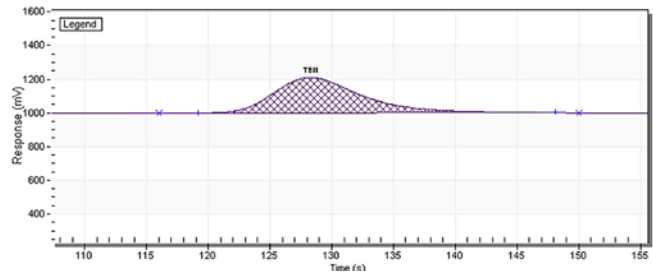

CONCLUSION:

Using a solution combining the PlasmaDetek 2 and MultiDetek 2 is the best way to achieve sensitivity, selectivity, simplicity, robustness and speed in an industrial compact system. Our solution can be used in safe zone or hazardous area. A purged version of the MultiDetek2 gas analyser is available to meet the ATEX and IECEx requirements if an ex proof solution is required.

APPLICATION NOTE

LD19-04



Measurement of sulfurs & mercaptans combined with THT-TBM in natural gas using the MultiDetek2 and PlasmaDetek2



▲ MultiDetek2

▲ PlasmaDetek2
patent US 9,310,308 B2

Natural gas is colourless and odourless in its most pure form. When extracted, it can contain sulphur compounds such as sulfurs and Mercaptans that when in the presence of moisture can produce sulphuric acid that can degrade the pipeline. So for reasons of public safety as well as pipeline integrity, there is a need to measure and control precisely the level of odorant species in natural gas:

- ▶ **Adjust the amount of sulphur molecules in the gas**
- ▶ **Control of odorant passivation**
- ▶ **Aids in detection of leaks**

This application note is the continuity of the previous app. note LD15-09 and LD19-01 where the description of the method for the detection of THT and TBM is demonstrated.

LDETEK SOLUTION:

The use of a highly sensitive detection system (PlasmaDetek2) combined with a compact GC system (MultiDetek2) is able to analyse sulfurs, mercaptans, Diethyl sulfide (DES), Dimethyl sulfide (DMS), Dimethyl disulfide (DMDS), THT and total sulphur directly without convertor. With its built in industrial PC, the MultiDetek2 offers all the conventional communication protocols (analog output, Modbus, Profibus, RS232/RS485), data storage capability and alarm contacts required for a process GC. Complete remote control of the system can be performed from the Ethernet connection available on every unit.

Our solution can be used in safe zone with our 6U standard 19" rackmount enclosure or in hazardous area with our IP66 rated 316SS wall mount purged enclosure 30"(762mm)deep x 57"(1447mm) height x 38"(965mm) width. An X-purge controller is installed to create a constant positive flow of air inside the enclosure, thus making a positive pressure inside enclosure. The purge is set to prevent toxic fumes from going inside the instrument in case of hazardous leakage.

The X-purge controller located on the top of the purged SS enclosure is configured to control the purging time requires prior to apply power to the instrument and hardware inside the box. It is also used for monitoring the purge pressure and flow rate inside the purged enclosure. In case of low purge pressure and/or flow rate, the power is shutoff instantly.

An extra safety pneumatic Swagelok VCR shut-off valve is mounted externally to the purged box on the sample inlet line to ensure the sample flow will but shut off in case of air supply pressure drops.

Internal temperature is monitored and controlled with a Vortex cooling system in case the unit isn't mounted in an air conditioned shelter. Our ATEX and IECEx solutions are certified by CSA following the standard II 2G Ex e mb ib pxb IIC T* Gb.

In this application note, the results of the performance are demonstrated for the analysis of sub ppb/ppm detection of COS-SO2-DES-DMDS-CS2-EM-DMS in natural gas. The representation of calibration chromatograms, the repeatability and the limit of detection well demonstrated the capability of our system for such type of application. One detector PlasmaDetek2 has been used. The multi channels of the MultiDetek2 GC are configured with coated diaphragm valves and coated metalized capillary columns to optimize the sensitivity and the carrier flow consumption. All channels merge together in the same PED for an optimal selectivity. More than one PED detector can be installed to allow parallel analysis and then reducing the analysis time when required. By this configuration, there is no interference coming from the other impurities present in the natural gas.

RESULTS:

Chromatogram for 10.28ppm COS in natural gas

Peak	Unit	Calibration Value	Area Counts
COS	ppm	10.28	9607

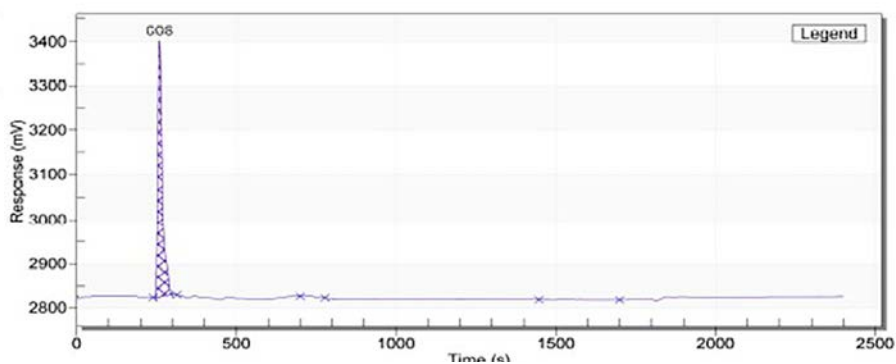

Chromatogram for 9.91ppm SO2 in natural gas

Peak	Unit	Calibration Value	Area Counts
SO2	ppm	9.91	5388

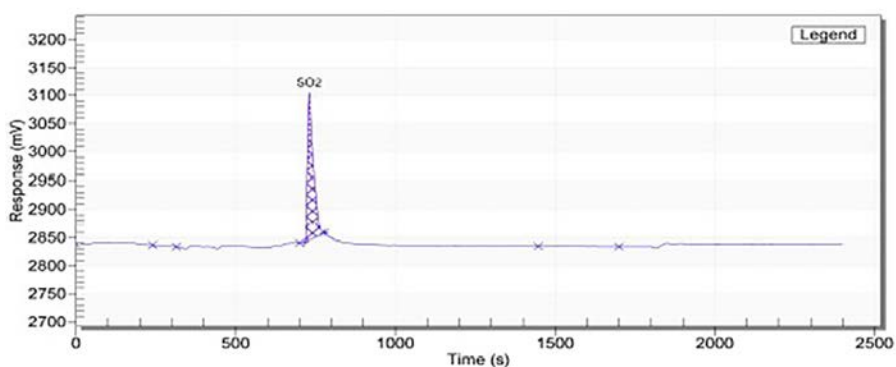

Chromatogram for 10.23ppm CS2-EM-DMS in natural gas

Peak	Unit	Calibration Value	Area Counts
CS2-EM-DMS	ppm	10.23	28361

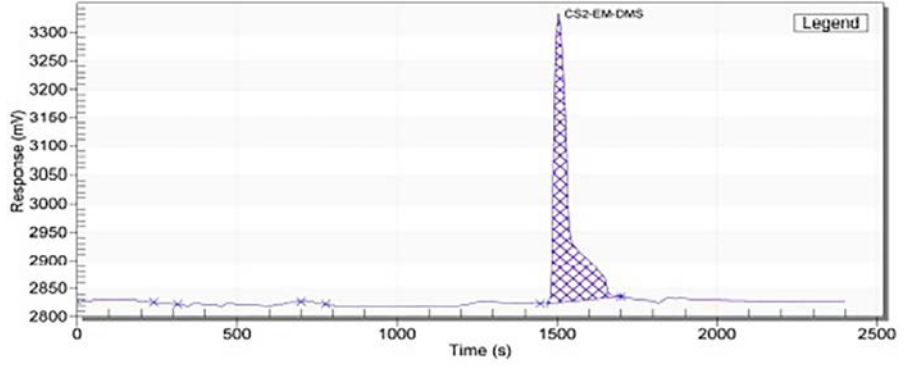

Chromatogram for 10.09ppm DES and 9.79ppm DMDS in natural gas

Peak	Unit	Calibration Value	Area Counts
DES	ppm	10.09	16864
DMDS	ppm	9.79	14983

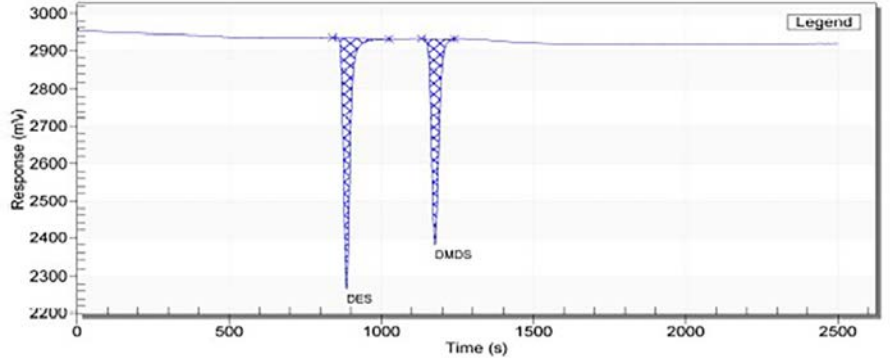

Repeatability to be at a value of $CV\% \times 3 < 5\%$ for a series of consecutive analysis at a fix concentration in a balance gas of natural gas.

COMPONENTS Repeatability (CV% x 3)

DES	3.99%
DMDS	1.69%
COS	4.66%
SO2	3.83%
CS2	2.45%
EM	2.45%
DMS	2.45%

Results for THT and TBM are documented in our application note LD19-01.

Results (screenshot) of consecutive analysis at a fix concentration of 2.25ppm for DES and 2.10ppm for DMDS impurities in balance natural gas

Time	COS	SO2	DES	DMDS
13:56:24	<LDL	<LDL	2.284	2.119
13:34:32	<LDL	<LDL	2.253	2.126
13:12:39	<LDL	<LDL	2.207	2.113
12:50:47	<LDL	<LDL	2.274	2.099
12:28:52	<LDL	<LDL	2.290	2.096
12:07:00	<LDL	<LDL	2.257	2.103
11:45:08	<LDL	<LDL	2.243	2.091
11:23:14	<LDL	<LDL	2.260	2.091
11:01:21	<LDL	<LDL	2.231	2.090
10:30:23	<LDL	<LDL	2.224	2.088

Results (screenshot) of consecutive analysis at a fix concentration of 2.10ppm for COS impurity in balance natural gas

Time	COS	SO2	DES
08:01:30	2.157	<LDL	
07:44:38	2.166	<LDL	
07:25:37	2.137		
06:45:19	2.117	<LDL	<LDL
06:05:00	2.100	<LDL	<LDL
05:24:42	2.081	<LDL	<LDL
04:44:24	2.049	<LDL	<LDL
04:04:05	2.021	<LDL	<LDL
03:23:46	2.016	<LDL	<LDL
02:43:26	1.986	<LDL	<LDL

Results (screenshot) of consecutive analysis at a fix concentration of 1.50ppm for SO2 impurity in balance natural gas

Time	CO2	SO2	DES	DMS	CS2-EM-DMS
07:19:58	<LDL	1.476	<LDL	<LDL	<LDL
06:39:39	<LDL	1.519	<LDL	<LDL	<LDL
05:59:19	<LDL	1.507	<LDL	<LDL	<LDL
05:18:59	<LDL	1.471	<LDL	<LDL	<LDL
04:38:40	<LDL	1.488	<LDL	<LDL	<LDL
03:58:19	<LDL	1.479	<LDL	<LDL	<LDL
03:18:00	<LDL	1.482	<LDL	<LDL	<LDL
02:37:40	<LDL	1.499	<LDL	<LDL	<LDL
01:57:20	<LDL	1.495	<LDL	<LDL	<LDL
01:17:00	<LDL	1.471	<LDL	<LDL	<LDL

Results (screenshot) of consecutive analysis at a fix concentration of 1.55ppm for CS2-EM-DMS impurities in balance natural gas

Time	CO2	SO2	DES	DMS	CS2-EM-DMS
16:23:39	<LDL	<LDL	<LDL	<LDL	1.571
14:20:59	<LDL	<LDL	<LDL	<LDL	1.580
13:40:39	<LDL	<LDL	<LDL	<LDL	1.563
13:00:20	<LDL	<LDL	<LDL	<LDL	1.554
12:20:00	<LDL	<LDL	<LDL	<LDL	1.588
11:39:40	<LDL	<LDL	<LDL	<LDL	1.560
10:53:10	<LDL	<LDL	<LDL	<LDL	1.605
10:12:50	<LDL	<LDL	<LDL	<LDL	1.604
09:32:30	<LDL	<LDL	<LDL	<LDL	1.597
08:52:08	<LDL	<LDL	<LDL	<LDL	1.596

Based on noise to ratio, LDL is calculated as follow :

COMPONENTS	CONCENTRATION	PEAK HEIGHT	NOISE	LDL (3X NOISE)
DES	2.28 ppm	164 mV	0.4 mV	16.7 ppb
DMS	2.11 ppm	128 mV	0.2 mV	9.9 ppb
COS	2.15 ppm	252 mV	0.3 mV	7.7 ppb
SO2	1.47 ppm	47 mV	0.2 mV	18.8 ppb
CS2	1.57 ppm	198 mV	0.4 mV	9.5 ppb
EM	1.57 ppm	198 mV	0.4 mV	9.5 ppb
DMS	1.57 ppm	198 mV	0.4 mV	9.5 ppb

Note: other LDL could be obtained with different injection volume and chromatographic condition

DES : 2.25 ppm

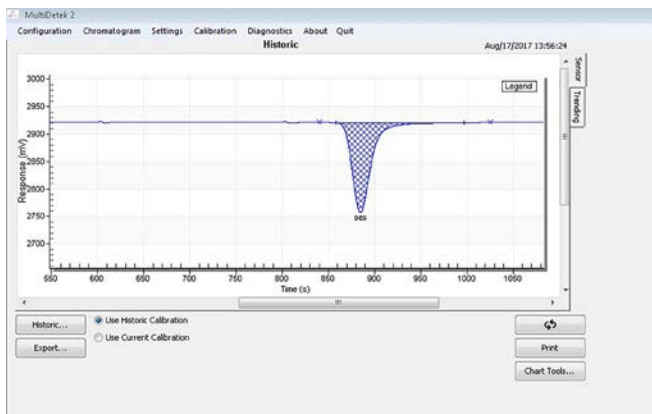

DMS : 2.11 ppm

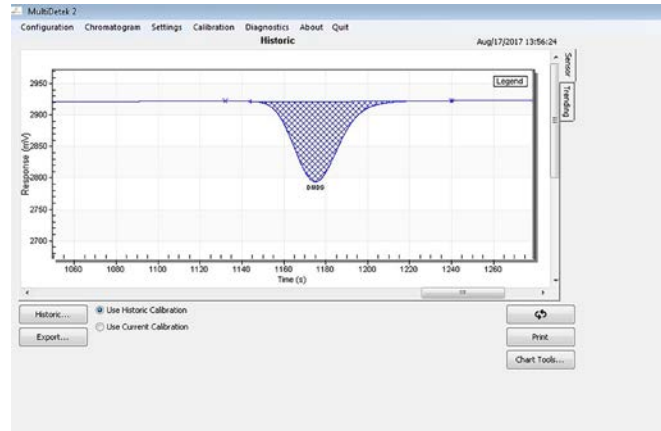

COS : 2.15 ppm

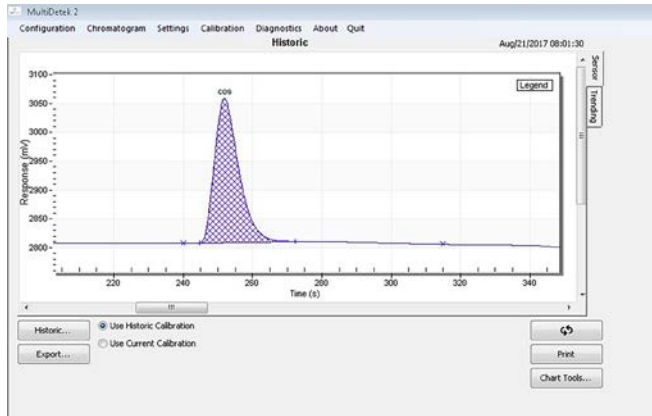

S02 : 1.47 ppm

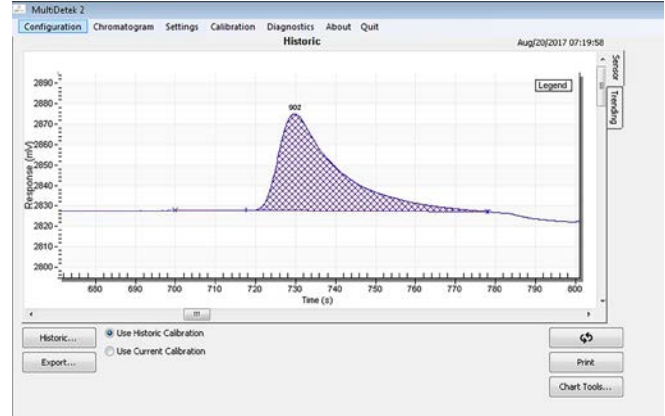

CS2-EM-DMS : 1.57 ppm

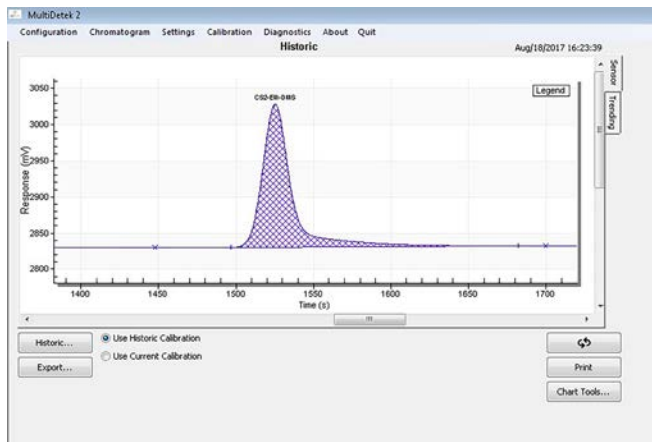

CONCLUSION:

Our MultiDetek2 GC coupled with our PlasmaDetek2 selective detector can together in one rackmount instrument measured sulfurs, mercaptans and THT-TBM in natural gas. It allows measuring all these impurities in LNG without the use of multiple detectors and accessories. The GC only requires a constant source of helium carrier gas being configured for minimum flow consumption using coated metalized capillary columns. The same instrument configuration can be used in the industry for pipeline and storage quality control. As well as process monitoring for natural gas extraction, landfill or biogas and also for delivery station for non-odorized gas as aerosol application. As describes, our instrument can be used in safe zone with its standard rackmount enclosure or in hazardous area using our wall mount IP66 rated 316 SS ATEX/IECEX certified X-purged solution.



3.0 APPLICATION NOTE

3.7 ENERGY



APPLICATION NOTE

LD16-04



Sulfur Hexafluoride (SF6) purity analysis using the MultiDetek 2 and PlasmaDetek 2



▲ MultiDetek2

▲ PlasmaDetek2

SF6 is used in the electrical industry as a gaseous dielectric medium for high-voltage circuit breakers, switchgear and other electrical equipment. Due to its high electrical insulation properties, it is often used for replacing oil filled circuit breakers. The sulfur hexafluoride is an expensive gas and it also has been identified as the most potent greenhouse gas. A SF6 purity monitoring instrument is then required in the electrical industry to prevent failures, extend equipment life, reduces equipment cost and increase safety.

LDETEK SOLUTION:

Using the compact MultiDetek2 combined with the robust PlasmaDetek2 detector, this application note shows our solution for measuring impurities in SF6 to ensure good operations of electrical equipment. The system has been configured with two channels both merging in the PlasmaDetek2 detector.

The first channel is used for measuring O2-N2-CO using a porous polymer Q type pre column combined with a Mol Sieve separation column. The pre column is mounted on a 10 port injection/back flush diaphragm valve to flush out the SF6. The second column allows the separation of O2-N2 and CO.

The second channel is used for CF4 analysis. This channel is also mounted with a 10 port injection/back flush diaphragm valve with two Porapak Q type columns. The pre column is used to flush out the SF6 and the second column for separation of CF4 from other impurities. This channel can also allow the analysis of CO2 and SOF2.

RESULTS:

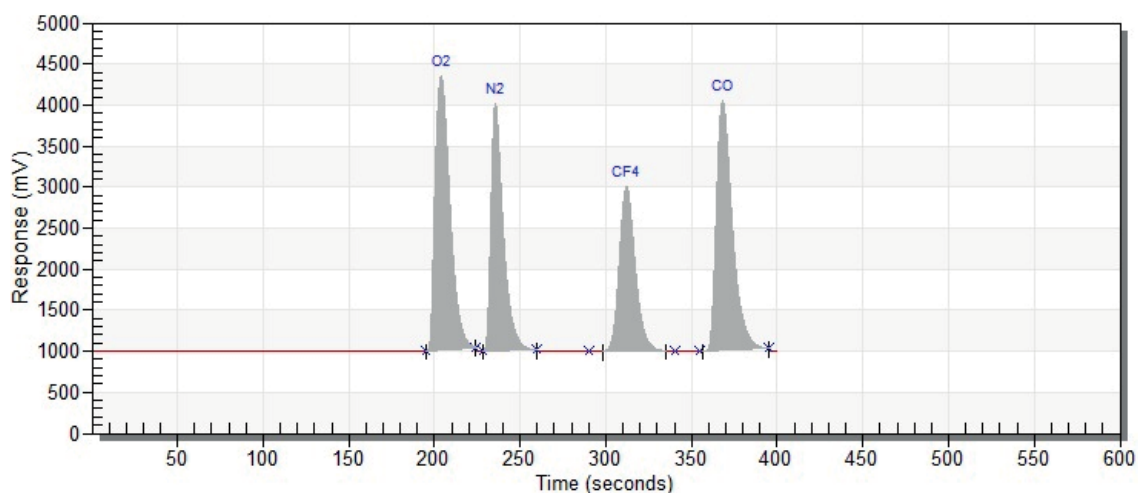

Figure 1: Chromatogram of trace impurities in balance SF6

COMPONENT	CONCENTRATION	PEAK HEIGHT	NOISE	LDL (3X NOISE)
O ₂	1701 ppm	4425 mV	2 mV	2.3 ppm
N ₂	1446 ppm	4101 mV	0.2 mV	0.6 ppm
CF ₄	64 ppm	3055 mV	10 mV	0.6 ppm
CO	196 ppm	4170 mV	5 mV	0.7 ppm

Note: other LDL could be obtained with different injection volume and chromatographic conditions

Figure 2: LDL based on 3 times noise ratio

CONCLUSION:

Using a solution combining the PlasmaDetek 2 and the MultiDetek 2 is the best way to achieve sensitivity, robustness and speed in a compact GC system for sulfur hexafluoride purity analysis for the energy market.

APPLICATION NOTE

LD22-02



Measurement of trace impurities in UHP hydrogen for fuel cells with the HyDetek system solution



▲ MultiDetek3 Ex

▲ HyDetek system

3.0 APPLICATION NOTES

SHIFT POWER TO ZERO EMISSION

Hydrogen fuel cells offer reliability and a smaller carbon footprint compared to diesel and battery systems.

An hydrogen fuel cell is an electrochemical cell that converts the chemical energy of a fuel (hydrogen) and an oxidizing agent (often oxygen) into electricity through a pair of redox reactions.

Fuel cells come in many varieties; however, they all work in the same general manner. They are made up of three adjacent segments: the anode the electrolyte, and the cathode. Two chemical reactions occur at the interfaces of the three different segments. The net result of the two reactions is that fuel is consumed, water is created, and an electric current is created, which can be used to power electrical devices, normally referred to as the load.

To keep the durability and the performances of the fuel cells, the hydrogen used must conform to the ISO 14687 Part 2 to know and measure the acceptable limits of contaminants as listed in the table.

Constituent	Chemical Formula	Limits	Laboratory Test Methods to Consider and Under Development*	Minimum Analytical Detection Limit
Hydrogen fuel index	H ₂	> 99.97%		
Total allowable non-hydrogen, non-helium, non-particulate constituents listed below		100		
Acceptable limit of each individual constituent				
Water ^a	H ₂ O	5	ASTM D7653-10, ASTM D7649-10	0.12
Total hydrocarbons ^b (C ₁ basis)		2	ASTM D7675-11	0.1
Oxygen	O ₂	5	ASTM D7649-10	1
Helium		300	ASTM D1945-03	100
Nitrogen, Argon	N ₂ , Ar	100	ASTM D7649-10	5
Carbon dioxide	CO ₂	2	ASTM D7649-10, ASTM D7653-10	0.1
Carbon monoxide	CO	0.2	ASTM D7653-10	0.01
Total sulfur ^c		0.004	ASTM D7652-11	0.00002
Formaldehyde	HCHO	0.01	ASTM D7653-10	0.01
Formic acid	HCOOH	0.2	ASTM D7550-09, ASTM D7653-10	0.02
Ammonia	NH ₃	0.1	ASTM D7653-10	0.02
Total halogenates ^d		0.05	(Work Item 23815)	0.01
Particulate Concentration		1 mg/kg	ASTM D7650-10, ASTM D7651-10	0.005 mg/kg

The purpose of this hydrogen fuel quality standard is to specify hydrogen fuel quality requirements for all commercial hydrogen fueling stations for proton exchange membrane (PEM) fuel cell vehicles (FCVs).

APPLICATIONS

Power

Stationary fuel cells are used for commercial, industrial and residential primary and backup power generation. Fuel cells are very useful as power sources in remote locations, such as spacecraft, remote weather stations, large parks, communications centers, rural locations including research stations, and in certain military applications. A fuel cell system running on hydrogen can be compact and lightweight and have no major moving parts.

Transports

A hydrogen vehicle is a vehicle that uses hydrogen fuel for motive power. Hydrogen vehicles include automobiles, buses, forklifts, trains, boats, airplanes, submarines, rockets and others. The power plants of such vehicles convert the chemical energy of hydrogen to mechanical energy either by burning hydrogen in an internal combustion engine or, more commonly, by reacting hydrogen with oxygen in a fuel cell to run electric motors which generate water as green contaminant.

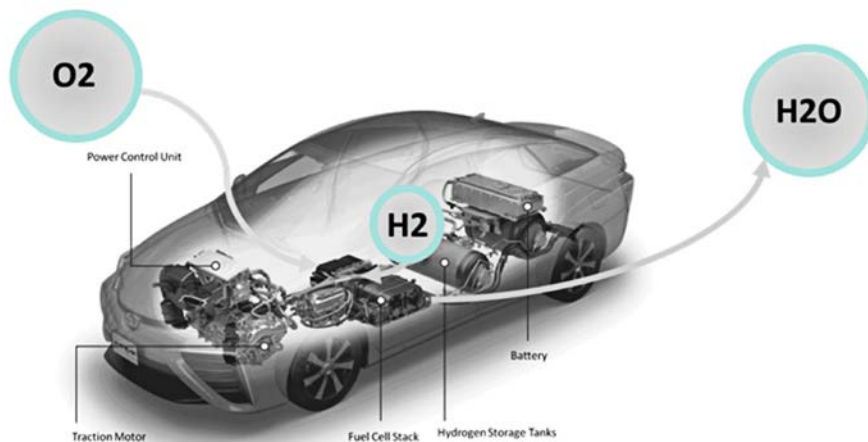

HYDROGEN PRODUCTION

Although abundant on earth as an element, hydrogen is almost always found as part of another compound, such as water (H₂O) or methane (CH₄) and must be separated into pure hydrogen (H₂) for use in fuel cell electric vehicles.

Hydrogen can be produced from diverse, domestic resources including fossil fuels, biomass, and water electrolysis with electricity. The environmental impact and energy efficiency of hydrogen depends on how it is produced.

Although today most hydrogen is produced from natural gas, the Fuel Cell Technologies Office is exploring a variety of ways to produce hydrogen from renewable resources. We will explain here the most common techniques used to produce hydrogen for fuel cell which are NG reforming and water electrolysis.

PRODUCTION BY NATURAL GAS REFORMING

Natural gas reforming is an advanced and mature production process that builds upon the existing natural gas pipeline delivery infrastructure. Today, most of the hydrogen produced in the world is made by natural gas reforming in large central plants. This is an important technology pathway for near-term hydrogen production.

How does it work?

Natural gas contains methane (CH₄) that can be used to produce hydrogen with thermal processes, such as steam-methane reformation and partial oxidation.

Steam-methane reforming

Most hydrogen produced today is made via steam-methane reforming, a mature production process in which high-temperature steam (700°C–1,000°C) is used to produce hydrogen from a methane source, such as natural gas. In steam-methane reforming, methane reacts with steam under 3–25 bar pressure (1 bar = 14.5 psi) in the presence of a catalyst to produce hydrogen, carbon monoxide, and a relatively small amount of carbon dioxide. Steam reforming is endothermic—that is, heat must be supplied to the process for the reaction to proceed. Subsequently, in what is called the «water-gas shift reaction,» the carbon monoxide and steam are reacted using a catalyst to produce carbon dioxide and more hydrogen. In a final process step called «pressure-swing adsorption,» carbon dioxide and other impurities are removed from the gas stream, leaving essentially pure hydrogen. Steam reforming can also be used to produce hydrogen from other fuels, such as ethanol, propane, or even gasoline.

Steam-methane reforming reaction
 $\text{CH}_4 + \text{H}_2\text{O} (+ \text{heat}) \rightarrow \text{CO} + 3\text{H}_2$

Water-gas shift reaction
 $\text{CO} + \text{H}_2\text{O} \rightarrow \text{CO}_2 + \text{H}_2 (+ \text{small amount of heat})$

Partial oxidation

In partial oxidation, the methane and other hydrocarbons in natural gas react with a limited amount of oxygen (typically from air) that is not enough to completely oxidize the hydrocarbons to carbon dioxide and water. With less than the stoichiometric amount of oxygen available, the reaction products contain primarily hydrogen and carbon monoxide (and nitrogen, if the reaction is carried out with air rather than pure oxygen), and a relatively small amount of carbon dioxide and other compounds. Subsequently, in a water-gas shift reaction, the carbon monoxide reacts with water to form carbon dioxide and more hydrogen.

Partial oxidation is an exothermic process—it gives off heat. The process is, typically, much faster than steam reforming and



requires a smaller reactor vessel. As can be seen in chemical reactions of partial oxidation, this process initially produces less hydrogen per unit of the input fuel than is obtained by steam reforming of the same fuel.

Partial oxidation of methane reaction
 $\text{CH}_4 + \frac{1}{2}\text{O}_2 \rightarrow \text{CO} + 2\text{H}_2 (+ \text{heat})$

Water-gas shift reaction
 $\text{CO} + \text{H}_2\text{O} \rightarrow \text{CO}_2 + \text{H}_2 (+ \text{small amount of heat})$

Why Is This Pathway Being Considered?

Reforming low-cost natural gas can provide hydrogen today for fuel cell electric vehicles (FCEVs) as well as other applications. Over the long term, DOE expects that hydrogen production from natural gas will be augmented with production from renewable, nuclear, coal (with carbon capture and storage), and other low-carbon, domestic energy resources.

Petroleum use and emissions are lower than for gasoline-powered internal combustion engine vehicles. The only product from an FCEV tailpipe is water vapor but even with the upstream process of producing hydrogen from natural gas as well as delivering and storing it for use in FCEVs, the total greenhouse gas emissions are cut in half and petroleum is reduced over 90% compared to today's gasoline vehicles.

PRODUCTION BY WATER ELECTROLYSIS

Electrolysis is a promising option for hydrogen production from renewable resources. Electrolysis is the process of using electricity to split water into hydrogen and oxygen. This reaction takes place in a unit called an electrolyser. Electrolysers can range in size from small, appliance-size equipment that is well-suited for small-scale distributed hydrogen production to large-scale, central production facilities that could be tied directly to renewable or other non-greenhouse-gas-emitting forms of electricity production. The hydrogen produced is used by the industries, transports and for the production of ammonia and methanol.

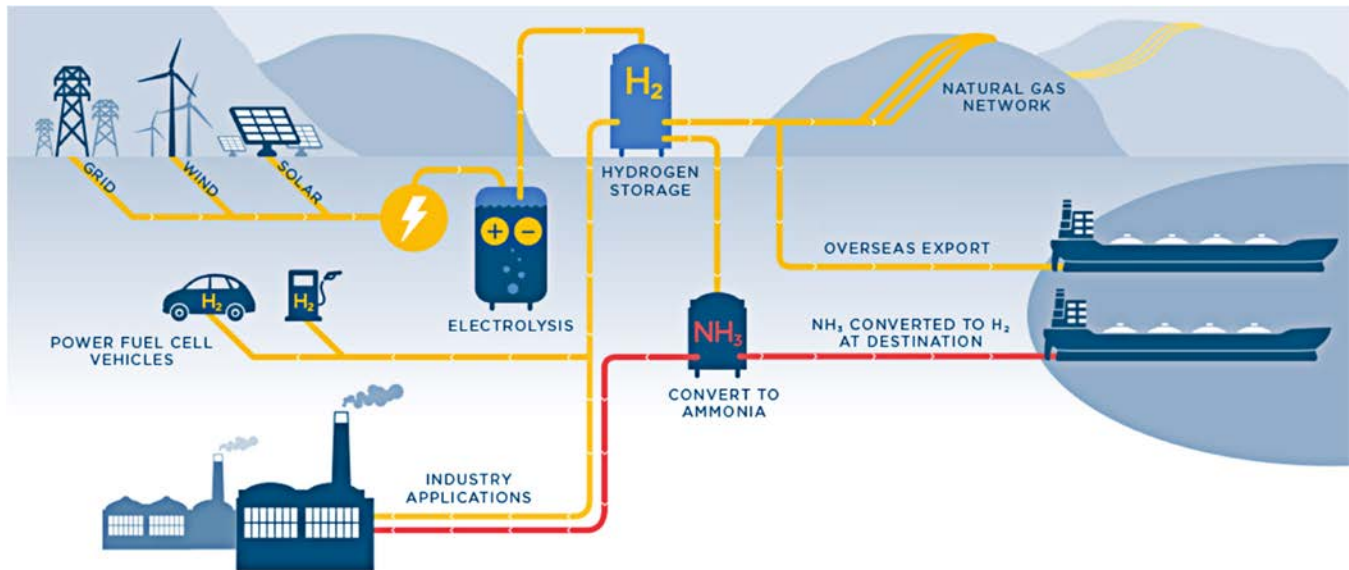

How does it work?

Like fuel cells, electrolyzers consist of an anode and a cathode separated by an electrolyte. Different electrolyzers function in slightly different ways, mainly due to the different type of electrolyte material involved.

Polymer electrolyte membrane electrolyzers

In a polymer electrolyte membrane (PEM) electrolyzer, the electrolyte is a solid specialty plastic material.

- ▶ Water reacts at the anode to form oxygen and positively charged hydrogen ions (protons).
- ▶ The electrons flow through an external circuit and the hydrogen ions selectively move across the PEM to the cathode.
- ▶ At the cathode, hydrogen ions combine with electrons from the external circuit to form hydrogen gas.
Anode Reaction: $2\text{H}_2\text{O} \rightarrow \text{O}_2 + 4\text{H}^+ + 4\text{e}^-$ Cathode Reaction: $4\text{H}^+ + 4\text{e}^- \rightarrow 2\text{H}_2$

Alkaline electrolyzers

Alkaline electrolyzers operate via transport of hydroxide ions (OH^-) through the electrolyte from the cathode to the anode with hydrogen being generated on the cathode side. Electrolysers using a liquid alkaline solution of sodium or potassium hydroxide as the electrolyte have been commercially available for many years. Newer approaches using solid alkaline exchange membranes as the electrolyte are showing promise on the lab scale.

Solid oxide electrolyzers

Solid oxide electrolyzers, which use a solid ceramic material as the electrolyte that selectively conducts negatively charged oxygen ions (O^{2-}) at elevated temperatures, generate hydrogen in a slightly different way.

- ▶ Water at the cathode combines with electrons from the external circuit to form hydrogen gas and negatively charged oxygen ions.
- ▶ The oxygen ions pass through the solid ceramic membrane and react at the anode to form oxygen gas and generate electrons for the external circuit.

Solid oxide electrolyzers must operate at temperatures high enough for the solid oxide membranes to function properly (about 700°C – 800°C , compared to PEM electrolyzers, which operate at 70°C – 90°C , and commercial alkaline electrolyzers, which operate at 100°C – 150°C). The solid oxide electrolyzers can effectively use heat available at these elevated temperatures (from various sources, including nuclear energy) to decrease the amount of electrical energy needed to produce hydrogen from water.

Why Is This Pathway Being Considered?

Hydrogen produced via electrolysis can result in zero greenhouse gas emissions, depending on the source of the electricity used. The source of the required electricity—including its cost and efficiency, as well as emissions resulting from electricity generation—must be considered when evaluating the benefits and economic viability of hydrogen production via electrolysis. In many regions of the country, today’s power grid is not ideal for providing the electricity required for electrolysis because of the greenhouse gases released and the amount of fuel required due to the low efficiency of the electricity generation process. Hydrogen production via electrolysis is being pursued for renewable (wind) and nuclear energy options. These pathways result in virtually zero greenhouse gas and criteria pollutant emissions.

Potential for synergy with renewable energy power generation

Hydrogen production via electrolysis may offer opportunities for synergy with variable power generation, which is characteristic of some renewable energy technologies. For example, though the cost of wind power has continued to drop, the inherent variability of wind is an impediment to the effective use of wind power. Hydrogen fuel and electric power generation could be integrated at a wind farm, allowing flexibility to shift production to best match resource availability with system operational needs and market factors. Also, in times of excess electricity production from wind farms, instead of curtailing the electricity as is commonly done, it is possible to use this excess electricity to produce hydrogen through electrolysis.

ANALYSIS SOLUTION FOR NATURAL GAS REFORMING PRODUCTION

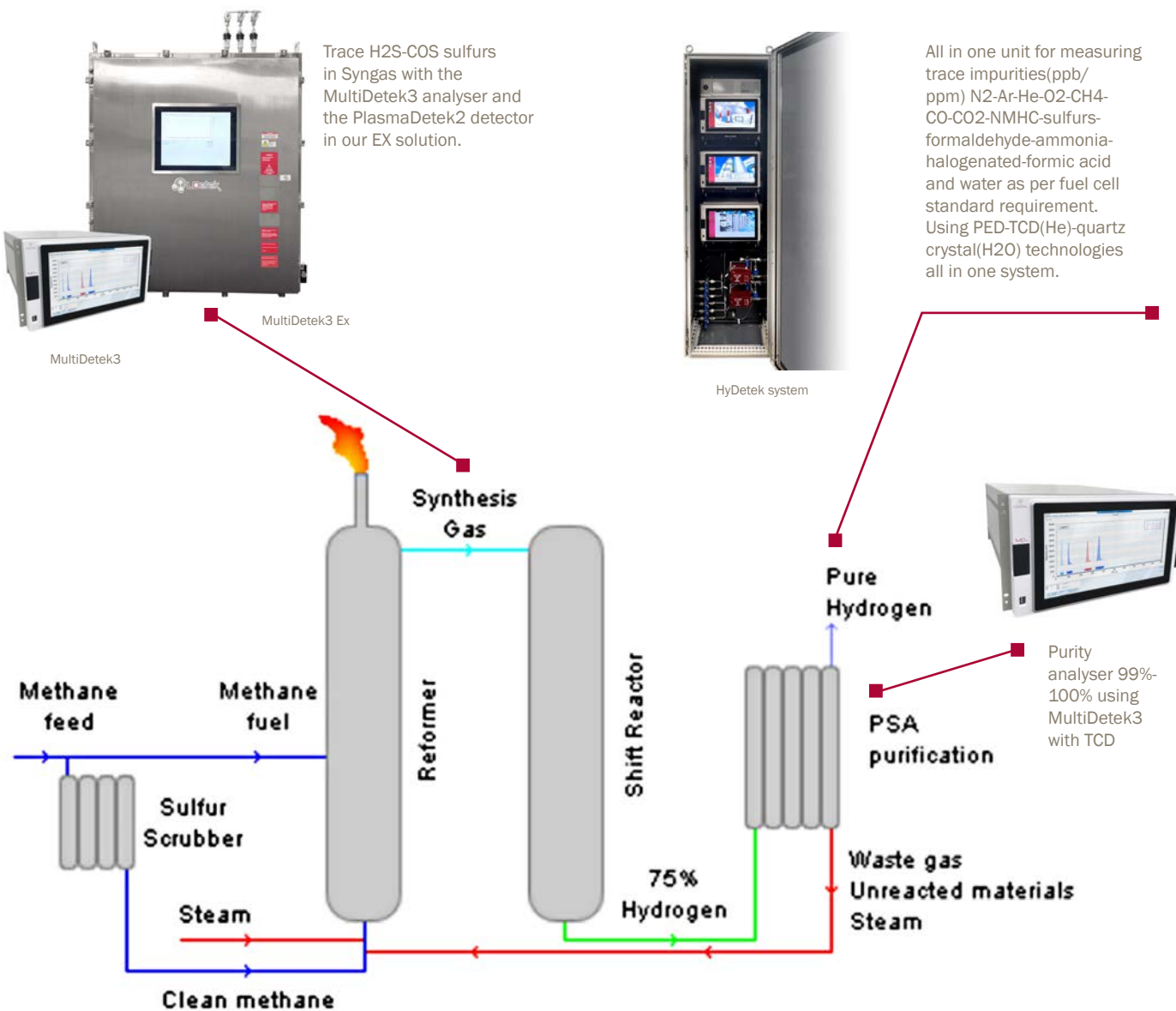

3.0 APPLICATION NOTES

About one-quarter of the incoming natural gas is burned to provide the necessary energy for the reaction, while the rest is stripped of its sulfur content. High pressure steam is added, which reacts with the methane over a nickel-alumina catalyst. The synthesis gas contains a mixture of H₂, CO₂, CO as well as unreacted CH₄ and H₂O. This gas is passed into the cooler shift reactor. The output of the shift reactor is about three quarters hydrogen. In the pressure surge adsorption unit, the impurities are removed, and recycled back through the burner, giving more than 99.9% pure hydrogen.

Synthesis gas (Syngas) measuring point

LDetek gas process analyser (GC) is used for measuring trace H₂S-COS in syngas to monitor the quality of synthesis gas used to produce carbon neutral synthetic fuels for transports and industries. The syngas produced is also used in the production of ammonia and methanol. The unit used is the MultiDetek3 GC with one PlasmaDetek2 detector configured with the right optical configuration to selectively measure low ppm/ppb H₂S and COS in a gas mixture of H₂, CO₂ and CO. The GC is configured with a MXT capillary column coated with sulfinert to avoid surface absorption for sticky impurities as sulfurs. The whole analyser flow path is coated with sulfinert to ensure the performance of the unit for measuring low ppm/ppb sulfurs. The unit can be configured for safe area with our standard compact rackmount instrument or for an Ex-Proof area with our purged/pressurized enclosure.

Pressure swing adsorption (PSA) hydrogen measuring point

The MultiDetek3 is also installed for measuring the purity of H₂ in percent right after the PSA stage. The unit is configured for measuring 99%-100% hydrogen purity with a TCD. The unit can be configured for safe area with our standard compact rackmount instrument or for an Ex-Proof area with our purged/pressurized enclosure.

Pure hydrogen measuring point

Most importantly the MultiDetek3 is used to measure the final high purity hydrogen produced. The instrument is configured with a combination of detectors like PED for sub ppb impurities measurement and our TCD for ppm He analysis and the quartz crystal module for trace moisture. With all the modules being mounted in the same analysis solution, LDetek can provide the complete spectrum of analysis required for the fuel cell hydrogen as per SAE standards. The unit can be configured for safe area with our standard compact rackmount instrument or for an Ex-Proof area with our purged/pressurized enclosure. As described in the results section, two instruments model MultiDetek3 GCs are required to cover the complete application. One GC for the analysis of ppb sulfurs, formic acid, formaldehyde, ammonia and halogenated. Another GC for measuring the trace O₂-Ar-N₂-CH₄-CO-CO₂-NMHC-He-H₂O.

ANALYSIS SOLUTION FOR WATER ELECTROLYSIS PRODUCTION



HyDetek system

All in one unit for measuring trace impurities(ppb/ppm) N₂-Ar-He-O₂-CH₄-CO-CO₂-NMHC-sulfurs-formaldehyde-ammonia-halogenated-formic acid and water as per fuel cell standard requirement. Using PED-TCD(He)-quartz crystal(H₂O) technologies all in one system.



MultiDetek3 Ex

All in one unit for measuring trace impurities(ppb/ppm) N₂-Ar-O₂-CO-CO₂ and water as per fuel cell standard requirement. Using PED & quartz crystal(H₂O) technologies all in one system.



MultiDetek3

or

or

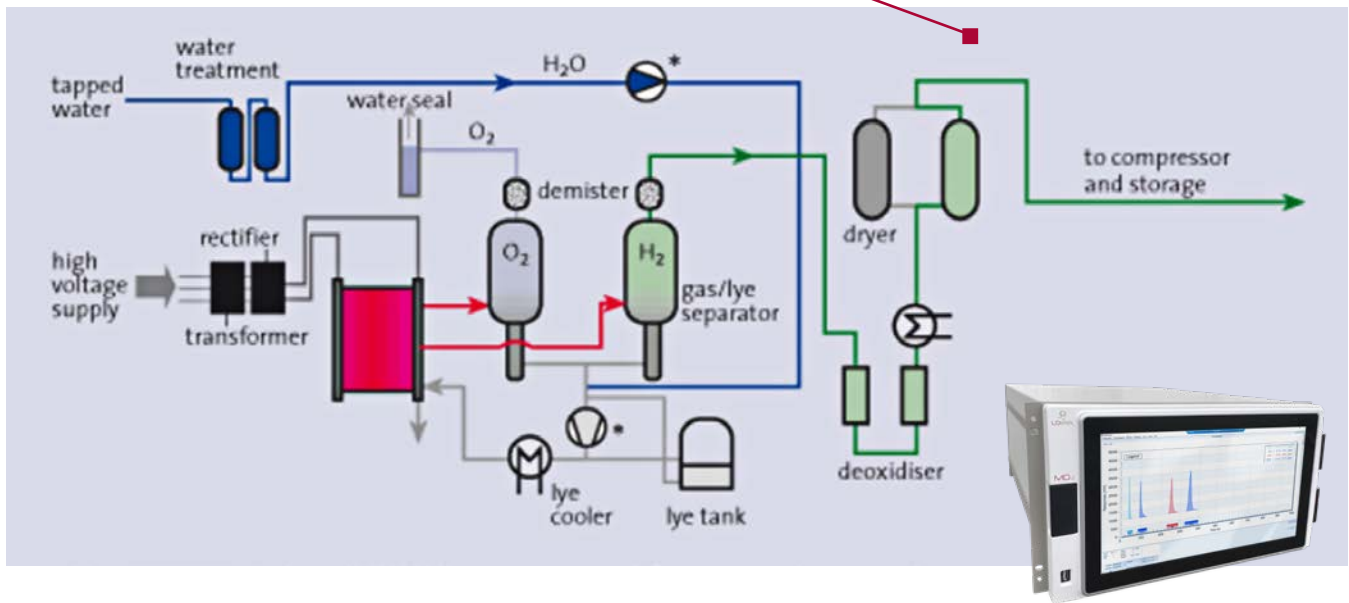

Purity analyser 99%-100% using MultiDetek3 with TCD

Pure hydrogen measuring point

For the hydrogen production by water electrolysis the MultiDetek3 is used for measuring the purity of hydrogen with its percent solution mode using our TCD detector with a range of 99%-100%. For the trace impurities in sub ppb, the unit is configured with its PED for all impurities required by SAE standards and its quartz crystal module for trace moisture. By this production method, it generally becomes not necessary to measure sulfurs, halogenated, formaldehyde, hydrocarbons and formic acid since the production process doesn't produce/contains these contaminants. It makes an analysis solution being simpler and focus on the analysis of the trace O₂-Ar-N₂-CO-CO₂-H₂O. Other configuration variances of the MultiDetek3 with more or less impurities to measure can be modified with the modularity of the MultiDetek3 platform.

MEASURING POINTS FOR HYDROGEN PRODUCTION

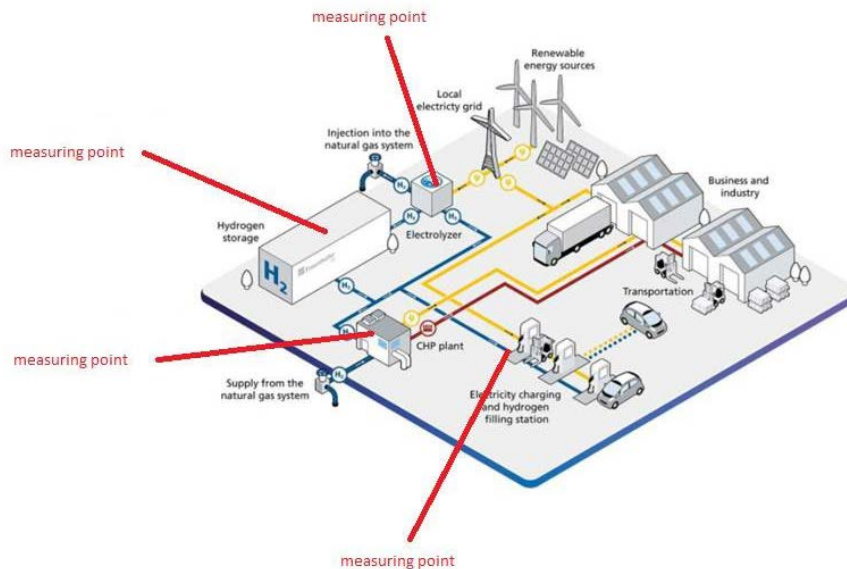

HOW ARE THE MULTIDETEK3 INSTRUMENTS CONFIGURED

Using its PlasmaDetek2 detector (patented) combined with a TCD (He) and the quartz crystal (H₂O), LDetek can provide a solution for the complete analysis of all the contaminants that must be measured in hydrogen fuel cell. Combined with its GC modular platform MultiDetek3, this document will demonstrate how the units are configured to achieve sub ppb detection required for this application.

The most complete configuration for the complete fuel cell hydrogen production requires up to three instruments model MultiDetek3. The modularity of the unit makes it possible to apply some variances depending of application requirements. Each GC is configured with different channels that will be described.

MULTIDETEK3 GC#1

CHANNEL 1: H₂S-COS-NH₃-CH₂O-CH₂CL₂

IMPURITIES	RANGE (PPB)	LDL (PPB)	REPEATABILITY (%)	DETECTOR
H ₂ S (hydrogen sulfide)	0-500	0.4	0.8	PED
COS (carbonyl sulfide)	0-500	0.5	0.6	PED
NH ₃ (ammonia)	0-1000	2.5	0.3	PED
CH ₂ O (formaldehyde)	0-500	2.0	0.4	PED
Halogenated as HCL	0-1000	10.0	1.0	PED

CHANNEL 2: CH₄S-CS₂-DMS-DMDS-HCOOH

IMPURITIES	RANGE (PPB)	LDL (PPB)	REPEATABILITY (%)	DETECTOR
CH ₄ S (methyl mercaptan)	0-500	0.5	1.5	PED
CS ₂ (carbon disulfide)	0-500	0.2	0.7	PED
DMS (dimethyl sulfide)	0-500	0.2	0.9	PED
DMDS (dimethyl disulfide)	0-500	0.45	1.6	PED
HCOOH (formic acid)	0-1000	2.0	0.4	PED

CHANNEL 3: *CHOICE BETWEEN HE OR H₂O

IMPURITIES	RANGE (PPM)	LDL (PPB)	REPEATABILITY (%)	DETECTOR
He	0-1000	1 (ppm)	0.5	TCD
H ₂ O	0-10	10.0	0.5	Quartz crystal

*This channel can be split or interchanged in GC#1 or GC#2 depending of the requirements

Both channels 1-2 used the PlasmaDetek2 detector configured with a selective optical filter for sulfurs and one for formaldehyde/ammonia/formic acid. Each optic has a narrow wavelength limiting the interference from hydrogen background and offering a sensitivity to sub ppb. Both channels are configured with proper sulfinert coated diaphragm valves, fittings and tubing to avoid any risk of surface absorption for the impurities to measure at ppb level. The columns used are capillaries/sulfinert/metalized MXT series offering no resistance to sticky and absorptive gases. Outstanding sensitivity can be obtained by combining the right GC components together with our sensitive/selective PlasmaDetek2 sensor.

The third channel can be configured with a TCD for measuring ppm Helium or with a quartz crystal detector for measuring trace H2O. If both are required, then the second detector can be mounted in the channel 3 of the GC#2. For the trace He with a TCD, an Argon carrier gas is required to the unit. In case of measuring trace H2O, then the quartz crystal detector module is mounted with its internal calibration device. Refer to our design report on the trace moisture module integrated in our MultiDetek3 for more details. (document link is available in the reference section).

MULTIDETEK3 GC#2

CHANNEL 1: N2-CH4-CO-CO2

IMPURITIES	RANGE (PPM)	LDL (PPB)	REPEATABILITY (%)	DETECTOR
N2	0-10	1.5	0.1	PED
CH4	0-10	3.5	0.1	PED
CO	0-10	1.5	0.1	PED
CO2	0-10	1.5	0.1	PED

CHANNEL 2: AR-O2-NMHC

IMPURITIES	RANGE (PPM)	LDL (PPB)	REPEATABILITY (%)	DETECTOR
Ar	0-10	0.5	0.2	PED
O2	0-10	10.0	0.2	PED
NMHC	0-10	4.0	0.6	PED

CHANNEL 3: *CHOICE BETWEEN HE OR H2O

IMPURITIES	RANGE (PPM)	LDL (PPB)	REPEATABILITY (%)	DETECTOR
He	0-1000	1 (ppm)	0.5	TCD
H2O	0-10	10.0	0.5	Quartz crystal

*this channel can be split or interchanged in GC#1 or GC#2 depending of the requirements

This unit can be configured differently depending of the requirements. The modularity of the MultiDetek3 brings the advantages of selecting the appropriate module for your need. Here, the system has been configured with a first channel with a PED for measuring trace N2-CH4-CO-CO2. This block is configured with a PlasmaDetek2 with a selective optical filter for N2, for CH4 and one for CO/CO2.

The second channel also used a PED for measuring Ar-O2-NMHC. Here the PlasmaDetek2 is configured with 3 selective optical filters. One is used for Ar, a second one is used for O2 and a third one is used for NMHC. The analysis of trace O2 here required a doping gas system to allow a stable and repetitive ppb detection of O2.

The third channel is configured as described in the GC#1 description.

MULTIDETEK3 GC#3

CHANNEL 1: PURITY HYDROGEN

Impurities	Range (%)	Accuracy (%)	Detector	Analysis time (sec)
H2	99-100	0.001	TCD	60

This instrument is required for monitoring the total purity of hydrogen from 99%-100% generally installed in combination with the trace impurities analysers. This purity instrument offers a quick analysis time of 1 minute to monitor quickly the purity of hydrogen produced. In case of a process alarm from this instrument, the trace impurities instruments will give the details of the problematic impurities. The use of both instruments is the best practice to ensure rapidity and accuracy for the hydrogen production. This Multidetek3 GC is configured with a TCD detector and a straight injection. All impurities come as one peak which is measured by the TCD. The reference and the carrier gases use are hydrogen.

RESULTS

Chromatograms : GC#1/Channel 1

Sample : 100ppb H2S, COS Balance H2

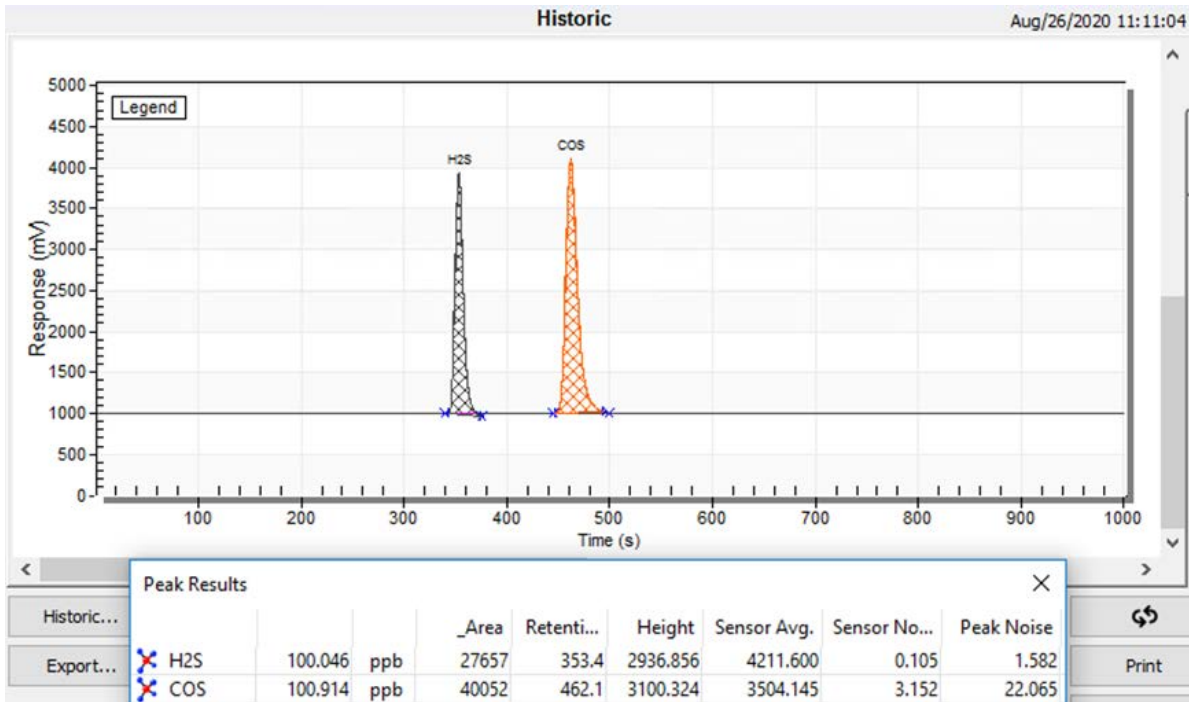

Sample : 3ppb H2S, COS Balance H2

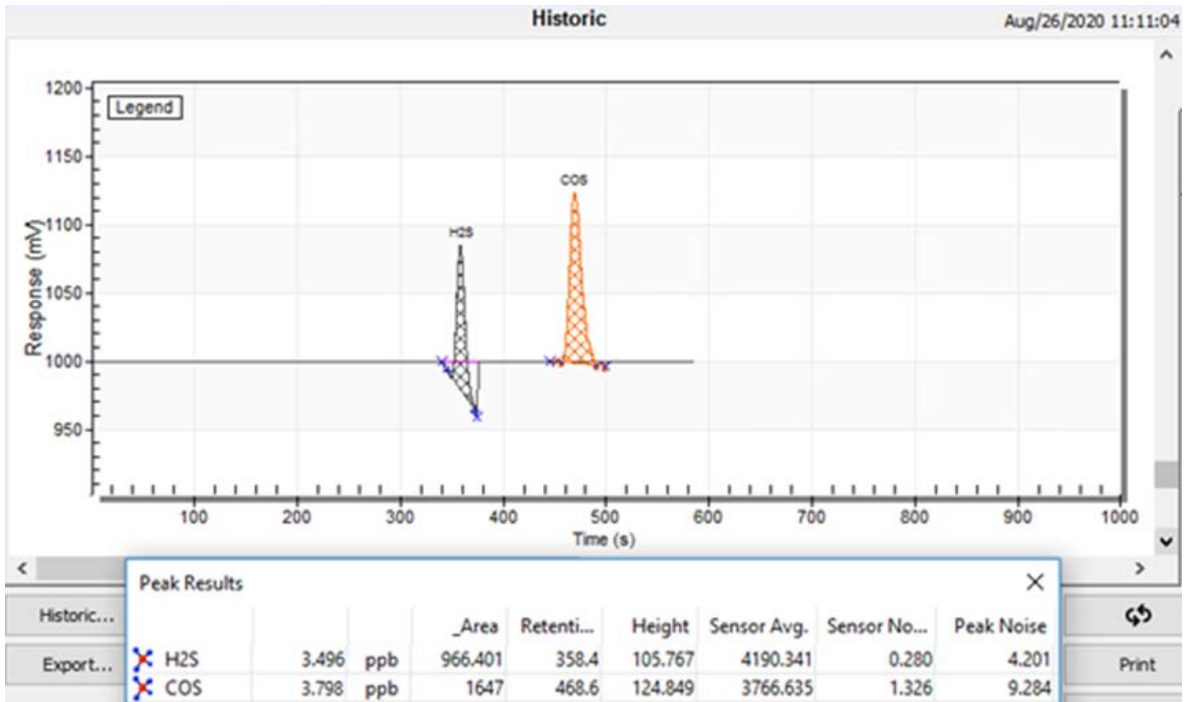

Sample: 500ppb CH2O Balance H2

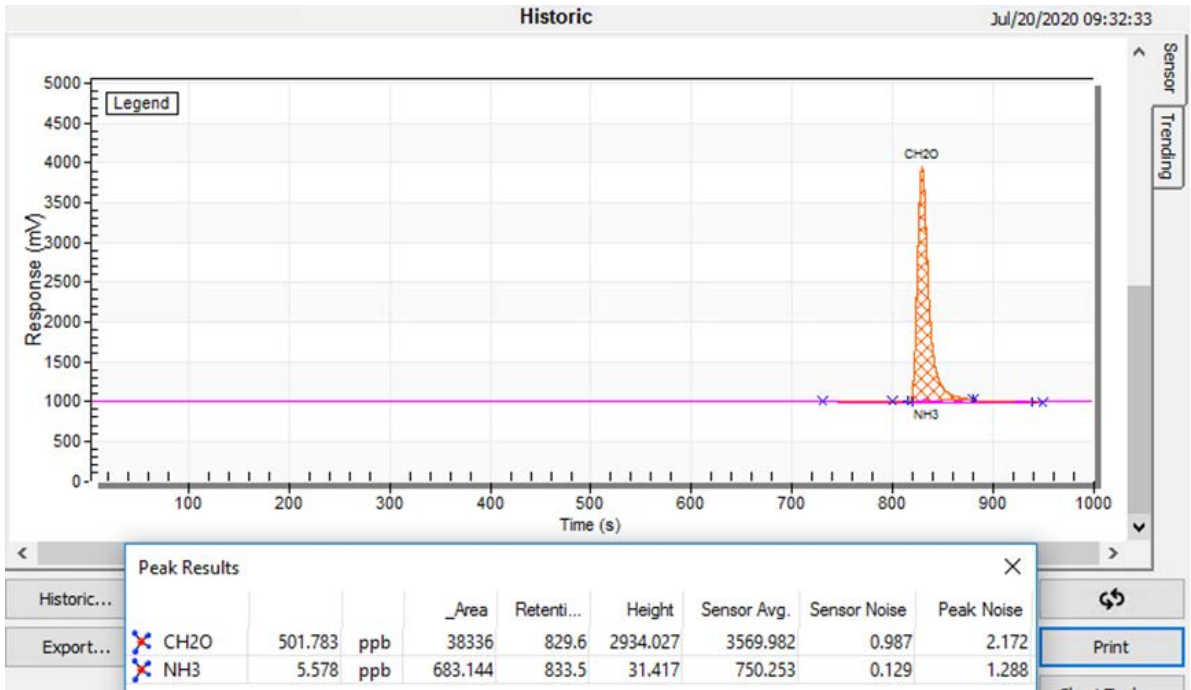

Sample: 210ppb CH2O Balance H2

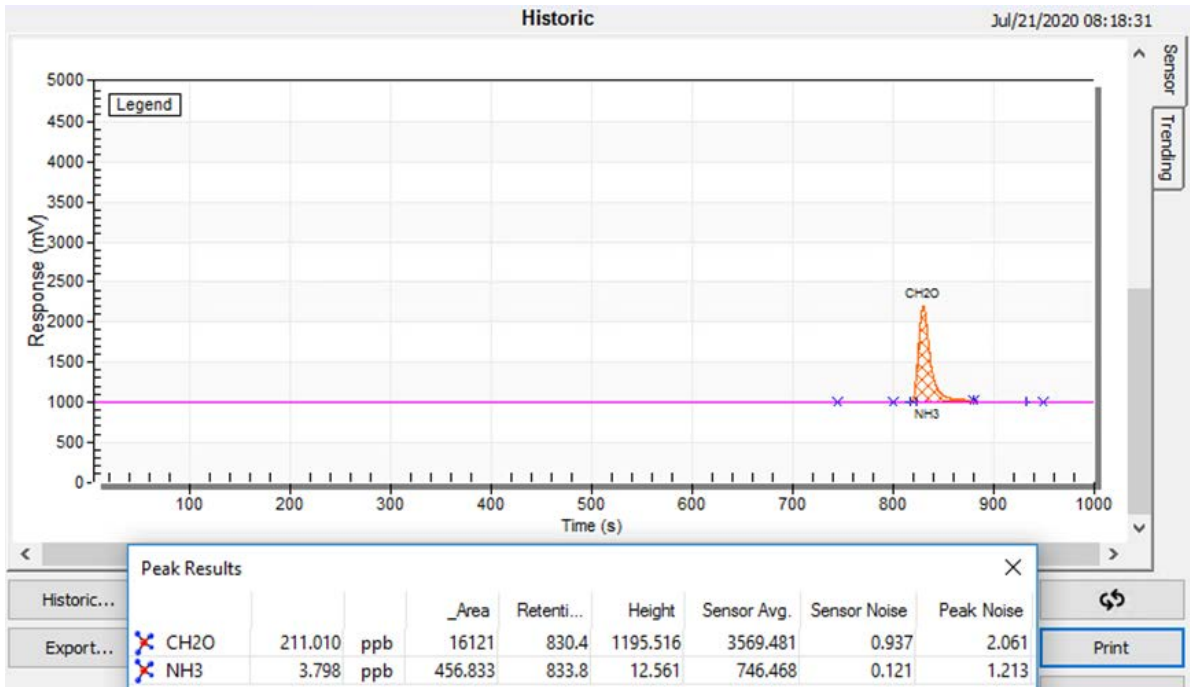

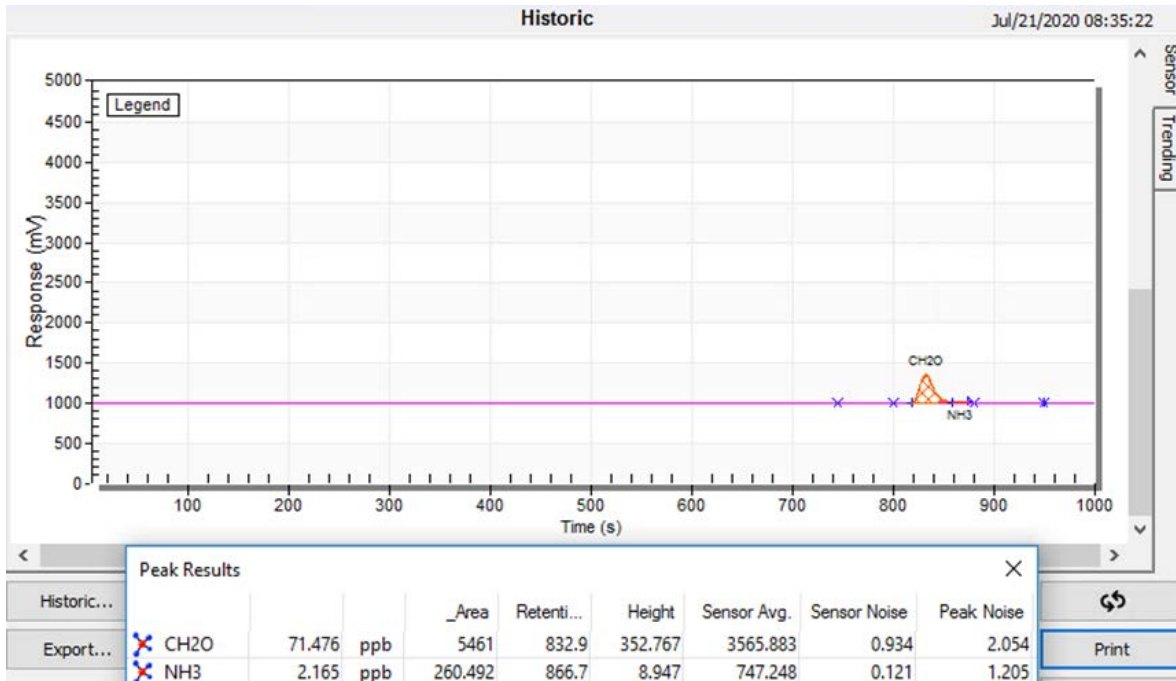
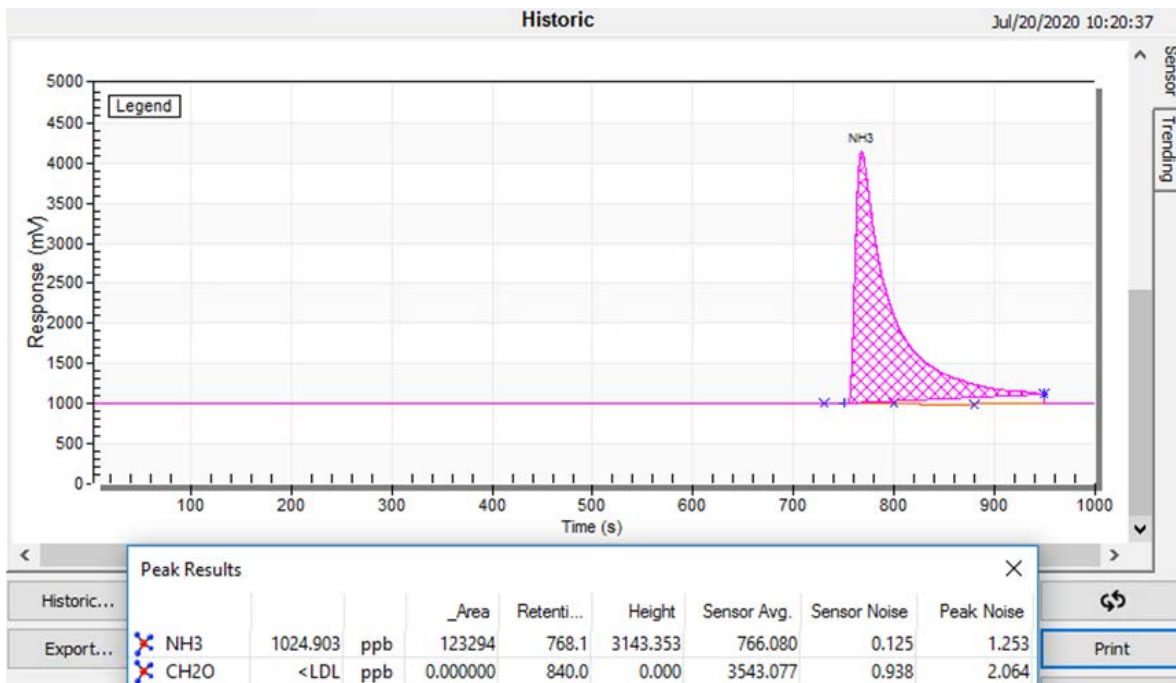
Sample: 70ppb CH₂O Balance H₂Sample: 1025ppb NH₃ Balance H₂

Sample: 510ppb NH3 Balance H2

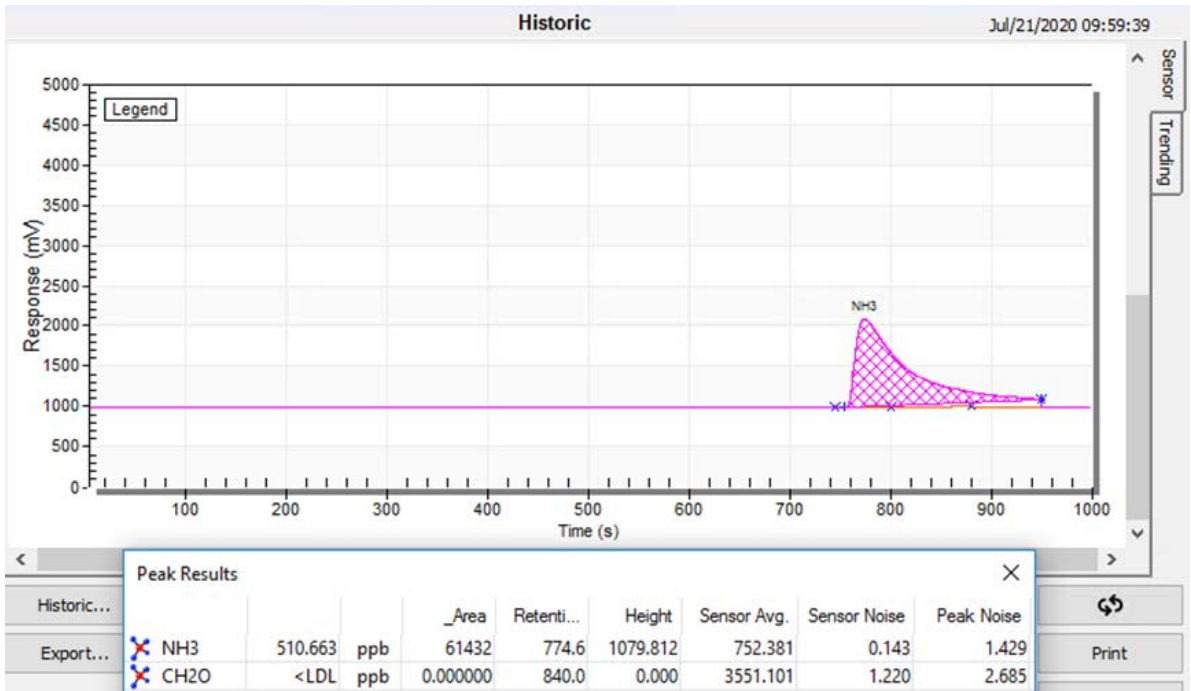

Sample: 150ppb NH3 Balance H2

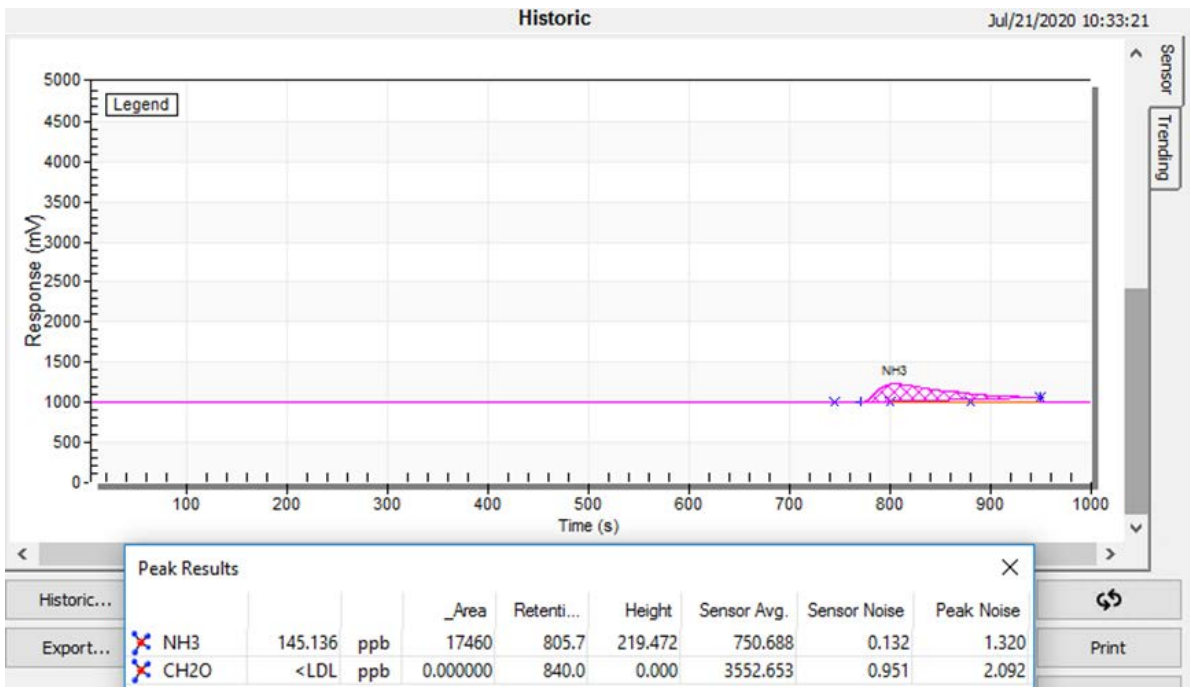

Sample: 516ppb ppb HCL (hydrogen chloride) in balance gas hydrogen

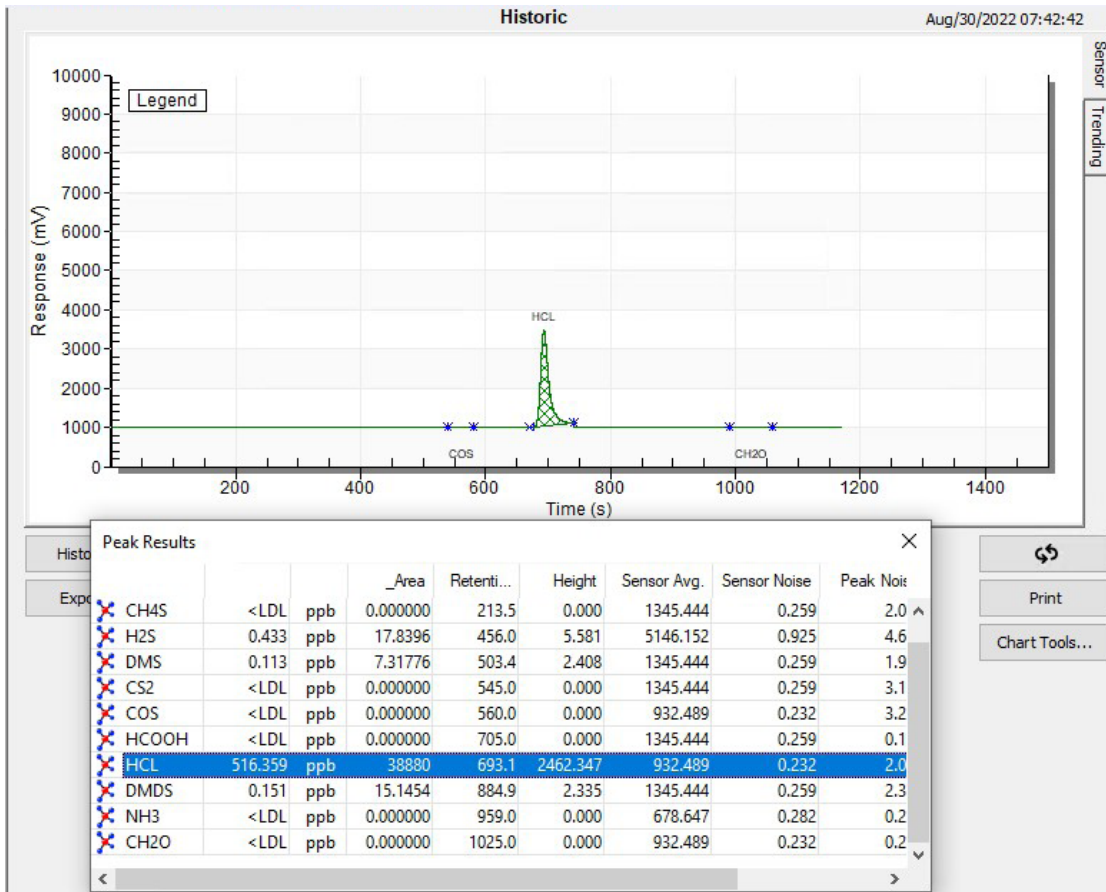

LDL :

Component	Concentration (ppb)	Peak height (mV)	Noise (mV)	LDL (3x Noise) (ppb)
H2S (hydrogen sulfide)	3.5	105.8	4.2	0.41
COS (carbonyl sulfide)	3.79	124.9	9.2	0.80
CH2O (formaldehyde)	71.4	352.7	2.05	1.24
NH3 (ammonia)	145	219.4	1.32	2.61
HCL (hydrogen chloride)	516	2462	2.0	1.25

Note: other LDL could be obtained with different injection volume and chromatographic condition

Repeatability :

Sample : 3ppb H2S, COS Balance H2

Description	H2S	COS
Wed, Aug-26-2020 17:39:32	3.564	4.102
17:29:23	3.565	4.145
17:19:13	3.533	4.151
17:09:03	3.543	4.185
16:58:53	3.506	4.121
16:48:42	3.530	4.145

Sample : 135ppb NH3 & 75ppb CH2O Balance H2

Description	NH3	CH2O
Historic Tue, Jul-21-2020 13:55:43	136.162	75.984
13:38:50	136.759	76.416
13:22:00	136.398	76.441
13:05:08	136.709	76.621
12:48:16	136.848	76.707
12:31:24	137.460	76.683

IMPURITIES	H2S	CO2	NH3	CH2O
Average (ppb)	3.534	4.142	136,7	76,48
Sigma σ (ppb)	0.028	0.028	0.44	0.27
CV (%)	0.80	0.68	0.32	0.35
CV x 3 (%)	2.40	2.05	0.97	1.06
Status	pass	pass	pass	pass
Repeatability (%)	0.8	0.6	0.3	0.4

Using a series of 6 consecutive analysis, the repeatability conformity test must be below 5% considering a value of 3 times the coefficient of variation (CV) to be accepted.

The repeatability % is obtained by applying the sigma of the 6 consecutive analysis on the average of these 6 same analysis.

The test has been performed at the bottom of the scale which is the most rigorous concentration to get a good repeatability. Running such repeatability test at higher concentration is just easier to get a better repeatability. It demonstrates the performance of the system in terms of repeatability at very low concentration.

Linearity :

Impurity : Ammonia (NH3)

Response area (counts)	Concentration (ppb)
0	0
17460	150
61432	510
123294	1025

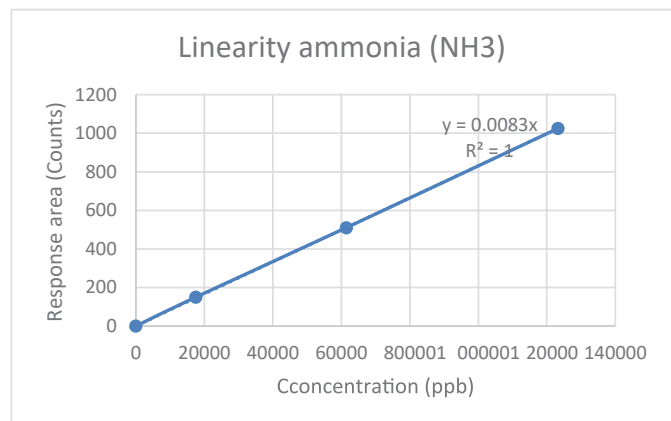

Impurity : Formaldehyde (CH2O)

Response area (counts)	Concentration (ppb)
0	0
5461	71
16121	211
38336	501

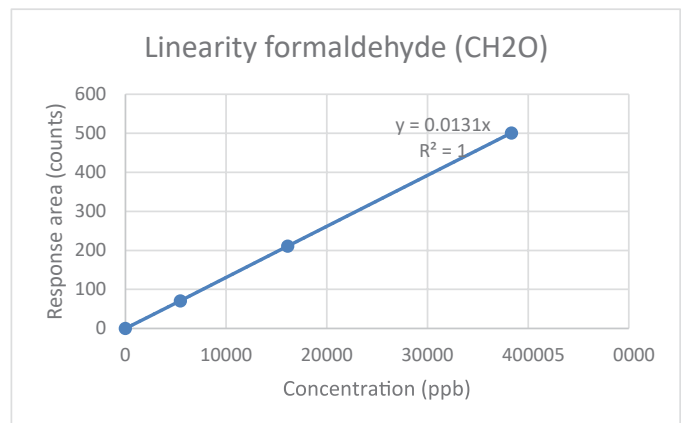

Chromatograms : GC#1/Channel 2

Sample: 100ppb CH4S-CS2-DMS-DMDS / 330ppb HCOOH Balance H2

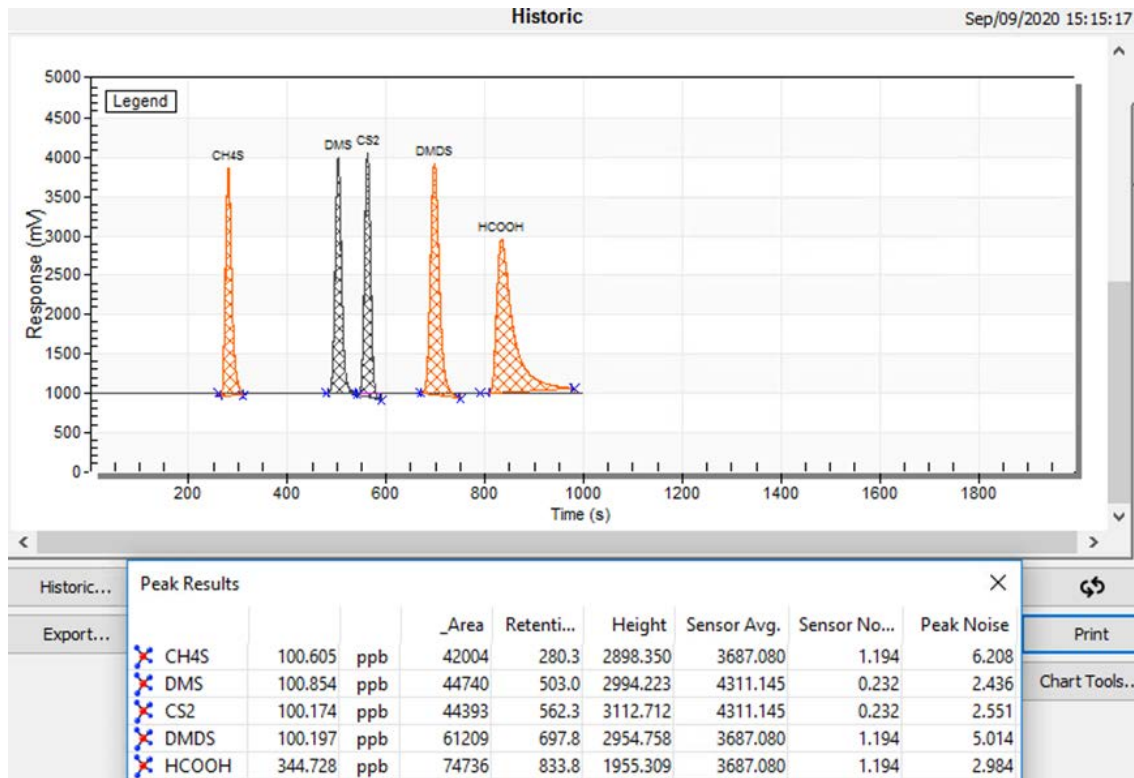

Sample : 2ppb CH4S-CS2-DMS-DMDS / 50ppb HCOOH Balance H2

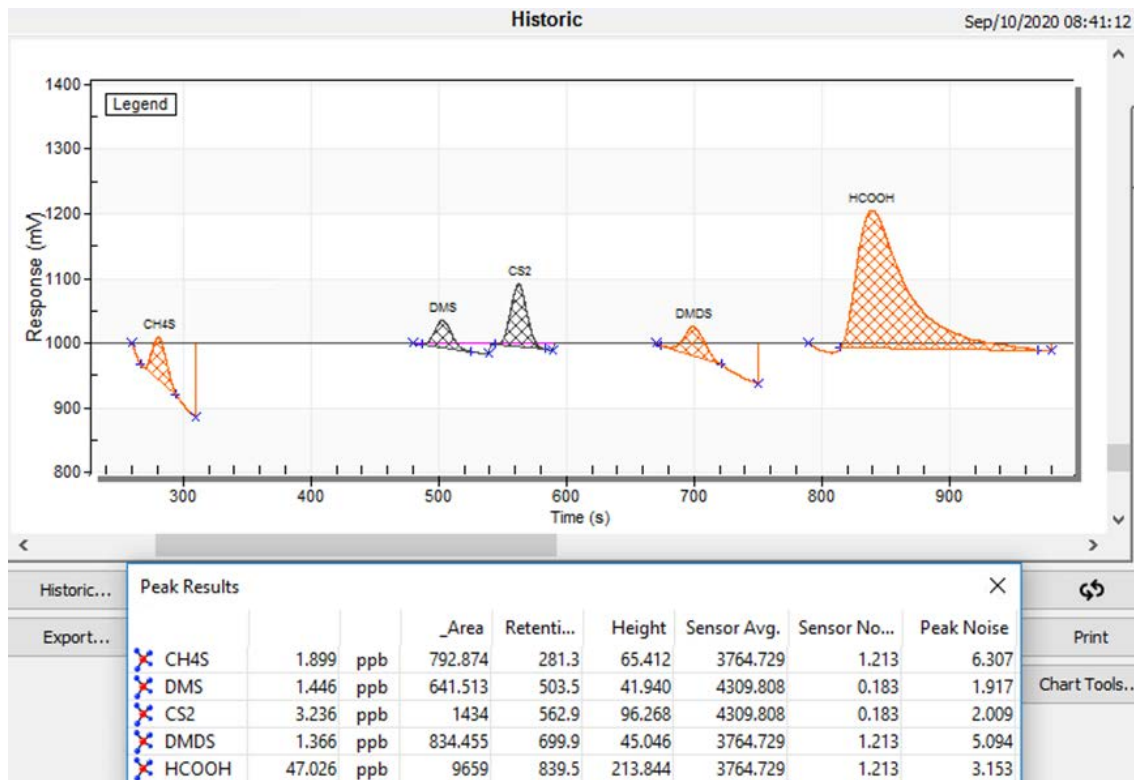

LDL :

Component	Concentration (ppb)	Peak height (mV)	Noise (mV)	LDL (3x Noise) (ppb)
CH4S (methyl mercaptan)	1.89	65.4	6.3	0.50
DMS (dimethyl sulfide)	1.44	41.9	2.0	0.20
CS2 (carbon disulfide)	3.23	96.3	1.91	0.19
DMDS (dimethyl disulfide)	1.36	45.0	5.0	0.45
HCOOH (formic acid)	47.0	213.9	3.15	2.00

Note: other LDL could be obtained with different injection volume and chromatographic condition

Stability :

Sample : 2ppb CH4S-CS2-DMS-DMDS / 50ppb HCOOH Balance H2

	Description	CH4S	DMS	CS2	DMDS	HCOOH
Historic						
☒ Thu, Sep-10-2020						
	07:49:10	1.879	1.334	3.344	1.265	47.865
	07:32:18	1.873	1.316	3.338	1.230	48.020
	07:15:26	1.904	1.343	3.359	1.226	47.958
	06:58:35	1.924	1.317	3.384	1.272	48.074
	06:41:43	1.951	1.343	3.397	1.265	48.279
	06:24:51	1.940	1.326	3.389	1.259	48.295

IMPURITIES	CH4S	DMS	CS2	DMDS	HCOOH
Average (ppb)	1.91	1.33	3.37	1.25	48,08
Sigma σ (ppb)	0.03	0.012	0.024	0.02	0.17
CV (%)	1.66	0.91	0.74	1.57	0.36
CV x 3 (%)	4.98	2.73	2.22	4.72	1.08
Status	pass	pass	pass	pass	pass
Repeatability (%)	1.5	0.9	0.7	1.6	0.4

Using a series of 6 consecutive analysis, the repeatability conformity test must be below 5% considering a value of 3 times the coefficient of variation (CV) to be accepted.

The repeatability % is obtained by applying the sigma of the 6 consecutive analysis on the average of these 6 same analysis.

The test has been performed at the bottom of the scale which is the most rigorous concentration to get a good repeatability. Running such repeatability test at higher concentration is just easier to get a better repeatability. It demonstrates the performance of the system in terms of repeatability at very low concentration.

Chromatograms : GC#2/Channel 1

Sample : 4ppm N2-CO2-CH4-CO Balance H2

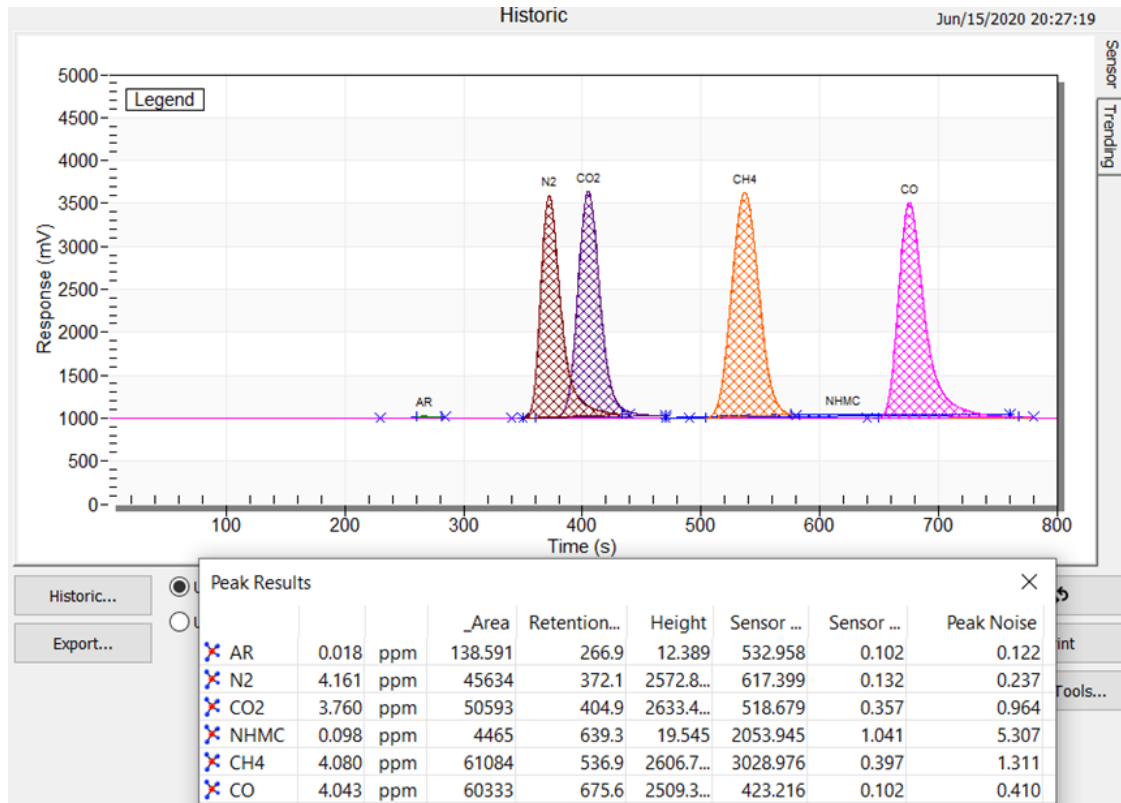

Sample : 500ppb N2-CO2-CH4-CO Balance H2

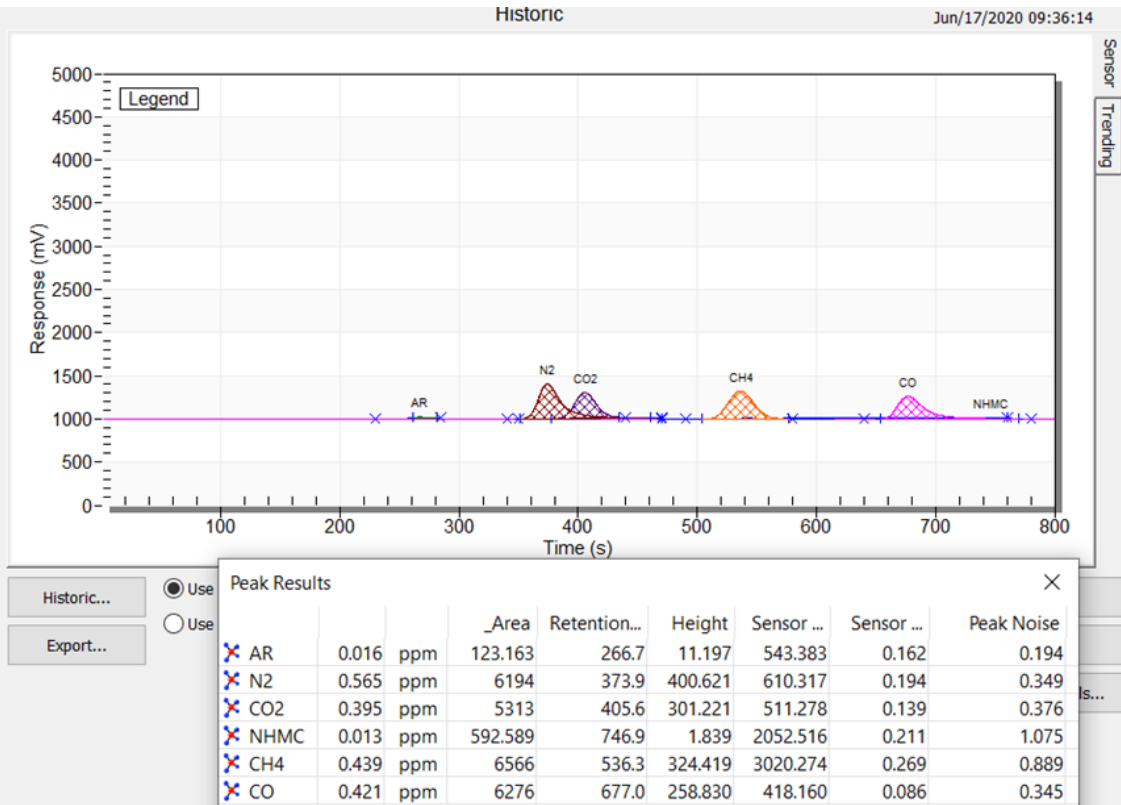

Chromatograms : GC#2/Channel 2

Sample : 4ppm Ar Balance H2

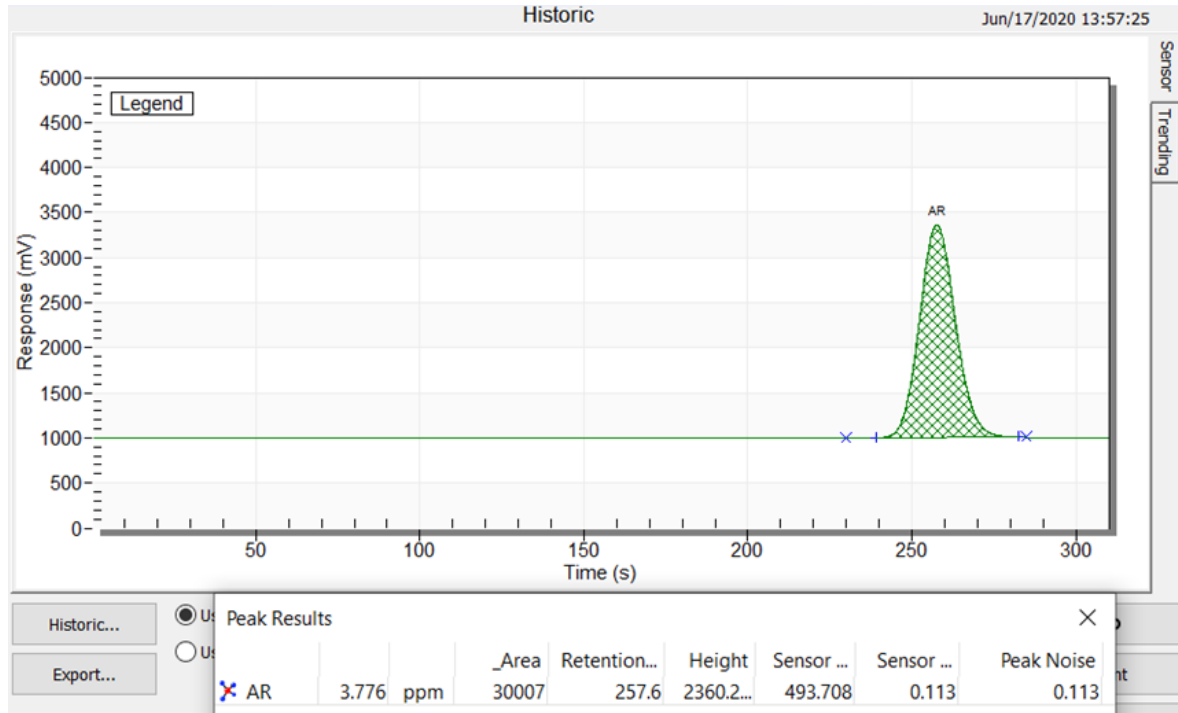

Sample : 500ppb Ar Balance H2

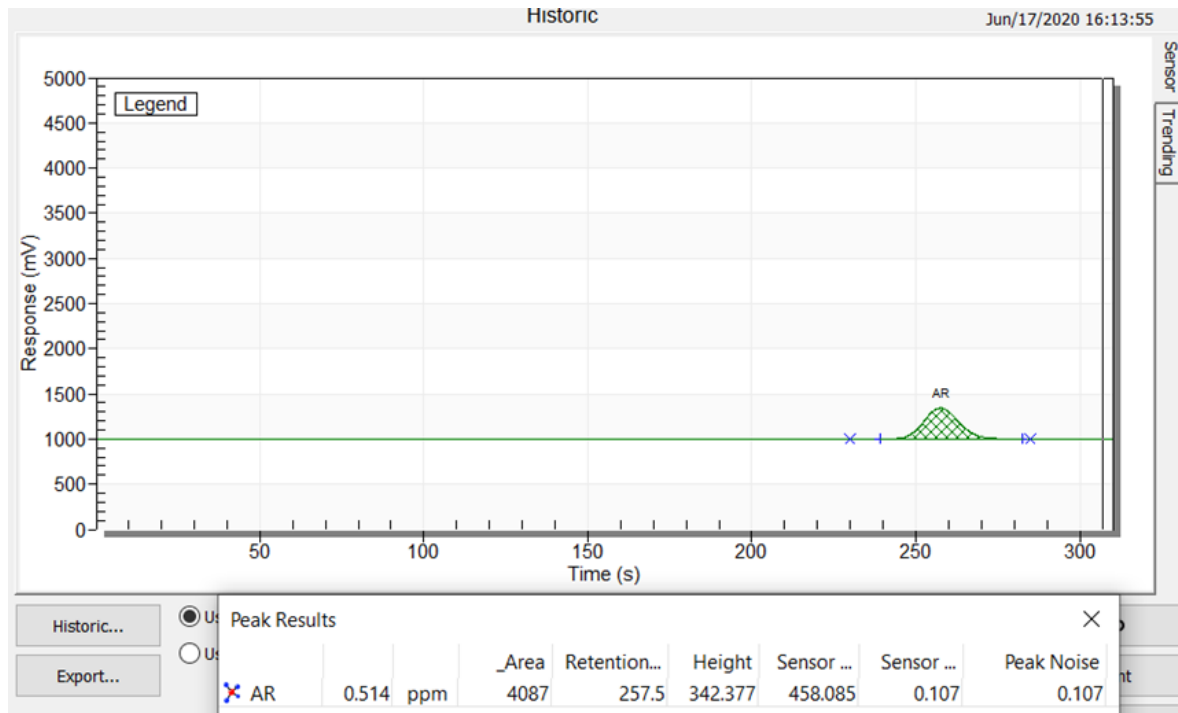

Sample : 4ppm NMHC(C3H8) Balance H2

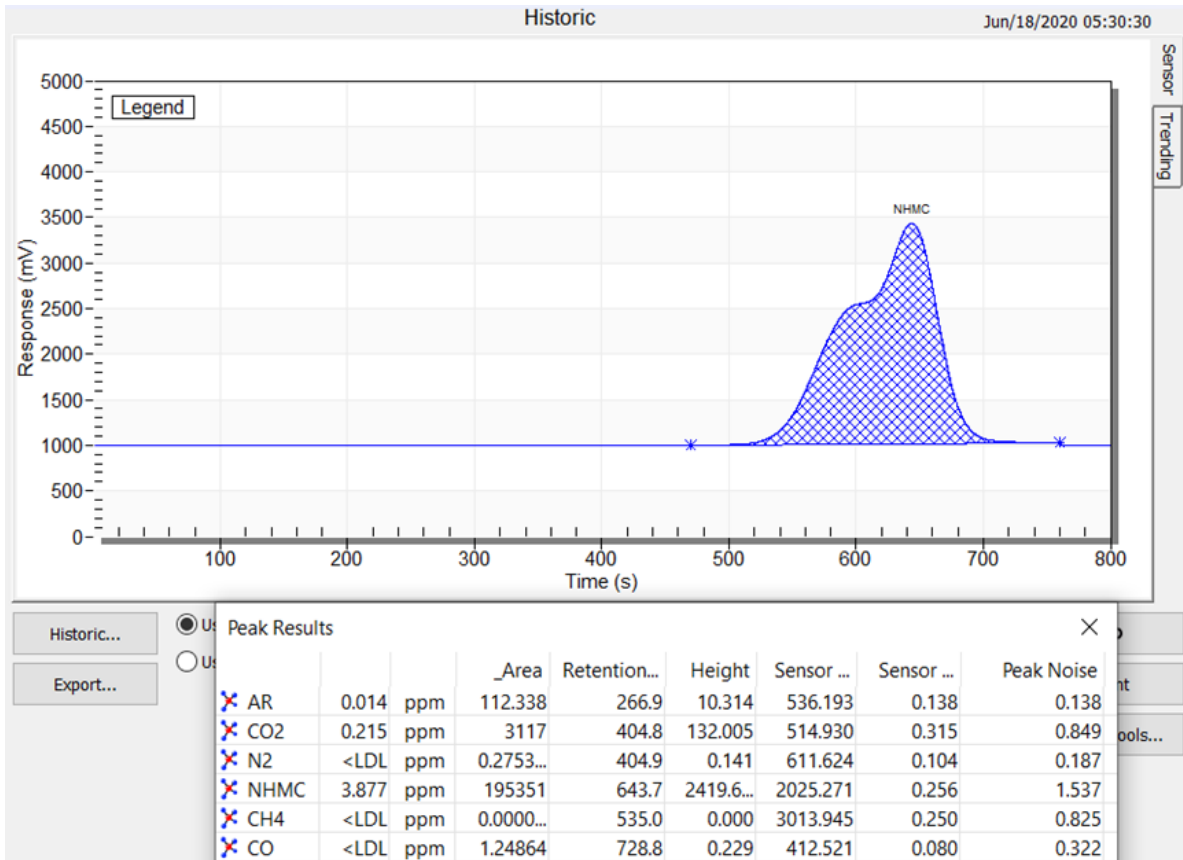

Sample : 500ppb NMHC(C3H8) Balance H2

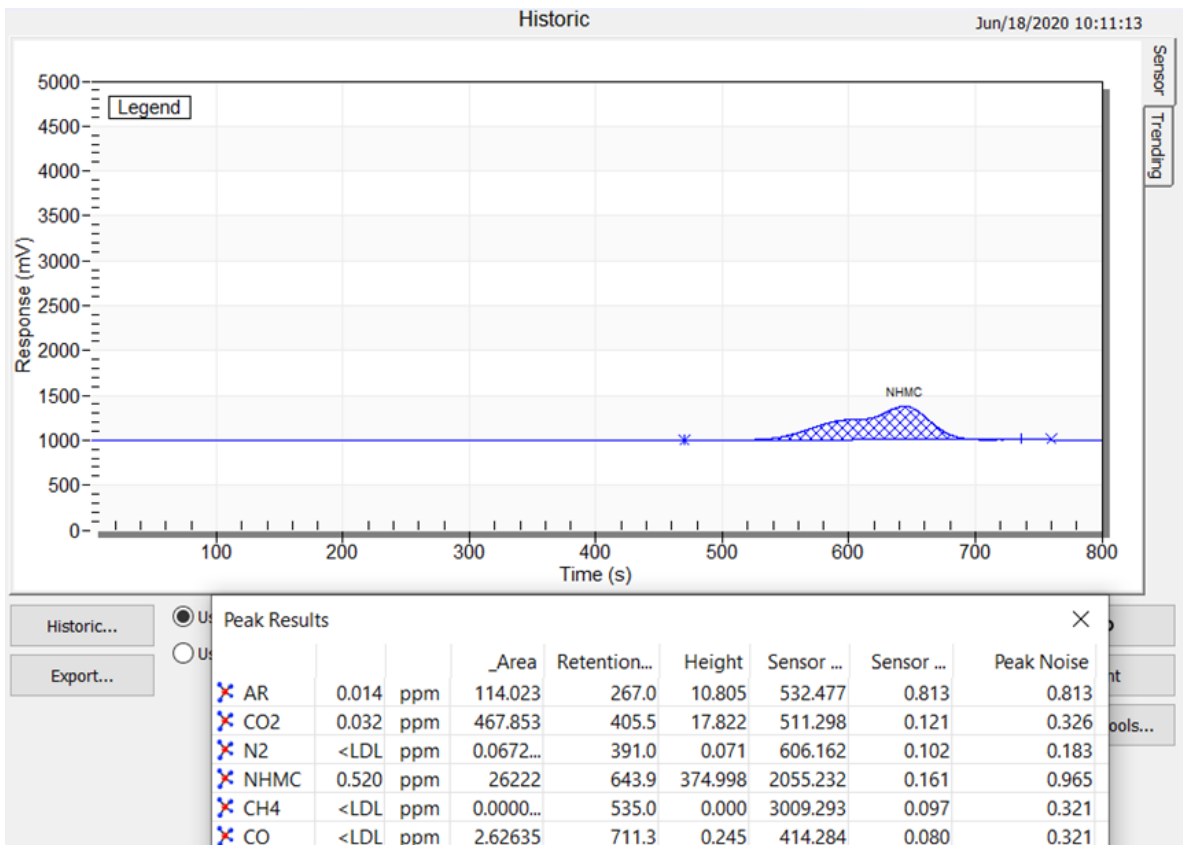

Chromatograms : GC#2/Channel 3

Sample : 50ppm He Balance H2

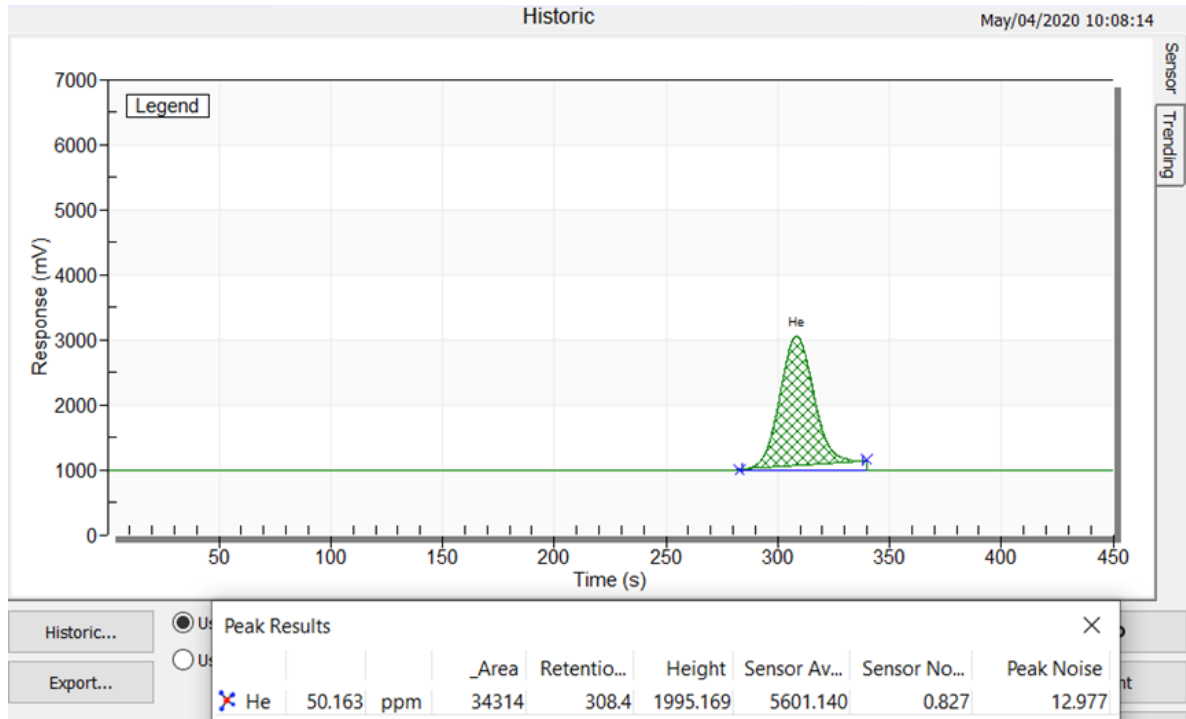

3.0 APPLICATION NOTES

LDL :

Component	Concentration (ppb)	Peak height (mV)	Noise (mV)	LDL (3x Noise) (ppb)
N2	565	401	0.349	1.48
CO2	395	301	0.376	1.48
CH4	439	324	0.889	3.61
CO	421	259	0.345	1.68
Ar	514	342	0.107	0.48
NMHC	520	375	0.965	4.01
He	50(ppm)	1995	12.97	1.00(ppm)

Note: other LDL could be obtained with different injection volume and chromatographic condition

Stability :

Sample : 1ppm Ar-N2-NMHC-CO2-CH4-CO Balance H2

Start	AR	N2	NMHC	CO2	CH4	CO
2020-05-21 20:16	0.889 ppm	1.171 ppm	0.564 ppm	1.045 ppm	1.161 ppm	1.042 ppm
2020-05-21 20:02	0.889 ppm	1.174 ppm	0.567 ppm	1.045 ppm	1.161 ppm	1.042 ppm
2020-05-21 19:49	0.886 ppm	1.174 ppm	0.568 ppm	1.044 ppm	1.161 ppm	1.042 ppm
2020-05-21 19:35	0.886 ppm	1.174 ppm	0.571 ppm	1.046 ppm	1.159 ppm	1.041 ppm
2020-05-21 19:21	0.886 ppm	1.174 ppm	0.573 ppm	1.044 ppm	1.160 ppm	1.042 ppm
2020-05-21 19:08	0.887 ppm	1.176 ppm	0.573 ppm	1.042 ppm	1.163 ppm	1.043 ppm

IMPURITIES	Ar	N2	NMHC	CO2	CH4	CO
Average (ppb)	887.2	1173.8	569.3	1044.3	1160.8	1042
Sigma σ (ppb)	1.47	1.60	3.61	1.37	1.33	0.63
CV (%)	0.17	0.14	0.63	0.13	0.12	0.06
CV x 3 (%)	0.5	0.41	1.90	0.39	0.35	0.18
Status	pass	pass	pass	pass	pass	pass
Repeatability (%)	0.2	0.1	0.6	0.1	0.1	0.1

Using a series of 6 consecutive analysis, the repeatability conformity test must be below 5% considering a value of 3 times the coefficient of variation (CV) to be accepted.

The repeatability % is obtained by applying the sigma of the 6 consecutive analysis on the average of these 6 same analysis.

The test has been performed at the bottom of the scale which is the most rigorous concentration to get a good repeatability. Running such repeatability test at higher concentration is just easier to get a better repeatability. It demonstrates the performance of the system in terms of repeatability at very low concentration.

Chromatograms : GC#3/Channel 1

Sample: 100.000% H2

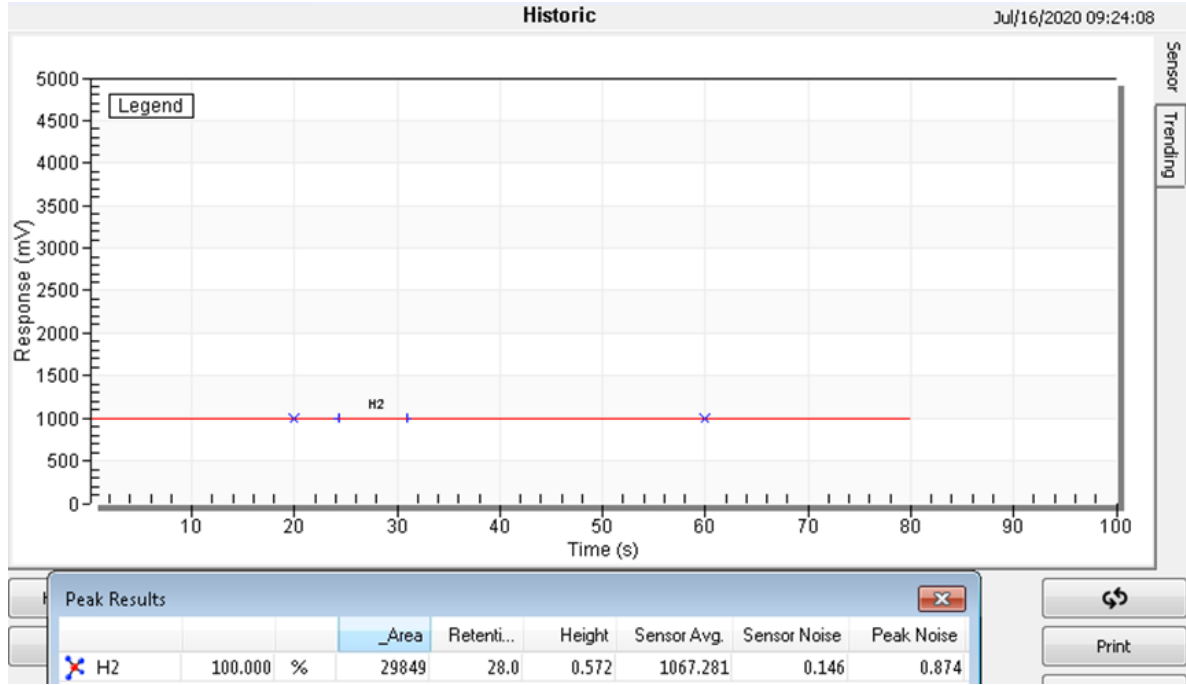

Sample: 99.989% H2

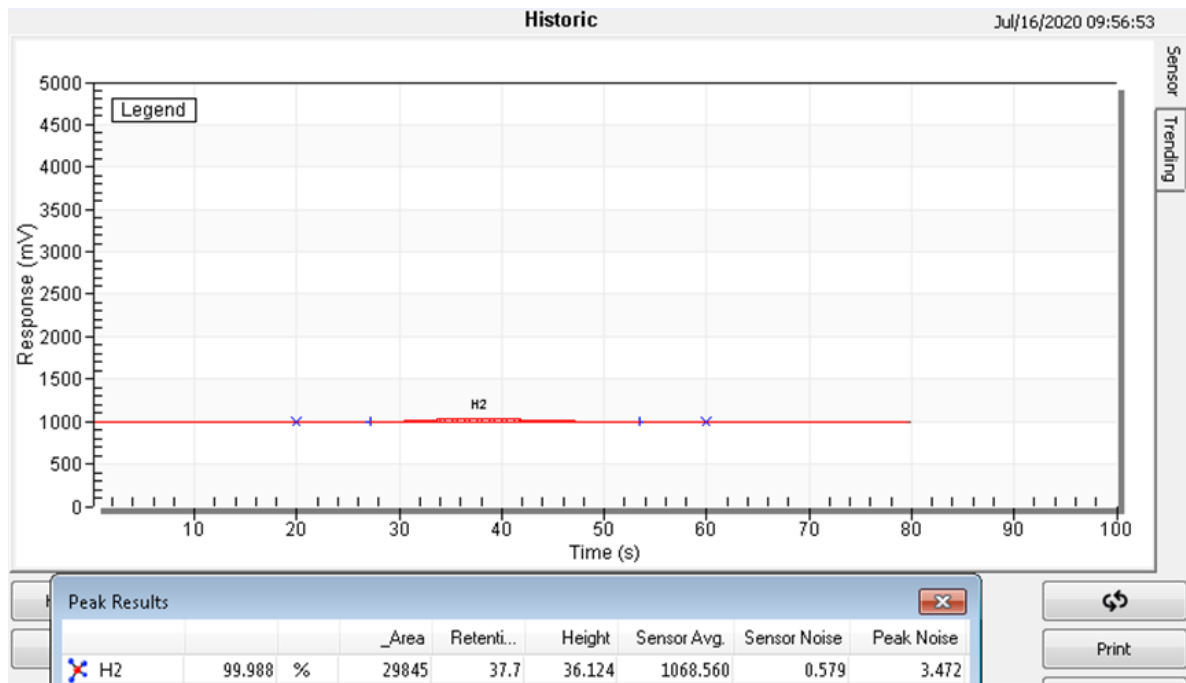

3.0 APPLICATION NOTES

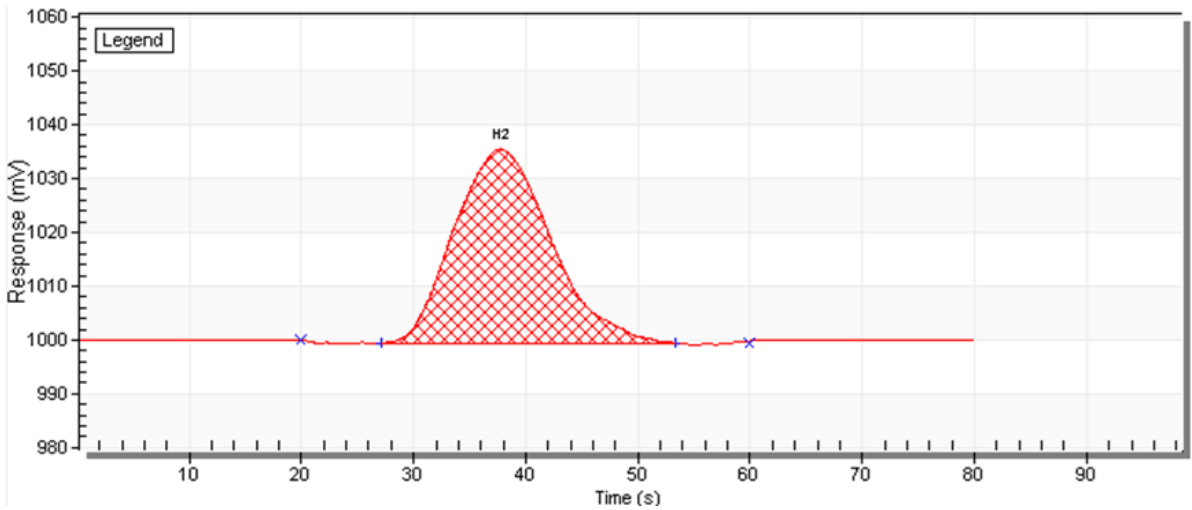

Sample: 99.890% H2

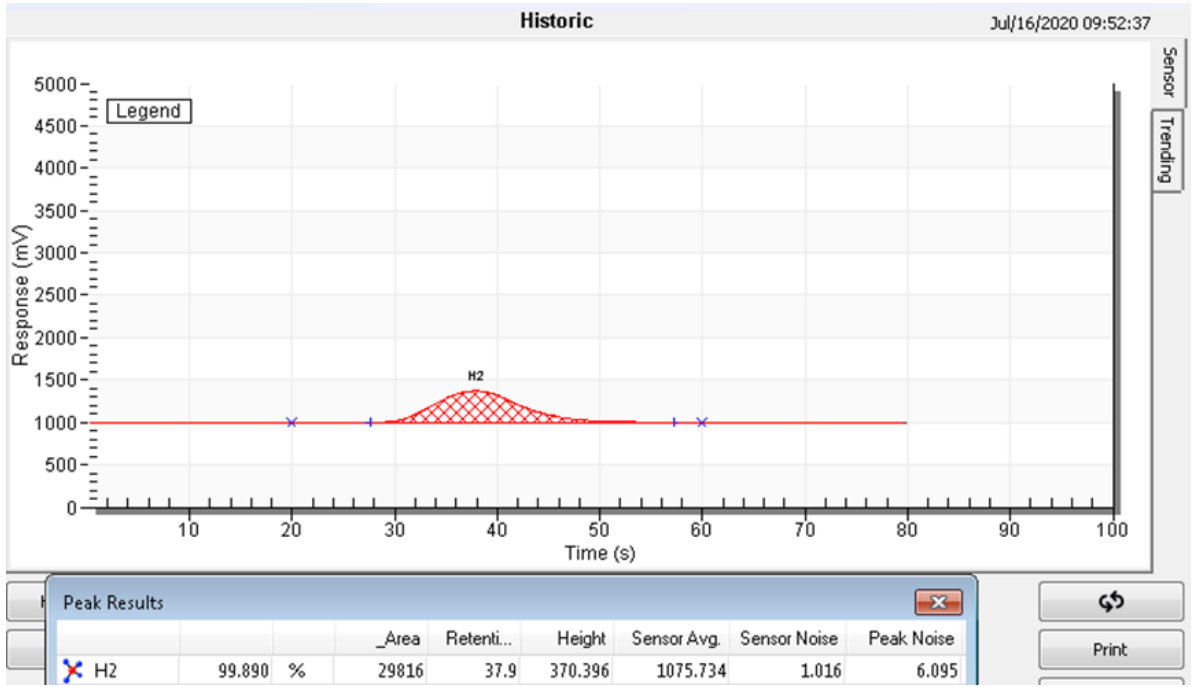

Sample: 99.837% H2

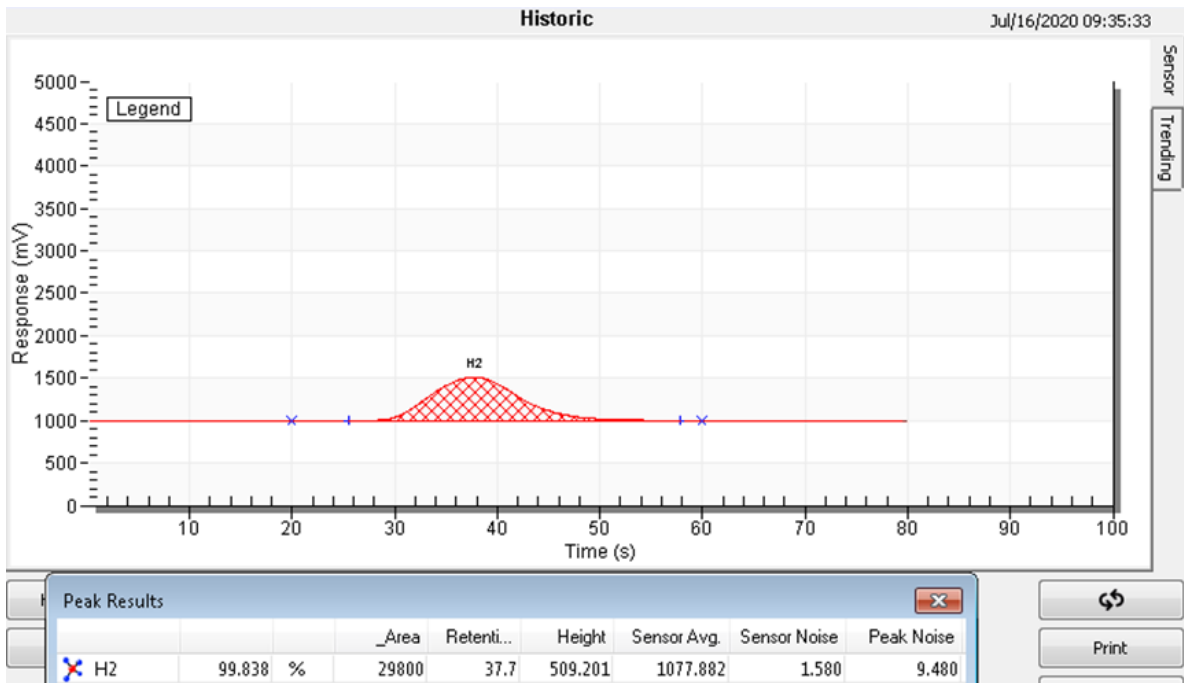

Sample: 99.541% H2

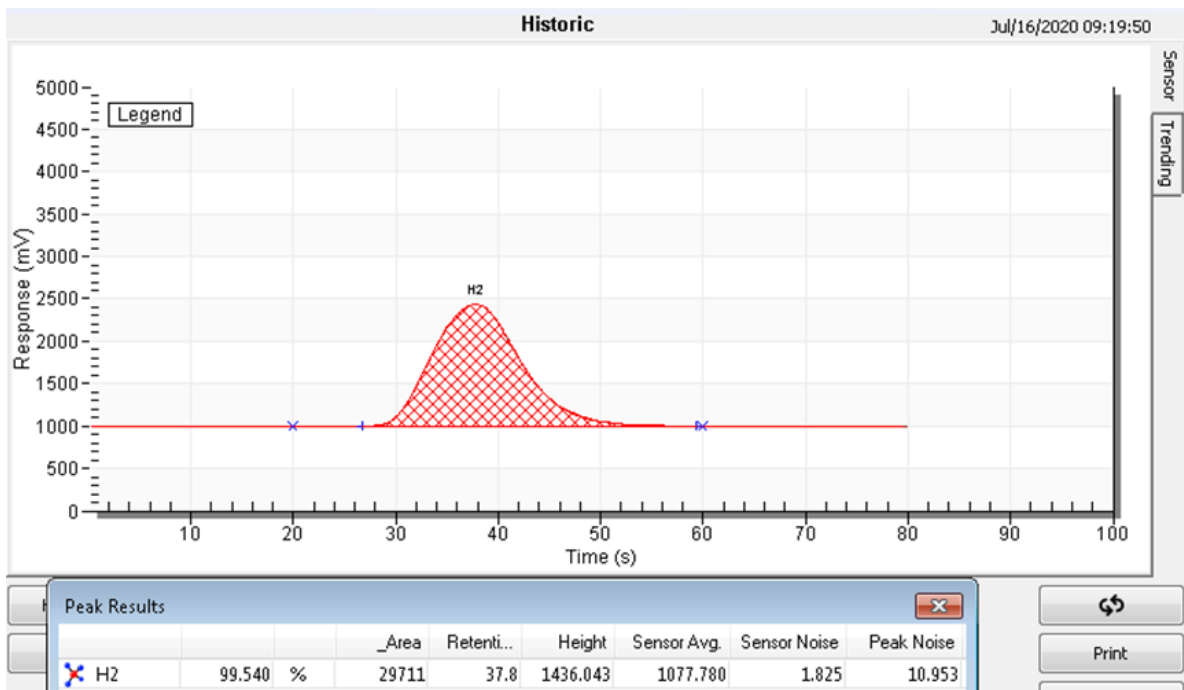

Sample: 99.055% H2

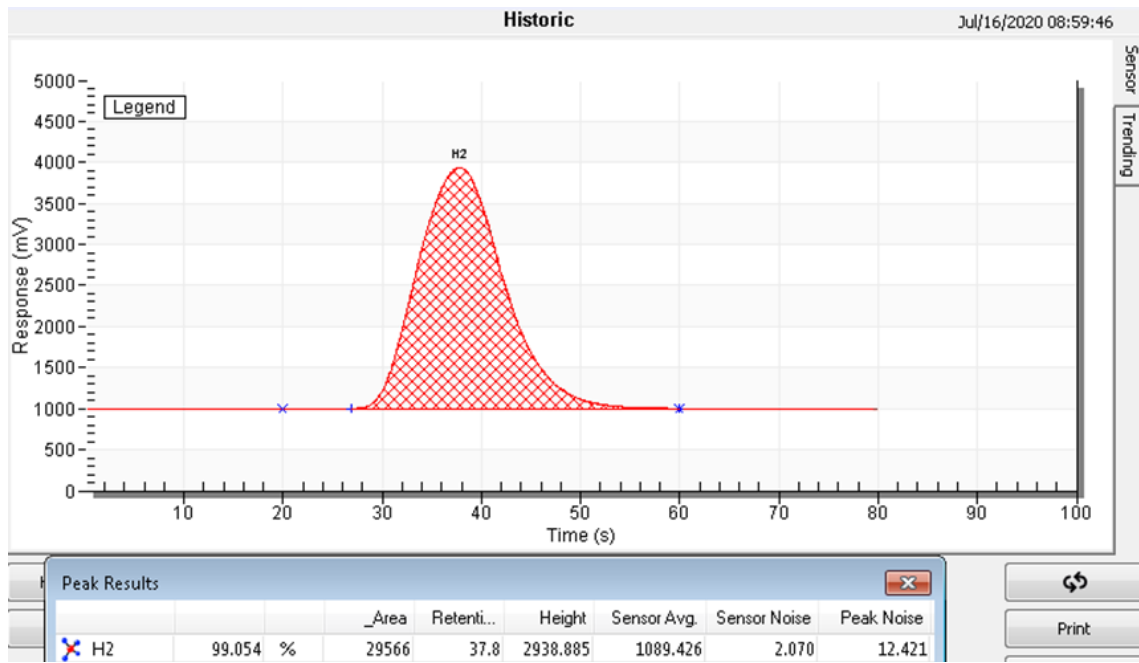

LDL /Accuracy :

The concentration in % is obtained by dilution H2/N2. The difference between 100% H2 and the diluted H2 concentration is applied.

Component	Concentration (%)	Peak height (mV)	Noise (mV)	LDL (3x Noise) (%)	Accuracy (3x Noise) (%)
H2	0.012	36.124	3.472	0.003	+/-0.0015

Note: other LDL & accuracy could be obtained with different injection volume and chromatographic condition





Stability :

Sample : 99.750% H2





Start	H2
2020-07-16 10:28	99.756 %
2020-07-16 10:26	99.756 %
2020-07-16 10:25	99.756 %
2020-07-16 10:24	99.756 %
2020-07-16 10:22	99.756 %
2020-07-16 10:21	99.756 %
2020-07-16 10:19	99.756 %
2020-07-16 10:18	99.755 %
2020-07-16 10:16	99.755 %
2020-07-16 10:15	99.755 %
2020-07-16 10:14	99.755 %

CERTIFICATIONS

ATEX

 IECEx TEST REPORT of NATIONAL DIFFERENCES	
ExTR Reference Number.....:	CA/QPS/ExTR19.0028/00
ExTR Free Reference Number.....:	X35775-1
Compiled by + signature (ExTL).....:	Alenko Vranes 
	Kerry Nice, A.Sc.T. 
Reviewed by + signature (ExTL).....:	Rob Kohuch, P. Eng. 
Date of issue.....:	January 24, 2020
Ex Testing Laboratory (ExTL).....:	QPS Evaluation Services Inc.
Address.....:	81 Kelfield St, Unit 8, Toronto, ON M9W 5A3
Applicant's name.....:	LDetek Inc.
Address.....:	990 Rue Monfette E Thetford Mines, QC G6G 7K6, Canada
Country/Region.....:	Europe: Switzerland (CH), Czech Republic (CZ), Germany (DE), Denmark (DK), Finland (FI), France (FR), United Kingdom (GB), Hungary (HU), Italy (IT), the Netherlands (NL), Norway (NO), Romania (RO), Sweden (SE) and Slovenia (SI)
Standards.....:	EN 60079-0:2012/A11:2013; EN 60079-2:2007; EN 60079-7:2007; EN 60079-11:2012; EN 60079-18:2009.
Test Report Form Number.....:	ExTR National Differences_3 (released 2018-02)
<p>Copyright © 2018 International Electrotechnical Commission System for Certification to Standards Relating to Equipment for use in Explosive Atmospheres (IECEx System), Geneva, Switzerland. All rights reserved.</p> <p>This blank publication may be reproduced in whole or in part for non-commercial purposes as long as the IECEx System is acknowledged as copyright owner and source of the material. The IECEx system takes no responsibility for, and will not assume liability for, damages resulting from the reader's interpretation of the reproduced material due to its placement and context.</p>	

No national differences between below European standards and International standards		Verdict
European Standards:	International Standards:	
EN 60079-2:2007	IEC 60079-2:2007 Edition 5.0	Pass
EN 60079-7:2007	IEC 60079-7:2006 Edition 4.0	Pass
EN 60079-11:2012	IEC 60079-11:2011 Edition 6.0	Pass
EN 60079-18:2009	IEC 60079-18:2009 Edition 3.0	Pass

		IECEX TEST REPORT COVER
ExTR Reference Number.....:	CA/QPS/ExTR 19.0028/00	
ExTR Free Reference Number.....:	X35775-1	
Compiled by + signature (ExTL).....:	Alenko Vranes	
	Kerry Nice, A.Sc.T.	
Reviewed by + signature (ExTL).....:	Rob Kohuch, P. Eng.	
Approved by + signature (ExCB).....:	Dave Adams, P. Eng.	
Date of issue.....:	February 21, 2020	
Ex Testing Laboratory (ExTL).....:	QPS Evaluation Services Inc.	
Address.....:	81 Kelfield St. Unit 7-9, Toronto, Ont. M9L 1S1, Canada	
Ex Certification Body (ExCB).....:	QPS Evaluation Services Inc.	
Address.....:	81 Kelfield St. Unit 7-9, Toronto, Ont. M9L 1S1, Canada	
Applicant's name.....:	LDetek Inc.	
Address.....:	990 Rue Monfette E Thetford Mines, QC G6G 7K6, Canada	
Standards associated with this ExTR package.....:	IEC 60079-0:2011, Edition 6.0 IEC 60079-2:2007, Edition 5.0 IEC 60079-7:2008, Edition 4.0 IEC 60079-11:2011, Edition 6.0 IEC 60079-18:2009, Edition 3.0	
Clauses considered.....:	All clauses considered	
Related Amendments, Corrigenda or ISHs.....:	All items are considered	
Test item description.....:	Gas Chromatograph MultiDetek 2 EX	
Model/type reference.....:	MultiDetek Ex	
Code (e.g. Ex __ II__ T_).....:	Ex eb ib mb pxb IIB+H2 T4 Gb	
Rating.....:	MultiDetek 2 EX	
	Purge Controller Power: 230 V AC, 47 – 63 Hz, 660 Watts	
	Maximum sample gas pressure: 689 mbar (10 psi)	
	Minimum purge flow: 120 l/min	
	Minimum purge time: 78 minutes	
	Maximum overpressure: 6.7 mbar	
	Minimum overpressure: 1.24 mbar	
	Maximum supply air pressure: 6.9 bar	
	Minimum supply air pressure: 1.4 bar	
	Door clamps tightening torque: 3.4 – 3.9 Nm	



IECEX Test Report Summary

INTERNATIONAL ELECTROTECHNICAL COMMISSION
IEC Certification System for Explosive Atmospheres

for rules and details of the IECEx Scheme visit www.iecex.com

ExTR Ref. No.:	CA/QPS/ExTR19.0028/00	Page 1 of 1
ExTR Free Ref. No.:	X35775-1	Status: Issued
List of Standards Covered:	IEC 60079-0:2011 Edition:6.0, IEC 60079-11:2011 Edition:6.0, IEC 60079-18:2009 Edition:3, IEC 60079-2:2007-02 Edition:5, IEC 60079-7:2006-07 Edition:4	Date of issue: 2020-02-21
Issuing ExTL:	QPS - QPS	
Endorsing ExCB:	QPS - QPS	
Manufacturer:	LDetek Inc. 990 Rue Monfette E Thetford Mines G6G 7K6 QC	
Location of Manufacturer:	Canada	
Ex Protection:	Ex eb ib mb pxb IIC T4 Gb	
Ratings:	115 V AC, 25 A, 50/60 Hz IP55	
Equipment:	Gas Chromatograph	
Model Reference:	MultiDetek 2 EX	
Related IECEx Certificates:	IECEX QPS 19.0032X Issue 0	
Comments:		

CE

In compliance with EMC directive 2004/10EC, EN 61000-6-2:2005 for immunity & EN 61000-6-4:2007 for emissions.

File No. 53220 / EMC Test Report

Test name Standard	Limit Test level	EUT	Results
Measurement of conducted emissions CISPR 22: 2008	Class A	E35421 E35422 E35423	Pass
Measurement of radiated emissions CISPR 22: 2008, up to 6 GHz	Class A	E35421 E35422	Pass
Measurement of conducted emissions FCC Part 15: 2015, Subpart B	Class A	E35421 E35422 E35423	Pass
Measurement of radiated emissions FCC Part 15: 2015, Subpart B, up to 8 GHz	Class A	E35421 E35422	Pass
Radiated electromagnetic field immunity – radio frequencies IEC 61000-4-3: 2006 A1: 2007 A2: 2010	10 V/m 80-1000 MHz 3 V/m 1.4-2.7 GHz	E35421 E35422	Pass
Conducted immunity IEC 61000-4-6: 2008	10 V power	E35421 E35422	Pass
Electrostatic discharge immunity IEC 61000-4-2: 2008	±4 kV contact ±8 kV air	E35421 E35422	Pass
Electrical fast transient immunity IEC 61000-4-4: 2012	±2 kV power	E35421 E35422	Pass
Surge immunity IEC 61000-4-5: 2005	±1 kV L - L ±2 kV L - Ground	E35421 E35422	Pass
Magnetic field immunity IEC 61000-4-8: 2009	30 A/m / 50 Hz	E35421 E35422	Pass
Voltage dips, short interruptions and voltage variation immunity IEC 61000-4-11: 2004	0% - 1 cycle 40% - 10 cycles 70%, 25 cycles 0% - 250 cycles	E35421 E35422	Pass

CONCLUSION

The MultiDetek3 analyzer can measure all the contaminants at the required limit of detection, with the appropriated repeatability and linearity by combining its PlasmaDetek2 (patented) with TCD and quartz crystal sensors all in one system. The modularity of the instrument gives the ability to adapt the analyzer as per your requirements. The system is compact and rackmount. It can be configured for any safe area using the LDRack integration solution. When an Ex-proof area installation is required, then our certified pressurized enclosure for Ex-proof area is used. With our temperature-controlled solution configured for outdoor temperature going from -30C to 40C, our system can be used for any indoor or outdoor installations. A one source manufacturer to provide a certified solution for measuring fuel cell hydrogen as per the industry standard.

REFERENCES

Hydrogen Fuel Quality for Fuel Cell Vehicles

SAE J2719 SEP2011

<http://www.sae.org>

Design report for quartz crystal sensor integrated in the MultiDetek3 GC for trace moisture analysis :

http://www.ldetek.com/uploads/cgblog/id53/Trace_moisture_analysis.pdf

EMC test report for MultiDetek3 GC and LDP1000 gas purifier

CRIQ file 670-53220

ATEX & IECEx test reports and certifications

QPS : ExTR Reference No. CA/QPS/ExTR19.0028/00



3.0 APPLICATION NOTE

3.8 FOOD AND BEVERAGE



3.0 APPLICATION NOTES

APPLICATION NOTE

LD16-12



Trace impurities in Carbon Dioxide for beverage and food packaging industry



▲ MultiDetek2

▲ PlasmaDetek2

With regards to the beverage industry, the dissolved Carbon Dioxide which is used as carbonic acid gives a pleasantly acidic flavour and a nice mouth-feel when drinking. When it is not present, the drinks taste flat. Being used in many different fields of food and beverage, the CO₂ quality management is essential to meet the market requirements.

The CO₂ is produced from different techniques such as fermentation, combustion, ammonia/hydrogen production and others. It is required by the industry, especially for bottlers to control the supply chain by monitoring the CO₂ purity allowing maintenance of the product quality.

LDETEK SOLUTION:

Using the PlasmaDetek2(PED) plasma detector and the MultiDetek2 compact gas chromatograph, the analysis of the most critical trace impurities in carbon dioxide can be achieved in one unit with a single detection technology (PED).

By default, the configuration has 3 channels to cover the analysis of Benzene, Acetaldehyde, Nitrogen and Carbon Monoxide. If additional options for the analysis of Methanol, Sulfurs and Hydrocarbons are required, then channels 4, 5 and 6 are added in the same instrument.

Channel#1: 0-100ppb Benzene

Channel#2: 0-1000ppb Acetaldehyde

Channel#2: 0-120ppm Nitrogen & 0-10ppm Carbon Monoxide

Also integrated inside the MultiDetek2, a dilution system allows generating for a span calibration gas at ppb level for the low concentration impurities. This option gives you the capacity to use a standard certified calibration gas at higher concentrations, which is usually lower in cost and easier to get, also that generates a low ppb calibration gas. The dilution system is designed for low gas consumption, high accuracy/stability and is automatically handled by the interface during span calibration process.

For multiple streams requirement, the LDGSS high purity stream selector system can be combined with the MultiDetek2 to offer all the flexibility to switch streams and even run stream sequences analysis as required.

RESULTS:

The results show the performances of the system for a standard configuration used to measure Benzene, Acetaldehyde, Nitrogen and Carbon Monoxide in Carbon Dioxide.

It displays details about the calibration chromatogram, some examples of low ppb chromatograms for each impurity, the IdI chart for noise/response calculation, the stability and the linearity curves.

SPAN CALIBRATION CHROMATOGRAM:

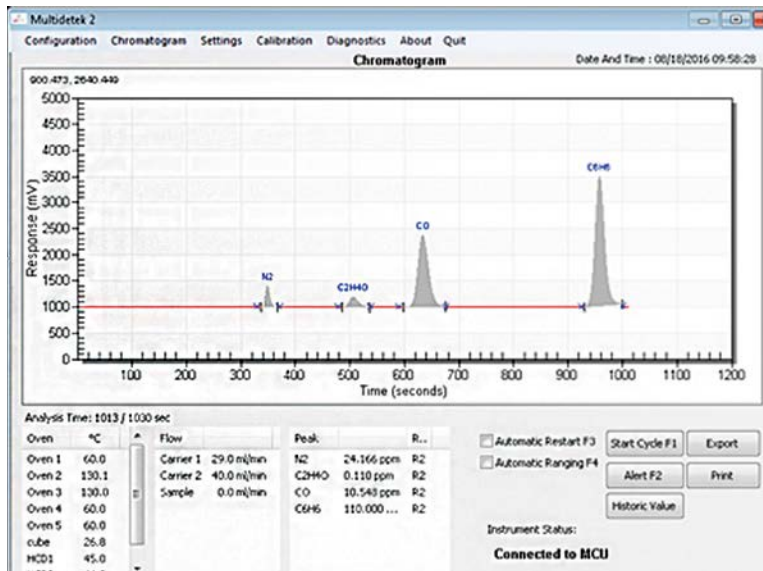

Figure 1: Chromatogram of a gas mixture containing 24ppm nitrogen, 110ppb acetaldehyde, 10.5ppm carbon monoxide and 110ppb benzene in a balance gas carbon dioxide.

LOW PPB CHROMATOGRAM:

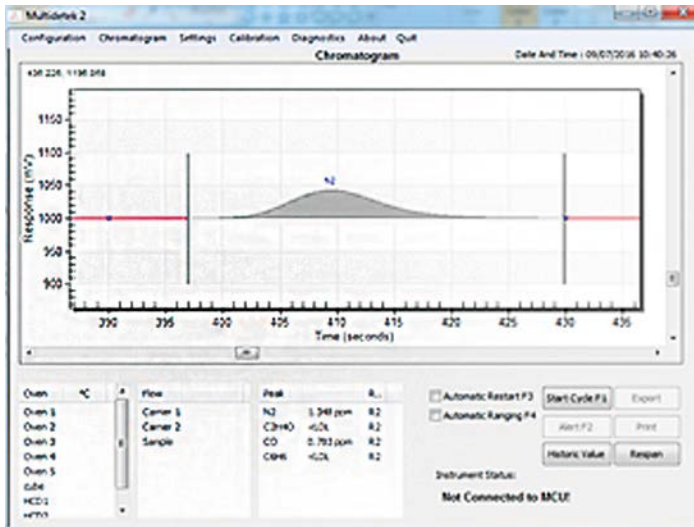

Figure 2:
Chromatogram of 1348 ppb Nitrogen in Carbon dioxide

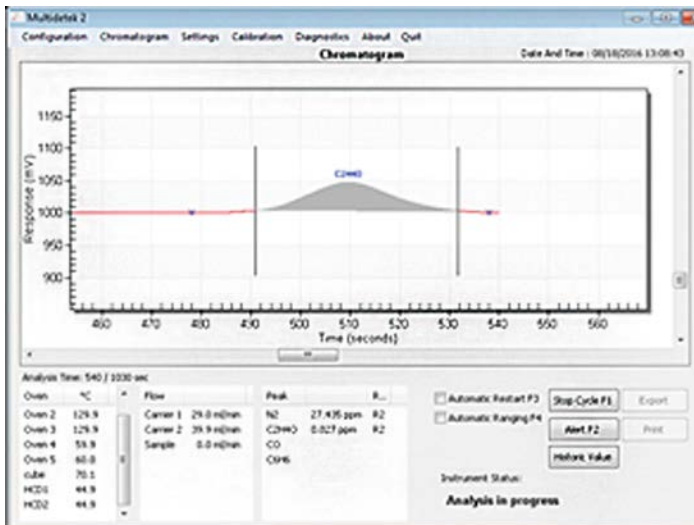

Figure 3:
Chromatogram of 27ppb Acetaldehyde in Carbon dioxide

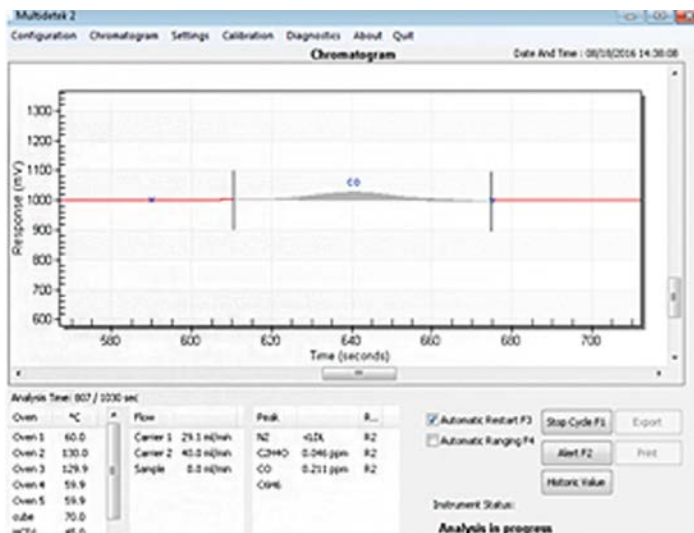

Figure 4:
Chromatogram of 211ppb Carbon monoxide in Carbon dioxide

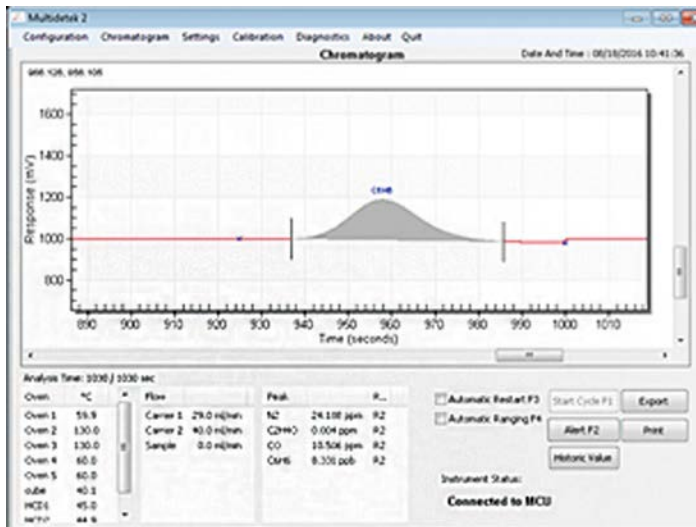

Figure 5: Chromatogram of 8.331ppb Benzene in Carbon dioxide

LDL calculation

COMPONENT	CONCENTRATION	PEAK HEIGHT	NOISE	LDL (3X NOISE)
Nitrogen	1348 ppb	49.3 mV	0.2 mV	16.4 ppb
Acetaldehyde	27 ppb	49.1 mV	1.1 mV	1.8 ppb
Carbon monoxide	211 ppb	35.4 mV	1.6 mV	28.6 ppb
Benzene	8.331 ppb	215.7 mV	2.1 mV	0.243 ppb

Note: other LDL could be obtained with different injection volume and chromatographic conditions

STABILITY:

Date/Time	N2	C2H6O	CO	C6H6
Aug/18/2016 08:07:47	24.596	0.783	10.601	57.229
Aug/18/2016 07:50:32	24.678	0.783	10.601	57.165
Aug/18/2016 07:33:17	24.606	0.784	10.597	57.110
Aug/18/2016 07:16:00	24.588	0.784	10.615	57.026
Aug/18/2016 06:58:45	24.579	0.784	10.613	57.102
Aug/18/2016 06:41:29	24.617	0.783	10.613	56.838
Aug/18/2016 06:24:13	24.768	0.782	10.617	56.933
Aug/18/2016 06:06:57	24.742	0.781	10.617	56.960
Aug/18/2016 05:49:41	24.627	0.780	10.601	56.890
Aug/18/2016 05:32:25	24.720	0.780	10.599	56.752
Aug/18/2016 05:15:10	24.687	0.780	10.599	56.860
Aug/18/2016 04:57:54	24.762	0.780	10.596	56.920
Aug/18/2016 04:40:38	24.797	0.780	10.599	56.879
Aug/18/2016 04:23:22	24.827	0.780	10.599	57.006
Aug/18/2016 04:06:06	24.728	0.780	10.604	56.974

Figure 6: The results show the stability over a period of 15 consecutive cycles. The units for nitrogen, acetaldehyde and carbon monoxide are ppm and the unit for benzene is ppb

LINEARITY:

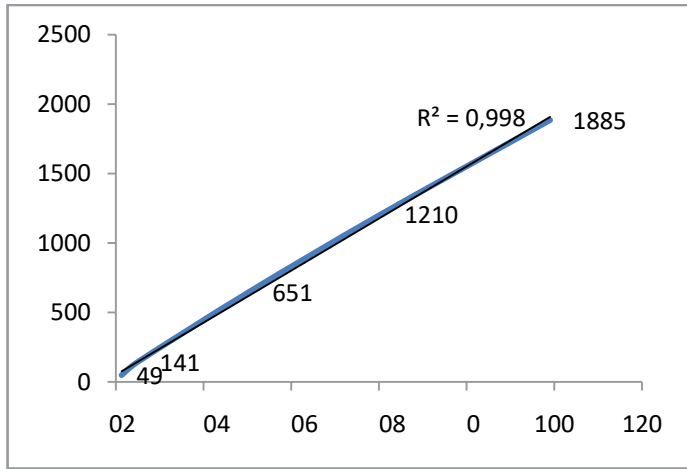

N2 CONCENTRATION	N2 RESPONSE
1.348 ppm	49 mV
4.856 ppm	141 mV
30.518 ppm	651 mV
60.6 ppm	1210 mV
99 ppm	1885 mV

Figure 7:
Impurity : nitrogen

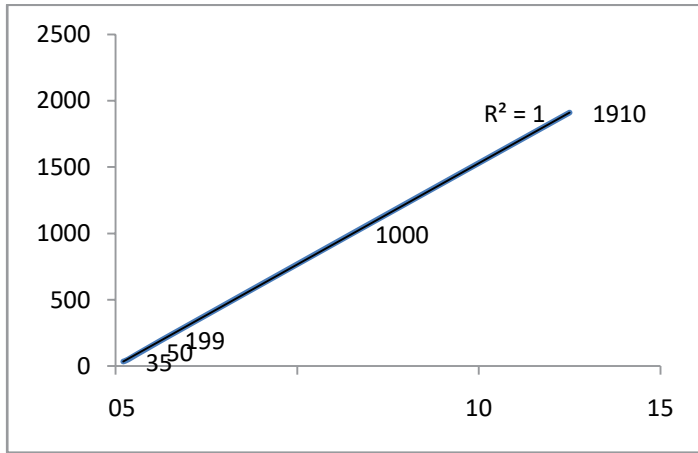

CO CONCENTRATION	CO RESPONSE
0.211 ppm	35 mV
0.343 ppm	50 mV
1.285 ppm	199 mV
6.521 ppm	1000 mV
12.5 ppm	1910 mV

Figure 8:
Impurity : carbon monoxide

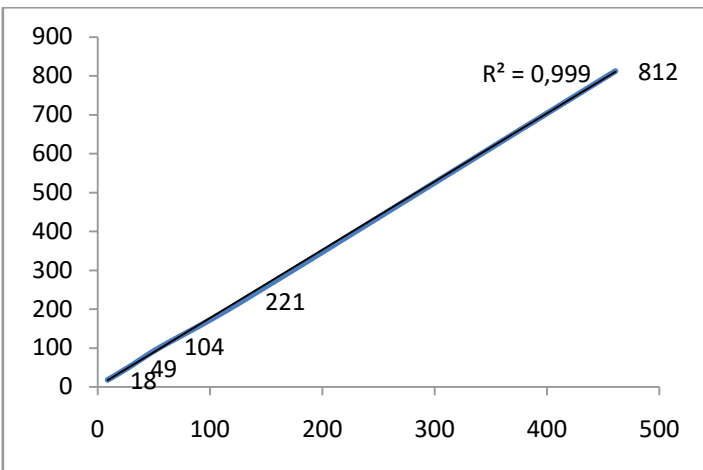

ACETALDEHYDE CONCENTRATION	ACETALDEHYDE RESPONSE
9 ppb	18 mV
27 ppb	49 mV
57 ppb	104 mV
129 ppb	221 mV
461 ppb	812 mV

Figure 9:
Impurity : acetaldehyde

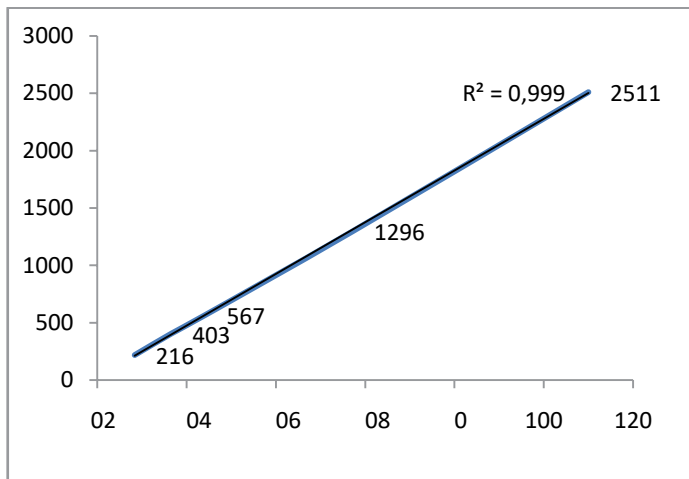

BENZENE CONCENTRATION	BENZENE RESPONSE
8.331 ppb	216 mV
16.532 ppb	403 mV
24.212 ppb	567 mV
57.158 ppb	1296 mV
110 ppb	2511 mV

Figure 10:
Impurity : benzene

CONCLUSION:

Our solution detects traces of gas impurities required by the food and beverage industry for Carbon Dioxide. The complete spectrum analysis can be covered with one single MultiDetek2 unit using the PlasmaDetek2 detection technology. It can detect sub ppb concentrations that are required for this type of application. It combines the analysis of different gas types that are usually very difficult to do with the same instrument. The MultiDetek2 offers a solution with an integrated PC interface that offers standard communication protocols compatible with all market standards.

APPLICATION NOTE

LD17-02



Gas analysis for wineries



In the wineries for proper wine production, inert gases like nitrogen, carbon dioxide and argon are used for sparging, blanketing as counter-pressure to move wine(usually from barrels), as well as to flush transfer lines and tanks prior to moving wine or juice. Sparging involves the introduction of a stream of very fine gas bubbles to help add or remove dissolved Oxygen or CO₂. Blanketing partially-filled tanks attempts to maintain an inert gas layer above the wine/ juice surface in the hope of minimizing wine/air contact. The main reason for the use of inert gassing is to prevent the growth of aerobic microorganisms in the wine. The gas chromatography is a well known analysis technique to ensure the measurement of the purity and to control the production of wine to achieve the best quality.

LDETEK SOLUTION:

Using the PlasmaDetek2(PED) plasma detector and the MultiDetek2 compact gas chromatograph, the analysis of the most critical impurities in carbon dioxide, nitrogen and argon used in wine production can be achieved with a single unit.

The configuration uses one channel for trace analysis of O₂-N₂-CO₂-Ethanol with the PlasmaDetek2(PED) optimized for low concentrations. The second channel is configured with a conventional TCD optimized for high concentrations in % for O₂-N₂-CO₂-Ethanol. This dual detectors configuration allows covering a wide analysis range.

- ▶ **Channel#1:** Trace O₂-N₂-CO₂-Ethanol
- ▶ **Channel#2:** % O₂-N₂-CO₂-Ethanol

Since the sample volume and pressure for this type of application is limited, the MultiDetek2 is equipped with a mini pump that sucks the right amount of sample to fill the sampling loops correctly prior to run the analysis. The parameters can be adjusted by the user easily from the software interface depending of the sample line selected. The sample collection system is designed(leak free) for low O₂-N₂ analysis performances without air contamination.

The advantages of our solution over standard chromatograph systems is based on the use of Argon as carrier gas with the PlasmaDetek2. It allows an easy GC configuration that can measure O₂-N₂ with a single column configuration, having low operating cost and getting good sensitivity at ppb level. This isn't feasible with standard ionisation detector because of the use of Helium as carrier gas, the O₂ analysis becomes not possible and the operating cost are higher.

RESULTS

The results show the performances of the system for each pre configured method used to measure impurities in each sample type.

Method #1 is configured and calibrated for trace (Ar+O₂)-CO₂-ethanol in sample gas nitrogen.

Method #2 is configured and calibrated for trace N₂-CO₂-ethanol in sample gas argon.

Method #3 is configured and calibrated for percent (Ar+O₂)-N₂-ethanol in sample gas carbon dioxide.

Span calibration chromatogram for Nitrogen method:

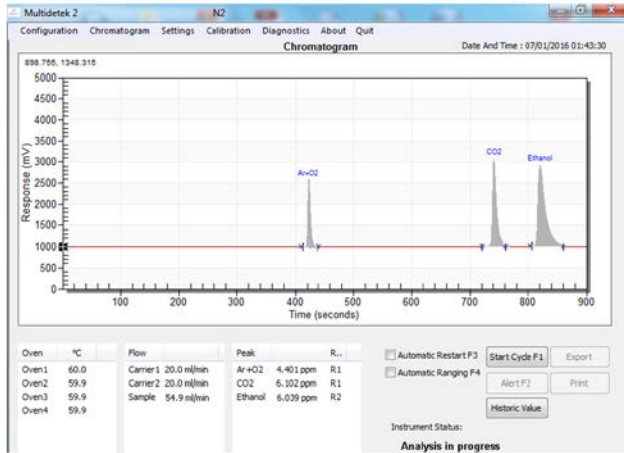

Chromatogram of a gas mixture containing 4.4ppm O₂, 6.1ppm CO₂ and 6.0ppm ethanol in a balance gas Nitrogen.

Span calibration chromatogram for Argon method:



Chromatogram of a gas mixture containing 5.7ppm N₂, 6.1ppm CO₂ and 6.1ppm ethanol in a balance gas Argon.

Span calibration chromatogram for Carbon dioxide method:

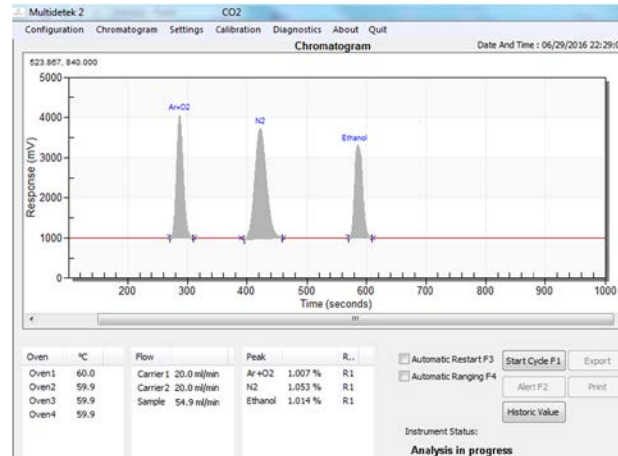

Chromatogram of a gas mixture containing 1% O₂, 1% N₂ and 1% ethanol in a balance gas Carbon dioxide.

CONCLUSION:

Our solution combines our PlasmaDetek2 for low ppb/ppm concentrations and a TCD for the percent concentrations. Having this dual detectors configuration, a wide range of analysis can be covered. The MultiDetek2 is configured with multiple methods depending of the requirements. It is easy for the user to simply load the proper method for his requirement. On request, additional impurities and methods can be added to the same system.

Our solution is robust and perfectly adapted for the gas analysis used in the wine production sector.

APPLICATION NOTE

LD17-04



Trace impurities in Carbon Dioxide for beverage and food packaging industry



▲ MultiDetek2

▲ PlasmaDetek2

With regards to the beverage industry, the dissolved Carbon Dioxide which is used as carbonic acid gives a pleasantly acidic flavour and a nice mouth-feel when drinking. When it is not present, the drinks taste flat. Being used in many different fields of food and beverage, the CO₂ quality management is essential to meet the market requirements.

The CO₂ is produced from different techniques such as fermentation, combustion, ammonia/hydrogen production and others. It is required by the industry, especially for bottlers to control the supply chain by monitoring the CO₂ purity allowing maintenance of the product quality.

LDETEK SOLUTION:

Following the application note LD16-12 this application note shows another configuration of the MultiDetek2 with PlasmaDetek2 also related to the beverage industry where the analysis of different components in carbon dioxide is realized.

This configuration has 3 channels to cover the analysis of benzene, hydrogen sulfide, nitrogen and oxygen. Additional channels can be added if analysis of more components is required. All the components are measured with one type detector PED using Helium as carrier gas.

- ▶ **Channel#1:** 0-1000ppb benzene
- ▶ **Channel#2:** 0-1000ppb hydrogen sulfide
- ▶ **Channel#3:** 0-10ppm oxygen and nitrogen

A FID analyser LD2000 is added to this solution for measuring THC on a scale of 0-10ppm

A TCD binary gas analyser LD8000 is added for measuring 98-100% CO₂ purity

A dewpoint meter LD500 is added for the analysis of moisture on a 0-10ppm scale

LDRACK CABINET:

All the instruments are integrated in the LDrack cabinet. A multiple streams selector system LDGSS selects the right gas lines for analysis. The stream selector can be controlled locally or remotely with the MultiDetek2 interface. The complete solution is configured with coated stainless steel tubing to ensure stability of the system. It reduces the risk of surface absorption, especially for the sulfur components.



MultiDetek2 compact GC with PED detector

LDGSS stream selector

LD8000 binary gas analyser with TCD detector

LD2000 THC gas analyser with FID detector

Compact LDP1000 gas purifier for carrier gas

LD500 dew point gas analyser with moisture detector. (mounted on the back side)

Extra sliding shelf for a keyboard

Robust sliding shelf system to give a full access to the instrument

RESULTS:

The results show the performances of the MultiDetek2 system for a standard configuration used to measure oxygen, nitrogen, benzene and hydrogen sulfide in Carbon Dioxide. The Idl and repeatability results are demonstrated.

Analysis of a gas mixture containing a certified concentration of trace O2-N2-C6H6-H2S-H2O in balance gas CO2

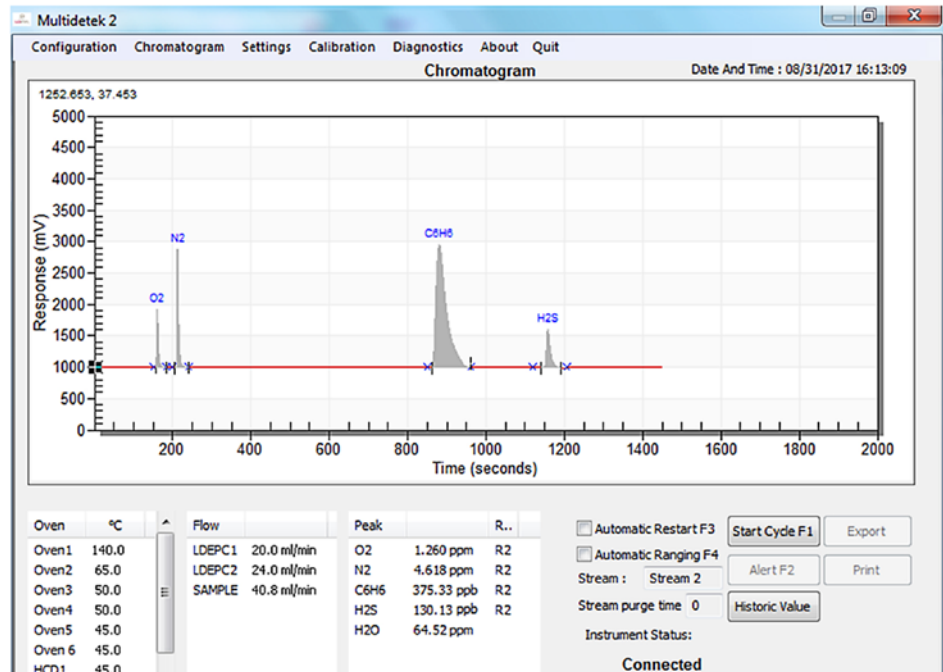

LDL:

COMPONENT	CONCENTRATION	PEAK HEIGHT	NOISE	LDL (3X NOISE)
Oxygen	1.260 ppm	987 mV	4.2 mV	16.0 ppb
Nitrogen	4.618 ppm	1961 mV	2.9 mV	20.4 ppb
Benzene	375.33 ppb	1987 mV	12.6 mV	7.14 ppb
Hydrogen sulfide	130.13 ppb	611 mV	12.9 mV	8.24 ppb

Note: other LDL could be obtained with different injection volume and chromatographic condition

REPEATABILITY:

The results below show the repeatability for each component. Three times of the percentage of coefficient of variation (3*CV %) for each component must be smaller than 5% to meet the requirements.

$$s = \sqrt{\frac{1}{N-1} \sum_{i=1}^N (x_i - \bar{x})^2}$$

COMPONENT	CV (%)	CV% x 3 < 5%
Oxygen	0.95	2.85
Nitrogen	0.66	1.98
Benzene	1.02	3.06
Hydrogen sulfide	0.74	2.22

Component : O2

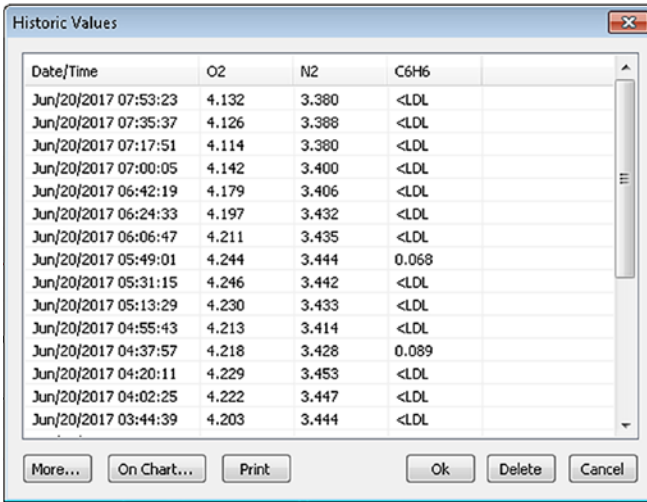

Historic Values window showing data for Component O2. The table contains 17 rows of data with columns for Date/Time, O2, N2, and C6H6. The O2 column values range from 4.126 to 4.222. The N2 column values range from 3.380 to 3.444. The C6H6 column values are mostly <LDL, with some numerical values like 0.068 and 0.089.

Date/Time	O2	N2	C6H6
Jun/20/2017 07:53:23	4.132	3.380	<LDL
Jun/20/2017 07:35:37	4.126	3.388	<LDL
Jun/20/2017 07:17:51	4.114	3.380	<LDL
Jun/20/2017 07:00:05	4.142	3.400	<LDL
Jun/20/2017 06:42:19	4.179	3.406	<LDL
Jun/20/2017 06:24:33	4.197	3.432	<LDL
Jun/20/2017 06:06:47	4.211	3.435	<LDL
Jun/20/2017 05:49:01	4.244	3.444	0.068
Jun/20/2017 05:31:15	4.246	3.442	<LDL
Jun/20/2017 05:13:29	4.230	3.433	<LDL
Jun/20/2017 04:55:43	4.213	3.414	<LDL
Jun/20/2017 04:37:57	4.218	3.428	0.089
Jun/20/2017 04:20:11	4.229	3.453	<LDL
Jun/20/2017 04:02:25	4.222	3.447	<LDL
Jun/20/2017 03:44:39	4.203	3.444	<LDL

Component : N2

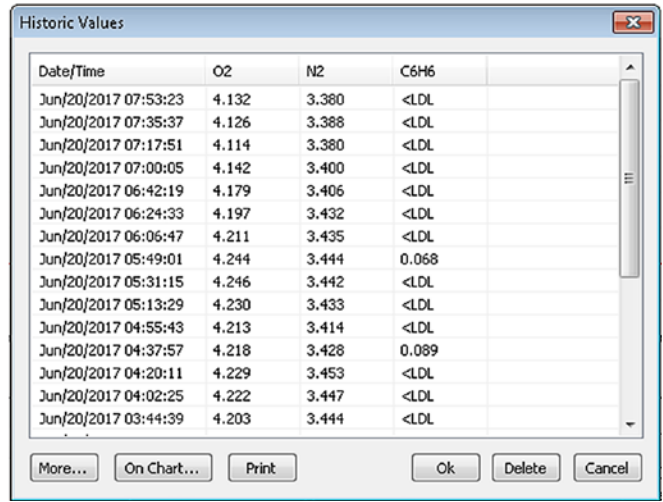

Historic Values window showing data for Component N2. The table contains 17 rows of data with columns for Date/Time, O2, N2, and C6H6. The O2 column values range from 4.126 to 4.222. The N2 column values range from 3.380 to 3.444. The C6H6 column values are mostly <LDL, with some numerical values like 0.068 and 0.089.

Date/Time	O2	N2	C6H6
Jun/20/2017 07:53:23	4.132	3.380	<LDL
Jun/20/2017 07:35:37	4.126	3.388	<LDL
Jun/20/2017 07:17:51	4.114	3.380	<LDL
Jun/20/2017 07:00:05	4.142	3.400	<LDL
Jun/20/2017 06:42:19	4.179	3.406	<LDL
Jun/20/2017 06:24:33	4.197	3.432	<LDL
Jun/20/2017 06:06:47	4.211	3.435	<LDL
Jun/20/2017 05:49:01	4.244	3.444	0.068
Jun/20/2017 05:31:15	4.246	3.442	<LDL
Jun/20/2017 05:13:29	4.230	3.433	<LDL
Jun/20/2017 04:55:43	4.213	3.414	<LDL
Jun/20/2017 04:37:57	4.218	3.428	0.089
Jun/20/2017 04:20:11	4.229	3.453	<LDL
Jun/20/2017 04:02:25	4.222	3.447	<LDL
Jun/20/2017 03:44:39	4.203	3.444	<LDL

Component : C6H6

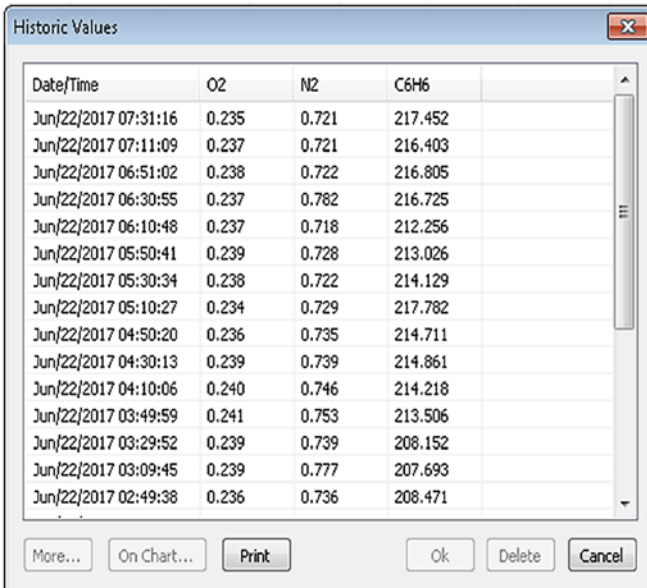

Historic Values window showing data for Component C6H6. The table contains 17 rows of data with columns for Date/Time, O2, N2, and C6H6. The O2 column values range from 0.233 to 0.239. The N2 column values range from 0.721 to 0.739. The C6H6 column values range from 208.471 to 217.452.

Date/Time	O2	N2	C6H6
Jun/22/2017 07:31:16	0.235	0.721	217.452
Jun/22/2017 07:11:09	0.237	0.721	216.403
Jun/22/2017 06:51:02	0.238	0.722	216.805
Jun/22/2017 06:30:55	0.237	0.782	216.725
Jun/22/2017 06:10:48	0.237	0.718	212.256
Jun/22/2017 05:50:41	0.239	0.728	213.026
Jun/22/2017 05:30:34	0.238	0.722	214.129
Jun/22/2017 05:10:27	0.234	0.729	217.782
Jun/22/2017 04:50:20	0.236	0.735	214.711
Jun/22/2017 04:30:13	0.239	0.739	214.861
Jun/22/2017 04:10:06	0.240	0.746	214.218
Jun/22/2017 03:49:59	0.241	0.753	213.506
Jun/22/2017 03:29:52	0.239	0.739	208.152
Jun/22/2017 03:09:45	0.239	0.777	207.693
Jun/22/2017 02:49:38	0.236	0.736	208.471

Component : H2S

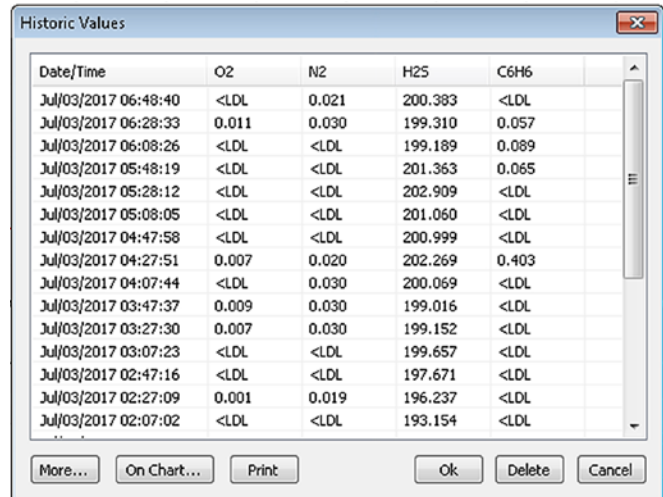

Historic Values window showing data for Component H2S. The table contains 17 rows of data with columns for Date/Time, O2, N2, H2S, and C6H6. The O2 column values range from 0.007 to 0.011. The N2 column values range from 0.020 to 0.030. The H2S column values range from 193.154 to 202.909. The C6H6 column values range from 0.057 to 0.089.

Date/Time	O2	N2	H2S	C6H6
Jul/03/2017 06:48:40	<LDL	0.021	200.383	<LDL
Jul/03/2017 06:28:33	0.011	0.030	199.310	0.057
Jul/03/2017 06:08:26	<LDL	<LDL	199.189	0.089
Jul/03/2017 05:48:19	<LDL	<LDL	201.363	0.065
Jul/03/2017 05:28:12	<LDL	<LDL	202.909	<LDL
Jul/03/2017 05:08:05	<LDL	<LDL	201.060	<LDL
Jul/03/2017 04:47:58	<LDL	<LDL	200.999	<LDL
Jul/03/2017 04:27:51	0.007	0.020	202.269	0.403
Jul/03/2017 04:07:44	<LDL	0.030	200.069	<LDL
Jul/03/2017 03:47:37	0.009	0.030	199.016	<LDL
Jul/03/2017 03:27:30	0.007	0.030	199.152	<LDL
Jul/03/2017 03:07:23	<LDL	<LDL	199.657	<LDL
Jul/03/2017 02:47:16	<LDL	<LDL	197.671	<LDL
Jul/03/2017 02:27:09	0.001	0.019	196.237	<LDL
Jul/03/2017 02:07:02	<LDL	<LDL	193.154	<LDL

CONCLUSION:

Our solution combining multiple LDetek instruments to achieve the complete carbon dioxide analysis all in one cabinet well demonstrated the capabilities to meet the food and beverage industry requirements. Have a look at our complementary application note LD16-012 that demonstrates other capabilities and results related to this market.

APPLICATION NOTE

LD23-02

Analysis of trace impurities in UHP Carbon Dioxide



▲ PlasmaDetek2
patent US 9,310,308 B2

▲ MultiDetek3

Carbon dioxide is commonly used as a raw material for production of various chemicals; as a working material in fire extinguishing systems; for carbonation of soft drinks; for freezing of food products such as poultry, meats, vegetables, and fruit; for chilling of meats prior to grinding; for refrigeration and maintenance of ideal atmospheric conditions during transportation of food products to market; for enhancement of oil recovery from oil wells; and for treatment of alkaline water.

The most common operations from which commercially produced carbon dioxide is recovered are industrial plants:

- Chemical plants (for ammonia and ethanol)
- Refineries
- Hydrogen production
- Fossil fuel power plants
- Industries such as iron and steel, cement, pulp and paper, etc.

Instead of being vented in environment during the production process, the CO₂ can be captured, purified and liquified and then be re-used to a huge diversity of applications from horticulture and welding to cryogenic cleaning and carbonated drinks. Carbon recycling not only contributes to climate and environmental protection, but it also has the added bonus of low supply costs and immediate availability of the gas. Alternatively, the CO₂ can be sequestered (in other words, stored underground) to mitigate the climate impact of industrial processes that rely on the combustion of fossil fuels.

LDETEK SOLUTION

The purity CO₂ solution proposed here with the MultiDetek3 gas chromatograph is for the analysis of trace impurities H₂S-COS-C₆H₆-SO₂-CO-CH₄-C₂+. The PED with Helium carrier gas has been configured for the ppb/ppm trace analysis of sulfurs, benzene, and carbon monoxide. An additional channel configured with an FID is used for the analysis of THC/VOCs

The MultiDetek3 CO₂ purity analysis system here has been configured with a range of 0-10ppm with Idl at 5-10ppb for sulfurs, benzene, and carbon monoxide with the PED. The FID channel used for THC/VOCs has been configured for 0-100ppm with Idl 25ppb. Other configurations are possible on request.

RESULTS

Chromatograms (Span calibration) of trace impurities H₂S-COS-C₆H₆-SO₂-CO-CH₄-THC in balance gas CO₂

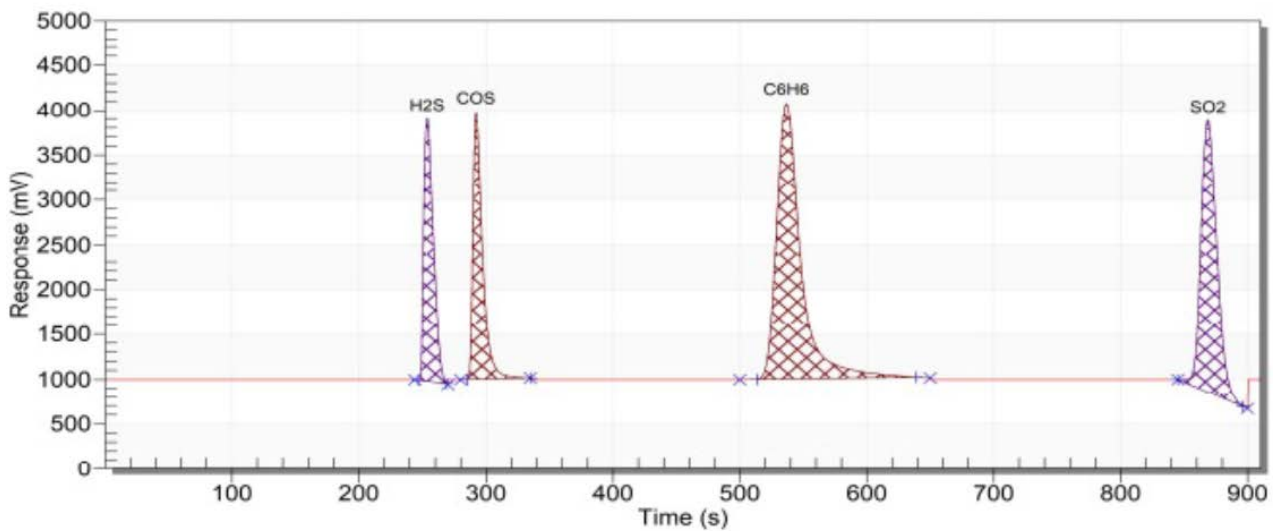

Peak	Unit	Calibration Value	_Area Counts
H ₂ S	ppm	10.000	25601
COS	ppm	8.280	25748
C ₆ H ₆	ppm	10.000	67624
SO ₂	ppm	10.200	44059

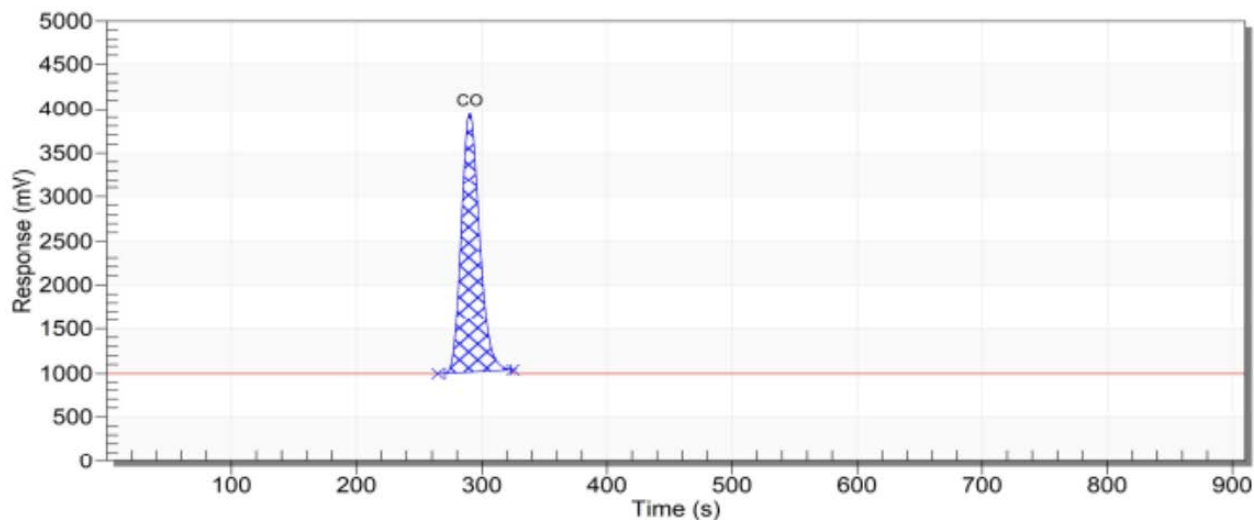

Peak	Unit	Calibration Value	_Area Counts
CO	ppm	107.000	49123

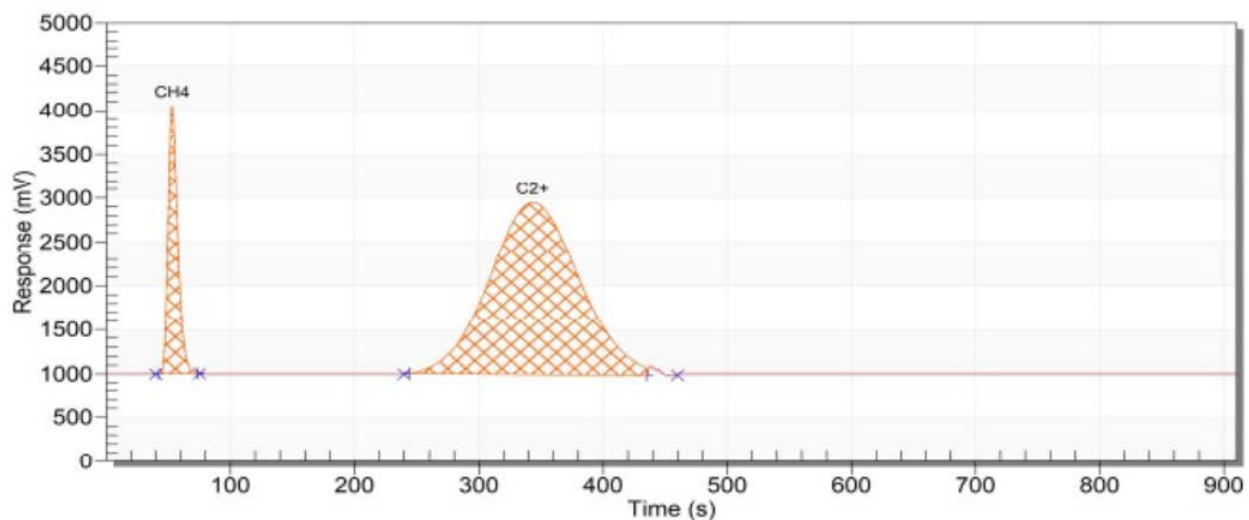

Peak	Unit	Calibration Value	_Area Counts
CH4	ppm	98.800	27413
C2+	ppm	100.000	159413

Limit of detection (based on 3 times the noise level from a blank)

COMPONENTS	CONCENTRATION (ppb)	PEAK HEIGHT	NOISE	LDL (3X NOISE)
H2S	9531	2918mV	0.58mV	6ppb
COS	9823	2978mV	0.36mV	4ppb
C6H6	7449	3652mV	0.77mV	5ppb
SO2	10191	3026mV	0.59mV	6ppb
CO	9531	2928mV	0.58mV	6ppb
CH4	98	20mV	0.42mV	6ppb
C2+ (THC/VOC)	510	16mV	0.26mV	25ppb

Note: other LDL could be obtained with different injection volume and chromatographic condition.

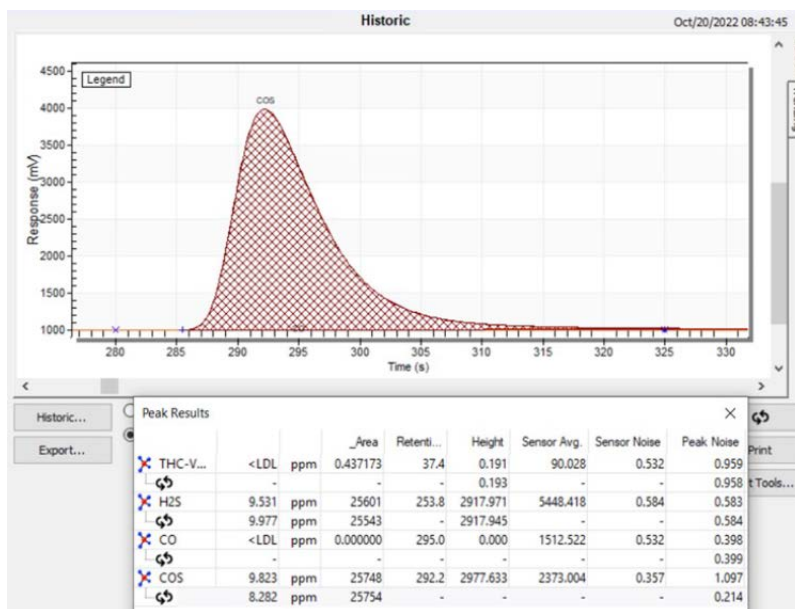
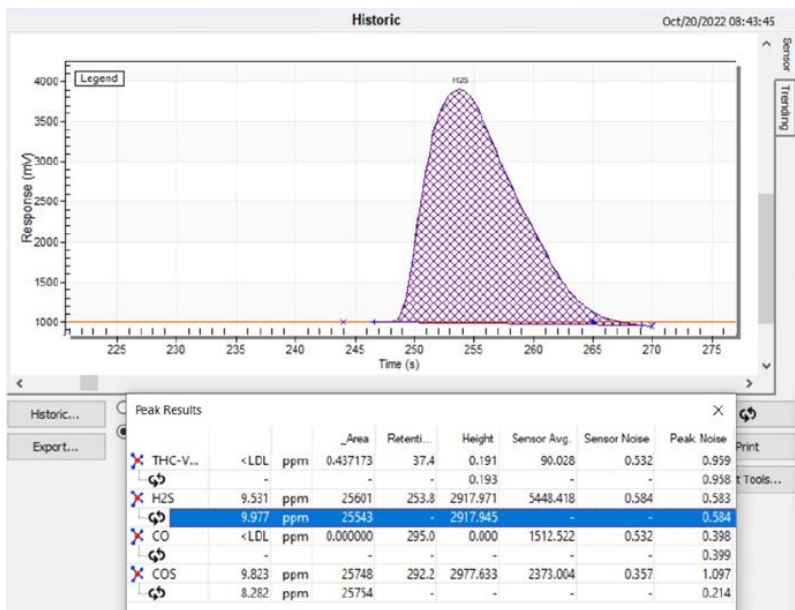

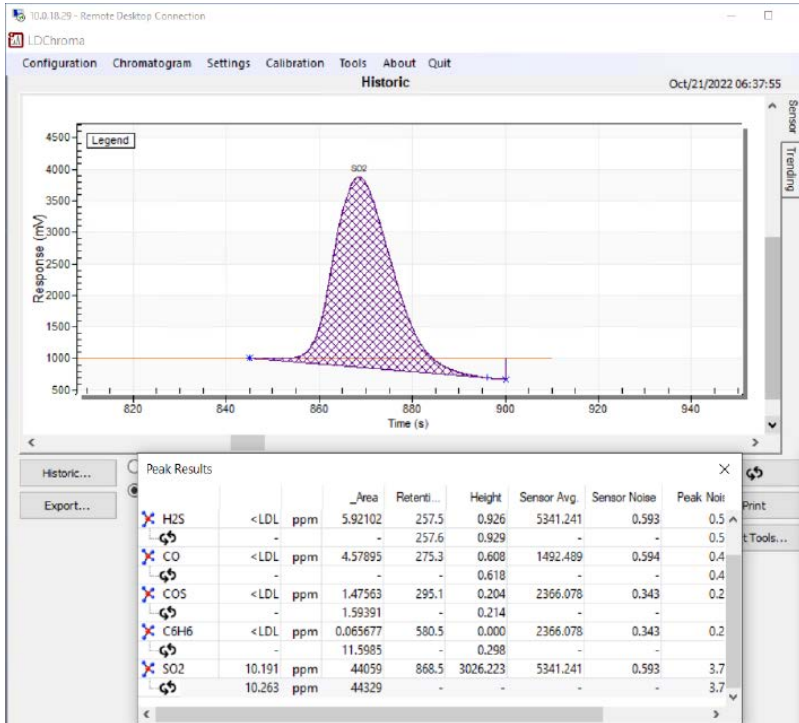
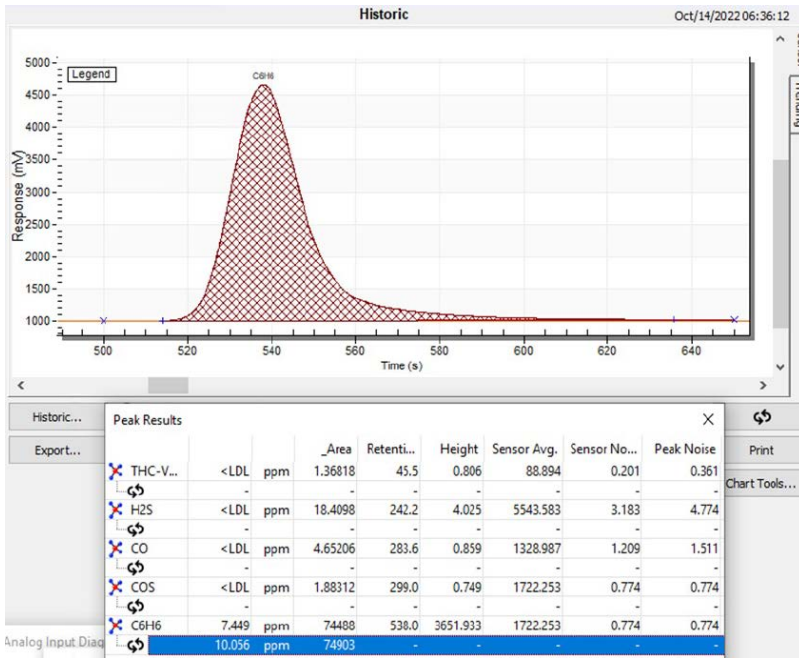

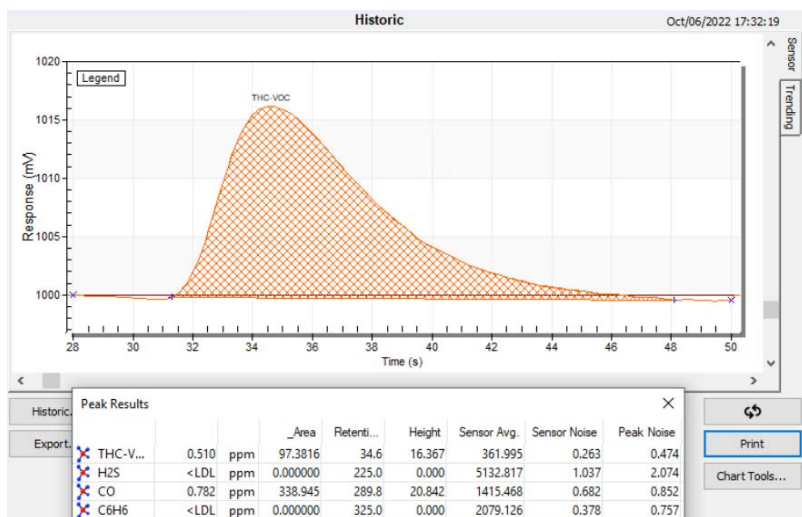
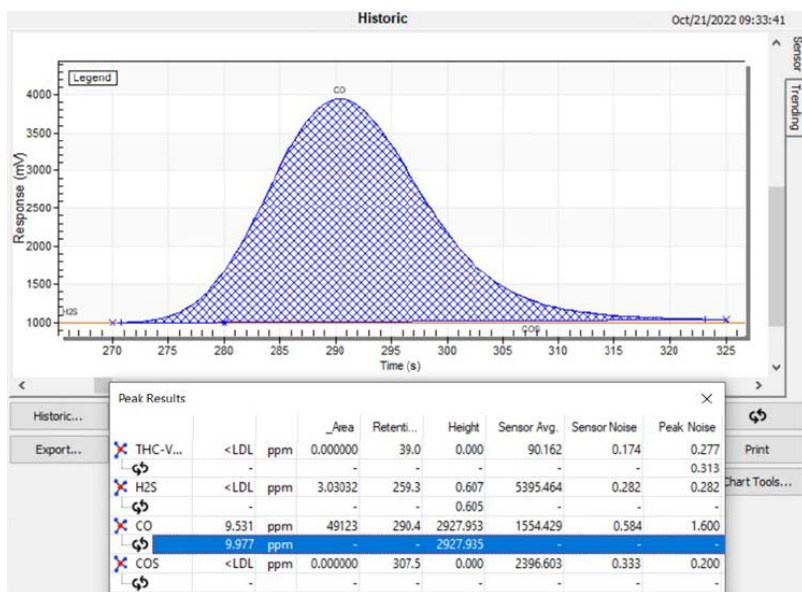

Repeatability: Based on the GC standards. Using 6 of 10 consecutive runs, being lower than 5% of $3 \cdot CV\%$

Linearity: Based on the GC standards. A linear curve having its R2 at a value between 0.998 and 1.00.

Accuracy: Based on the GC standards. $\leq 1\%$ of error or $|d|$ whichever is higher

CONCLUSION

The MultiDetek3 configured with PED and FID modules can offers a good analytical solution for trace ppb/ppm impurities for quality and validation of purity CO₂ required by the industry. The gas chromatograph is configured with standard industrial communication protocols and remote-control interface. The platform is modular to adapt any of additional requirement in terms of purity CO₂ production. The MultiDetek3 is a very robust gas analyzer configured for industrial market to run 24/7.



3.0 APPLICATION NOTE

3.9 PHARMACEUTICAL AND MEDICAL



3.0 APPLICATION NOTES

APPLICATION NOTE

LD20-01



MultiDetek2 gas chromatograph uses for medical & pharmaceutical applications



▲ MultiDetek2

LDETEK SOLUTION:

Our medical gas analysers control safety and quality of production, according to the European Pharmacopeia norms.

LDetek provides different GC configurations using the MultiDetek2 gas chromatograph where different detectors as our TCD and/or our FID can be mounted in.

Various applications possible :

- ▶ **Nitrogen:** Analysis of % N₂ by TCD (% O₂ optional)
- ▶ **Nitric Oxide:** Analysis of ppm N₂-CO₂-N₂ by TCD
- ▶ **Carbon dioxide:** Analysis of ppm CO by FID/methanizer
- ▶ **Nitrous Oxide:** Analysis of ppm CO by FID/methanizer & ppm CO₂ by TCD inside the same unit

RESULTS - NITROGEN ASSAY

Chromatogram of UHP Nitrogen

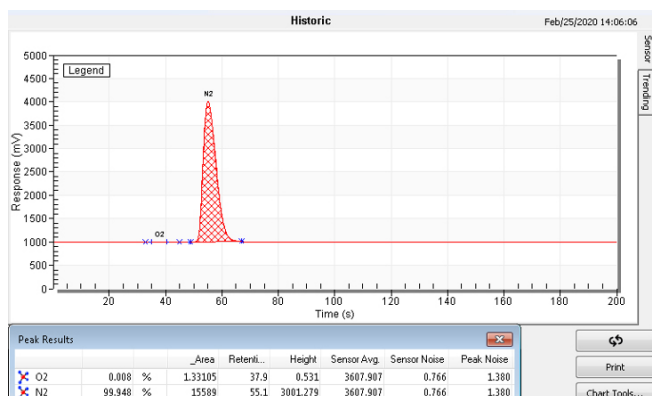

Chromatogram of a gas mixture containing 3% Oxygen & 97% Nitrogen

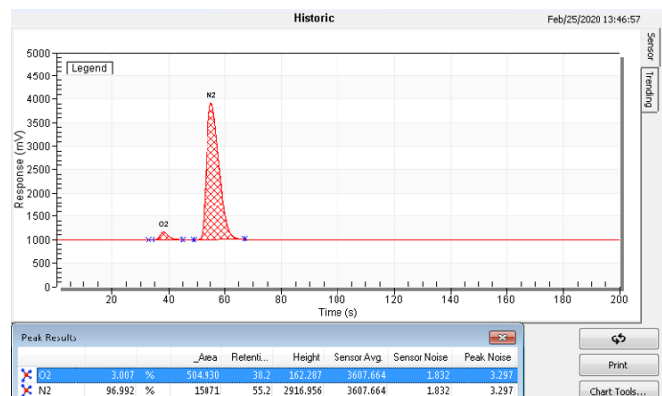

10 consecutive analyses to demonstrates a quick overview of the stability

Start	O2	N2
2020-02-21 11:47	3.007 %	97.024 %
2020-02-21 11:46	3.009 %	97.030 %
2020-02-21 11:44	3.004 %	97.038 %
2020-02-21 11:42	3.007 %	97.047 %
2020-02-21 11:40	3.008 %	97.045 %
2020-02-21 11:39	3.002 %	97.047 %
2020-02-21 11:37	3.004 %	97.031 %
2020-02-21 11:35	3.008 %	97.034 %
2020-02-21 11:33	3.008 %	97.033 %
2020-02-21 11:32	3.007 %	97.021 %
2020-02-21 11:30	3.015 %	97.000 %

RESULTS - NITRIC OXIDE ASSAY

Chromatogram of a gas mixture containing 3000ppm N2-CO2-N2O in a balance of Nitric Oxide.

Chromatogram of a gas mixture containing 1500ppm N2-CO2-N2O in a balance of Nitric Oxide. Considering a ratio of 3 times the noise level, the LDLs for the N2-CO2-N2O have been established at 10ppm.

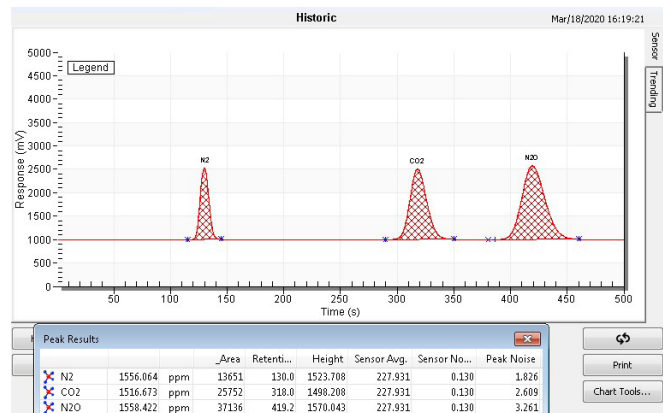
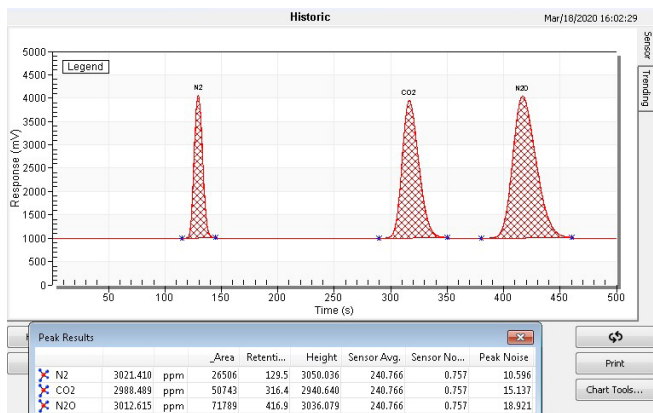

RESULTS - CARBON DIOXIDE ASSAY

Chromatogram of a gas mixture containing 5ppm CO in a balance of Carbon dioxide.

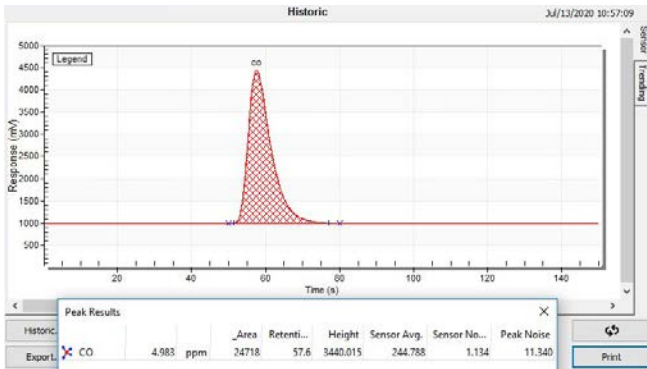

Chromatogram of a gas mixture containing 1ppm CO in a balance of Carbon dioxide.

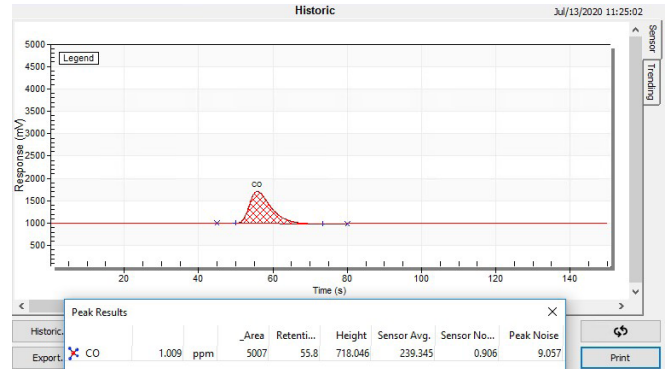

Chromatogram of a gas mixture containing 0.1ppm CO in a balance of Carbon dioxide. Considering a ratio of 3 times the noise level, the LDL for the CO has been established at 25ppb.

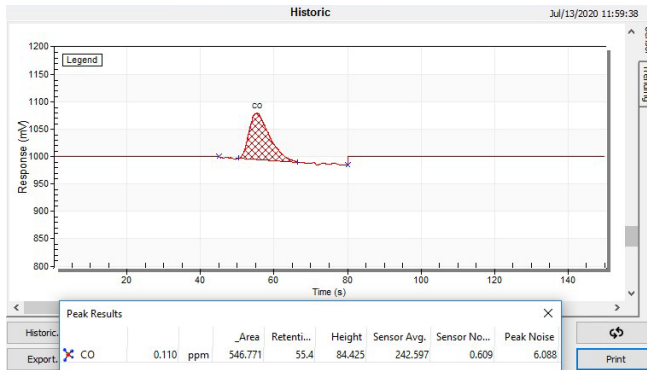

Repeatability Test: 10 Cycles @ 1.2ppm CO in CO2 balance

Peak	Average	Standard Deviation	Coefficient of Variation (%)	3 * CV (%)	Status
CO	1.21985583 ppm	0.00428070	0.35	1.05	Accepted

Start	CO
2020-07-13 16:28	1.227 ppm
2020-07-13 16:25	1.220 ppm
2020-07-13 16:22	1.216 ppm
2020-07-13 16:20	1.213 ppm
2020-07-13 16:17	1.216 ppm
2020-07-13 16:15	1.219 ppm
2020-07-13 16:12	1.222 ppm
2020-07-13 16:10	1.225 ppm
2020-07-13 16:07	1.222 ppm
2020-07-13 16:04	1.219 ppm

RESULTS - NITROUS OXIDE ASSAY

Chromatogram of a gas mixture containing 1ppm CO on FID/methanizer channel and 100ppm CO2 on TCD channel in a balance of Nitrous oxide. Considering a ratio of 3 times the noise level, the LDL for the CO has been established at 25ppb and it has been established at 10ppm for the CO2.

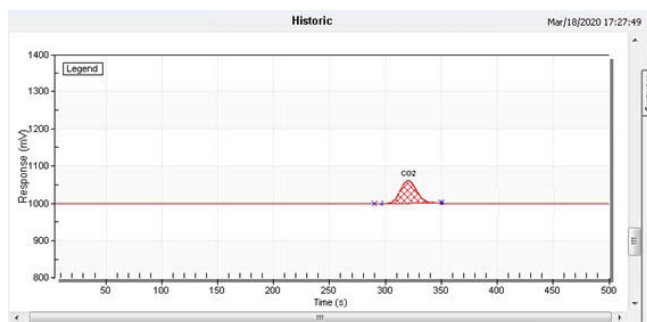
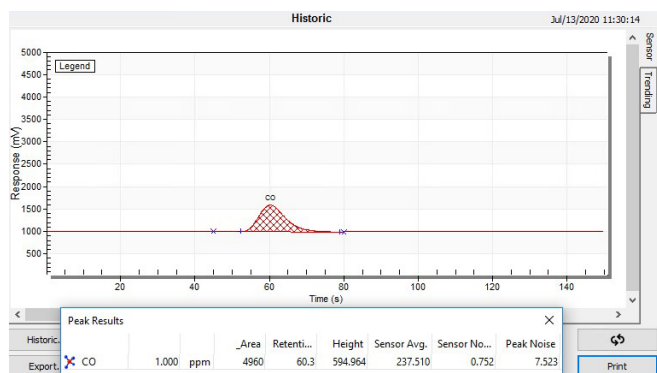

CONCLUSION:

With its combination of the TCD and the FID, the MultiDetek2 can be configured adequately for the European pharmacopeia norms. Our system is compact and offer the performances required by this medical market. The platform offers a touchscreen panel PC with date storage disk and remote-control platform.



3.0 APPLICATION NOTE

3.10 ELECTRONIC SPECIAL GASES



3.0 APPLICATION NOTES

APPLICATION NOTE

LD20-02



MultiDetek2 gas chromatograph with PlasmaDetek2 detector uses for hydrogen isotopes separation and the analysis of impurities in Deuterium



▲ MultiDetek2

▲ PlasmaDetek2

LDETEK SOLUTION:

The complex analysis of the impurities in a sample gas containing high purity deuterium (D₂) can be realized with our gas chromatograph model MultiDetek2. The detector uses for the trace impurities is the PlasmaDetek2, which is configured with its selective optics to obtain the best selectivity and sensitivity to the required impurities to be measured. The requirements here was a range of 10ppm and 100ppm capable of detecting down to 10ppb limit of detection for each impurity. The GC has been coupled with our cryo system to realize the separation of the hydrogen isotopes without interference in a relative short analysis time.

Sample composition of deuterium (D₂):

IMPURITIES	RANGE	SYSTEM LDL	SYSTEM LOQ
O ₂	0-10 ppm	10 ppb	50 ppb
CH ₄	0-10 ppm	10 ppb	50 ppb
N ₂	0-10 ppm	10 ppb	50 ppb
CO	0-10 ppm	10 ppb	50 ppb
CO ₂	0-10 ppm	10 ppb	50 ppb
NMHC	0-10 ppm	10 ppb	50 ppb
H ₂	0-10 ppm	10 ppb	50 ppb
HD	0-100 ppm	10 ppb	50 ppb
D ₂	100 %	--	--

RESULTS

Chromatogram of trace ppm impurities O₂-CH₄-N₂-CO-CO₂-NMHC-H₂ in pure D₂ (deuterium)

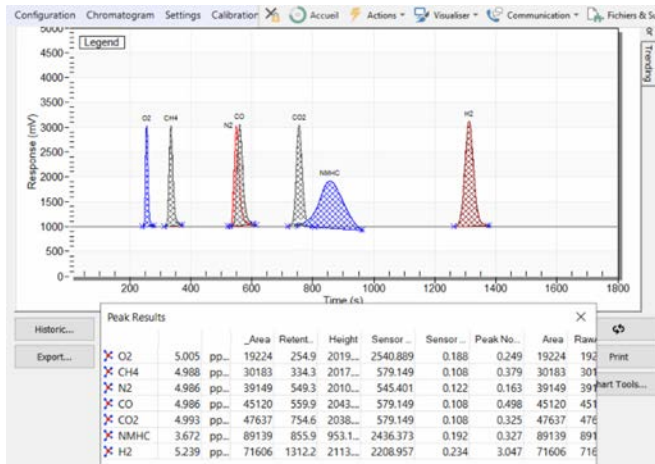

Chromatogram of trace ppm impurity HD (hydrogen deuteride) in pure D₂ (deuterium)

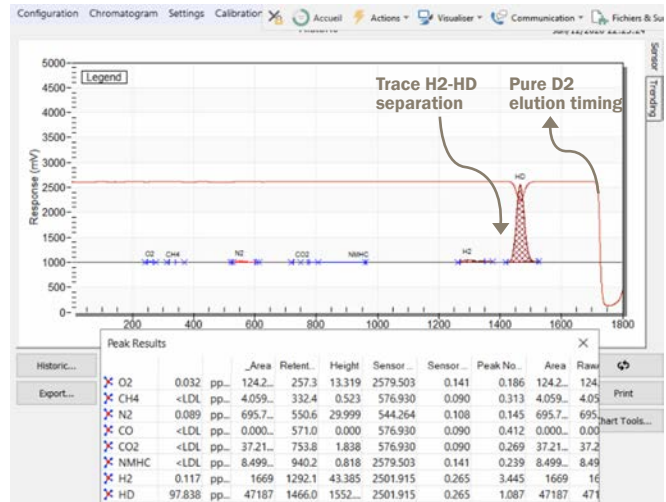

This chromatogram shows the good separation of the hydrogen isotopes H₂-HD-D₂ by using our PED detector combines with our MultiDetek2 cryo system.

COMPONENT	CONCENTRATION	PEAK HEIGHT	NOISE	LDL (3X NOISE)
O ₂	5.005 ppm	2019 mV	1.3 mV	9.66 ppb
CH ₄	4.988 ppm	2017 mV	1.2 mV	8.90 ppb
N ₂	4.986 ppm	2010 mV	0.9 mV	6.69 ppb
CO	4.986 ppm	2043 mV	1.5 mV	10.9 ppb
CO ₂	4.993 ppm	2038 mV	1.4 mV	10.2 ppb
NMHC	3.672 ppm	953 mV	0.9 mV	10.4 ppb
H ₂	5.239 ppm	2113 mV	1.2 mV	8.92 ppb
HD	97.838 ppm	1552 mV	0.07 mV	13.2 ppb

Note: other LDL could be obtained with different injection volume and chromatographic condition

CONCLUSION:

The MultiDetek2 gas chromatograph uses with the PlasmaDetek2 detector and the LDetek cryo column cooling system all in one unit can measured trace impurities in deuterium. The system is capable to achieve a full ppm range with 10ppb limit of detection. The separation of the hydrogen isotopes is easily realized by maintaining the micro packed column in a cryogenic environment. The system is rackmount and compact offering a full remote control. The industrial communication protocols are all built in and must simply be selected specifically for your requirements.

APPLICATION NOTE

LD20-05



MultiDetek2 gas chromatograph with PlasmaDetek2 & TCD detectors uses for the analysis of purity Xenon-Krypton-Neon



▲ MultiDetek2

▲ PlasmaDetek2

The noble gases also called inert gases or rare gases have several characteristics that make them important and unique as: low reactivity, low thermal conductivity and high stability, among others. Being at very low concentration in the earth's atmosphere, it makes these gases very expensive to produce. The six naturally noble gases are Helium (He), Neon (Ne), Argon (Ar), Krypton (Kr), Xenon (Xe) and the radioactive Radon (Rn).

The rarest gases of these are Xenon, Krypton and Neon making them very expensive to use for industrial applications.

NEON/KRYPTON/XENON MAJOR APPLICATIONS:

Aerospace: Xenon is used for the following aerospace applications: satellite programs, space travel, propulsion agent for spacecraft, satellite thruster and interplanetary probe.

Electronics: These rare gases, can be used in many electronics applications such as: excimer lasers, buffer gas used in lasers for semiconductor manufacturing, deep trench etching of DRAM integrated circuits, focused etch process, and plasma panel display.

Glass: Krypton is used as a filler in the production of double and triple-pane insulated windows. Major advantages of using krypton are reducing heat loss, increasing heat transfer resistance in the unit, and reducing levels of solar radiation. You can also increase the R-value or decrease the U-factor for window and door insulation with krypton, xenon and rare gas mixtures.

Lasers: Neon-based excimer lasers are utilized for etching silicon wafers, LASIK eye surgery, micro-machining organic materials, UV lithography in integrated circuit fabrication, micro drilling, He/Ne mixes for optical readers, and wafer dicing. Krypton gas lasers are also used during scientific research, to create white-light lasers and light shows.

Lighting: Krypton is used for bright white light and long lasting incandescent bulbs, as well as photographic lighting applications. Neon is used for lighting in signs. Stadiums, automotive HID, head lights, IMAX theaters, photography and other concentrated, bright-light applications rely on xenon to for their lighting needs.

LDETEK SOLUTION:

Measuring the purity of UHP Xenon, Krypton and Neon can be done with the MultiDetek2 analytical device. A combination of multiple columns, diaphragm valves and detectors all in one instrument are used to measure many different impurities to validate the purity of these UHP gases.

Our system uses the PlasmaDetek2 (PED) as detector to ensure good selectivity and sensitivity down to sub ppb level. The proper optic circuits are mounted on each of the PED installed in the instrument to optimize the selectivity for the impurity to analyse. Helium carrier gas is used here to ensure a limit of detection below 10ppb.

In the same instrument, our thermal conductivity detector (TCD) is mounted to measure the Helium impurity down to 1ppm concentration. The Argon carrier gas is required here to achieve the limit of detection.

This application note will show the results of three different configurations of the MultiDetek2 instrument used for respectively measuring the purity of Xenon, Krypton and Neon. Different chromatograms show the response of every impurity to be analysed. The peak response obtained at a known concentration is then compared to the blank noise level to determinate the limit of detection obtained by our instruments.

RESULTS FOR XENON GC:

Chromatograms of trace ppm impurities H₂-O₂-CO-CO₂-Ar-C₂F₆-CF₄-CH₄-Kr-N₂-N₂O-SF₆ in UHP Xenon sample gas.

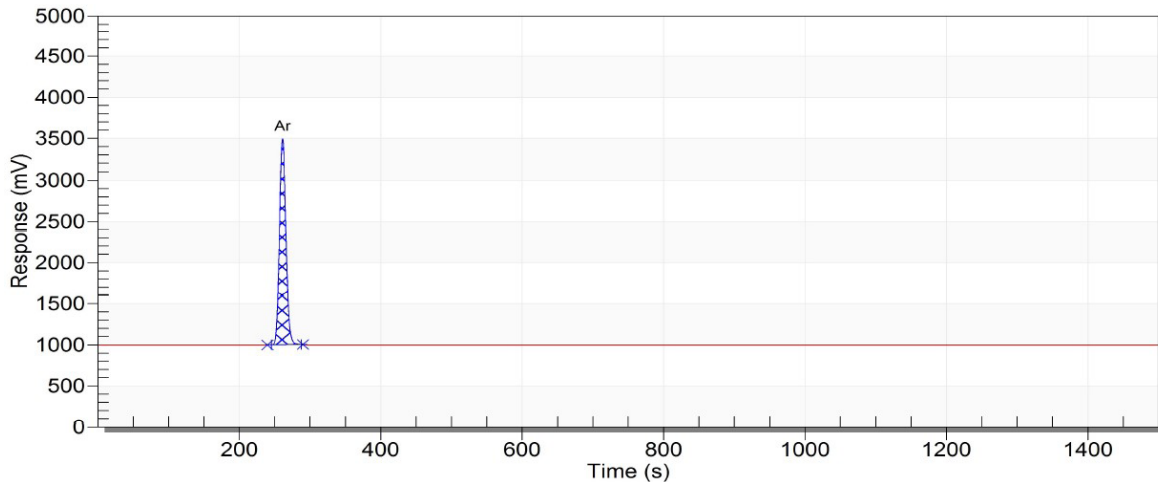
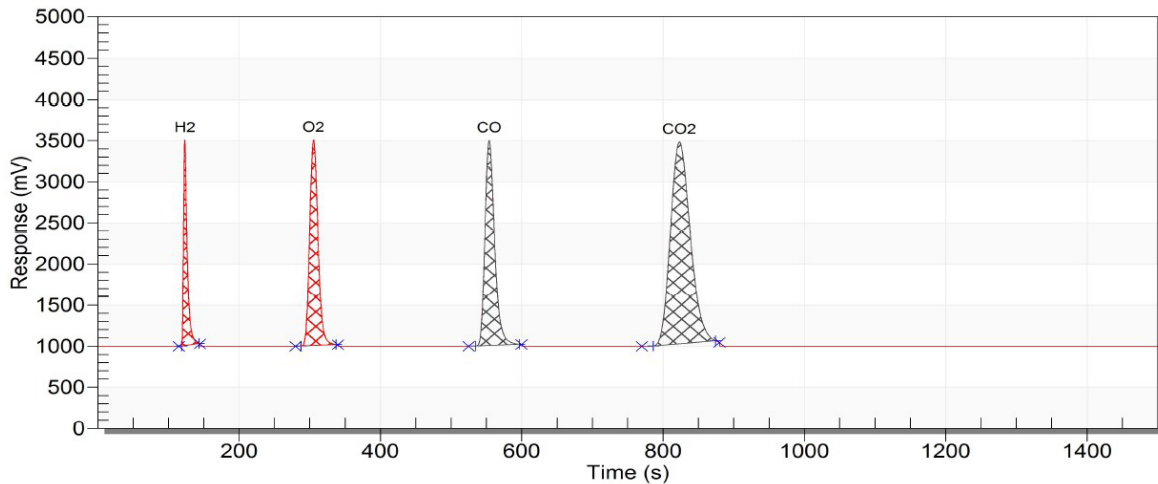

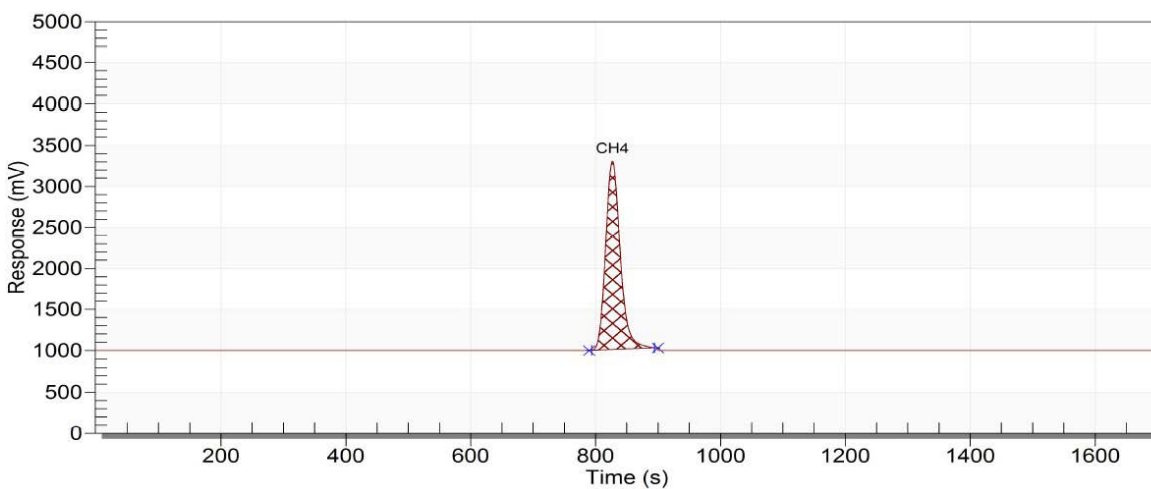
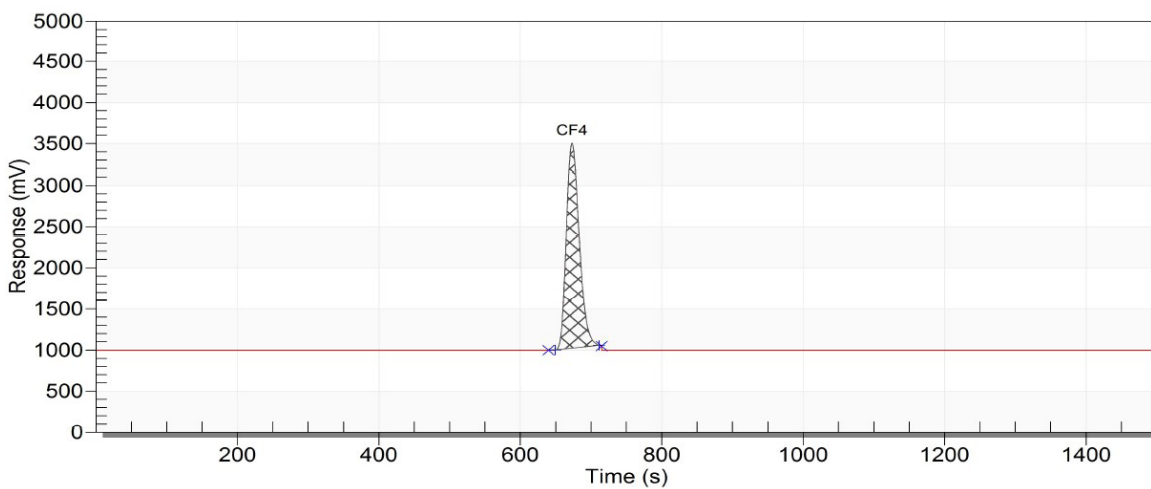
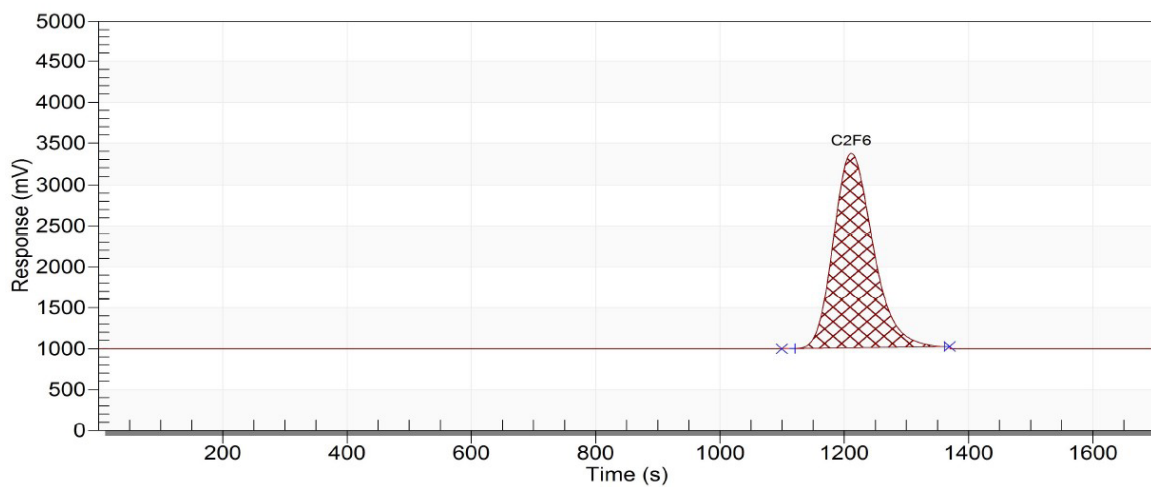

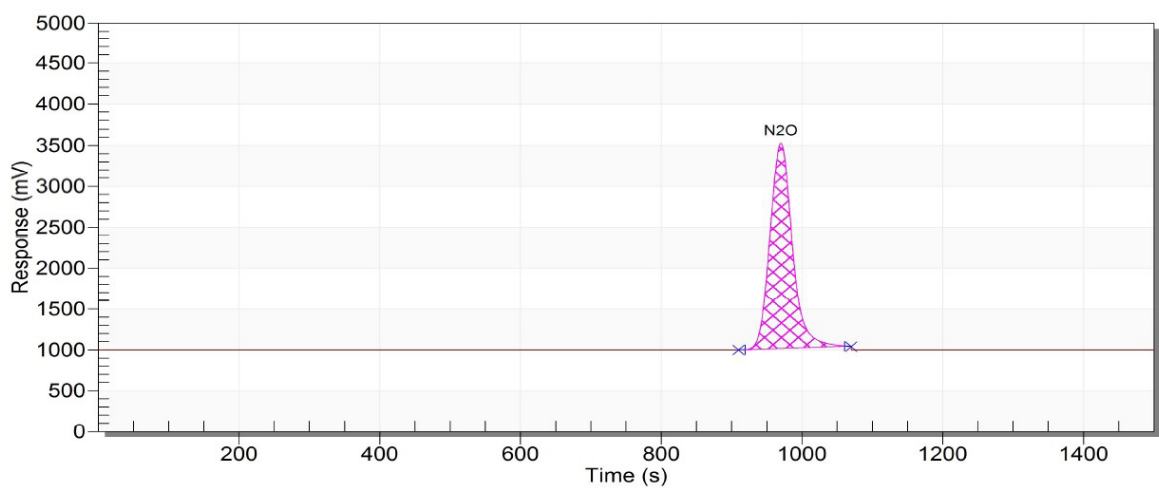
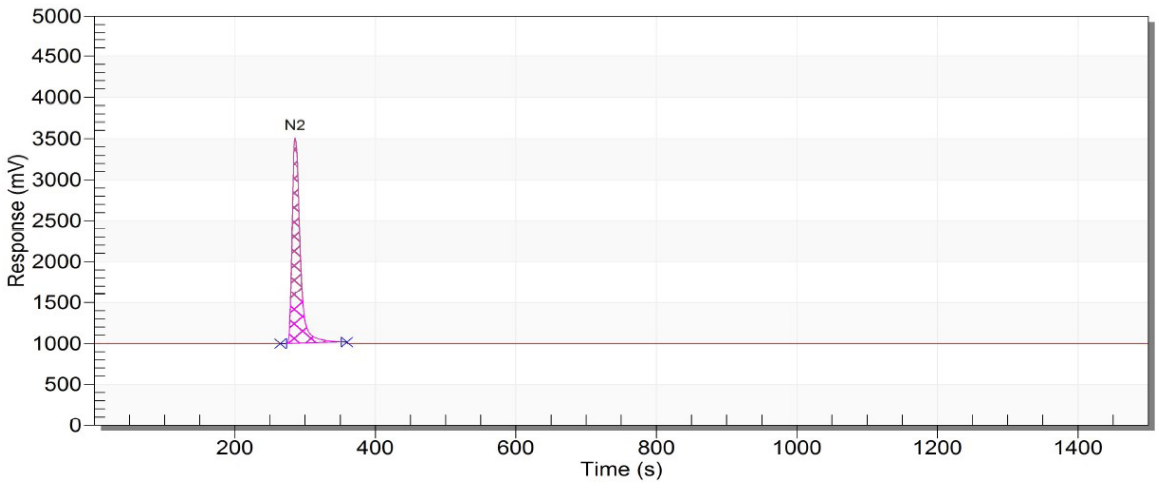
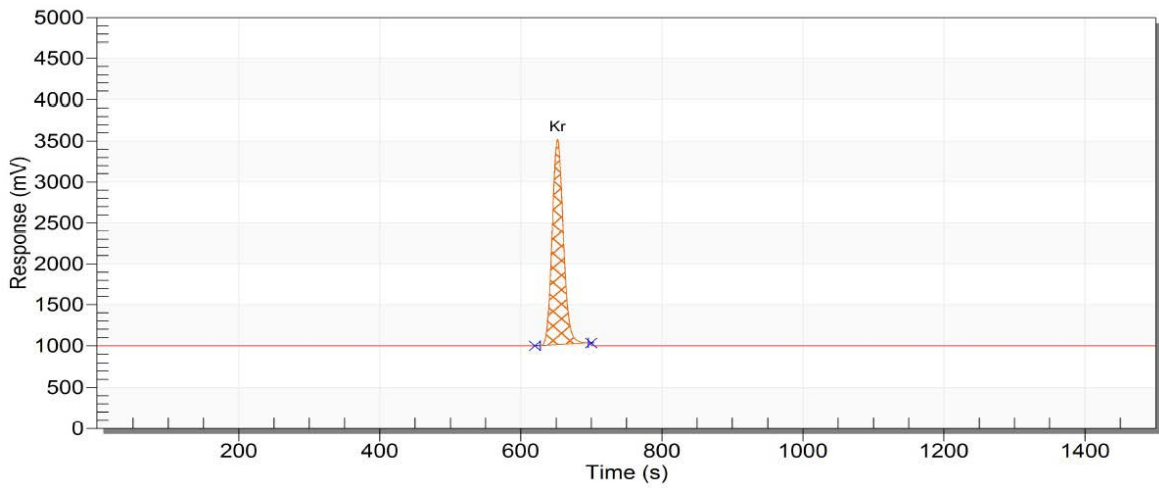

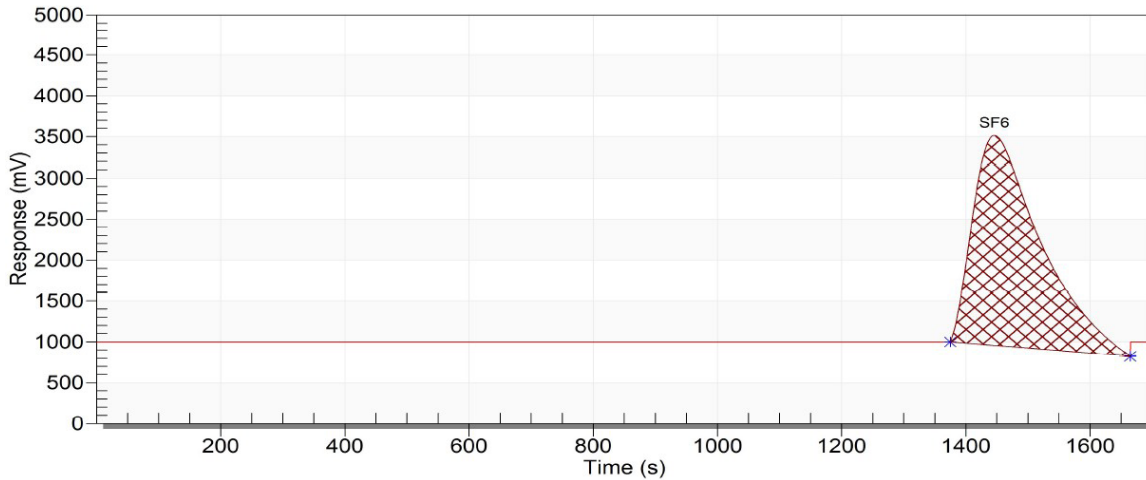

Sample composition of Xenon and determination of the limit of detection:

COMPONENT	CONCENTRATION (ppm)	PEAK HEIGHT (mV)	NOISE (mV)	LDL (3X NOISE) (ppb)
H2	11.00	2502	0.48	6.3
O2	11.00	2499	0.51	6.7
CO	11.00	2498	0.55	7.2
CO2	11.00	2487	0.55	7.3
Ar	8.90	2504	0.46	4.9
C2F6	10.00	2402	0.56	6.9
CF4	10.00	2382	0.56	7.0
CH4	10.00	2504	0.50	5.9
Kr	10.00	2506	0.54	6.5
N2	10.00	2504	0.45	5.4
N2O	10.00	2501	0.45	5.4
SF6	10.00	2500	0.70	8.4

Figure 1

Note: other LDL could be obtained with different injection volume and chromatographic condition

RESULTS FOR KRYPTON GC:

Chromatograms of trace ppm impurities Ar-CO₂-CF₄-H₂-O₂-N₂-CH₄-CO-Xe in UHP Krypton sample gas

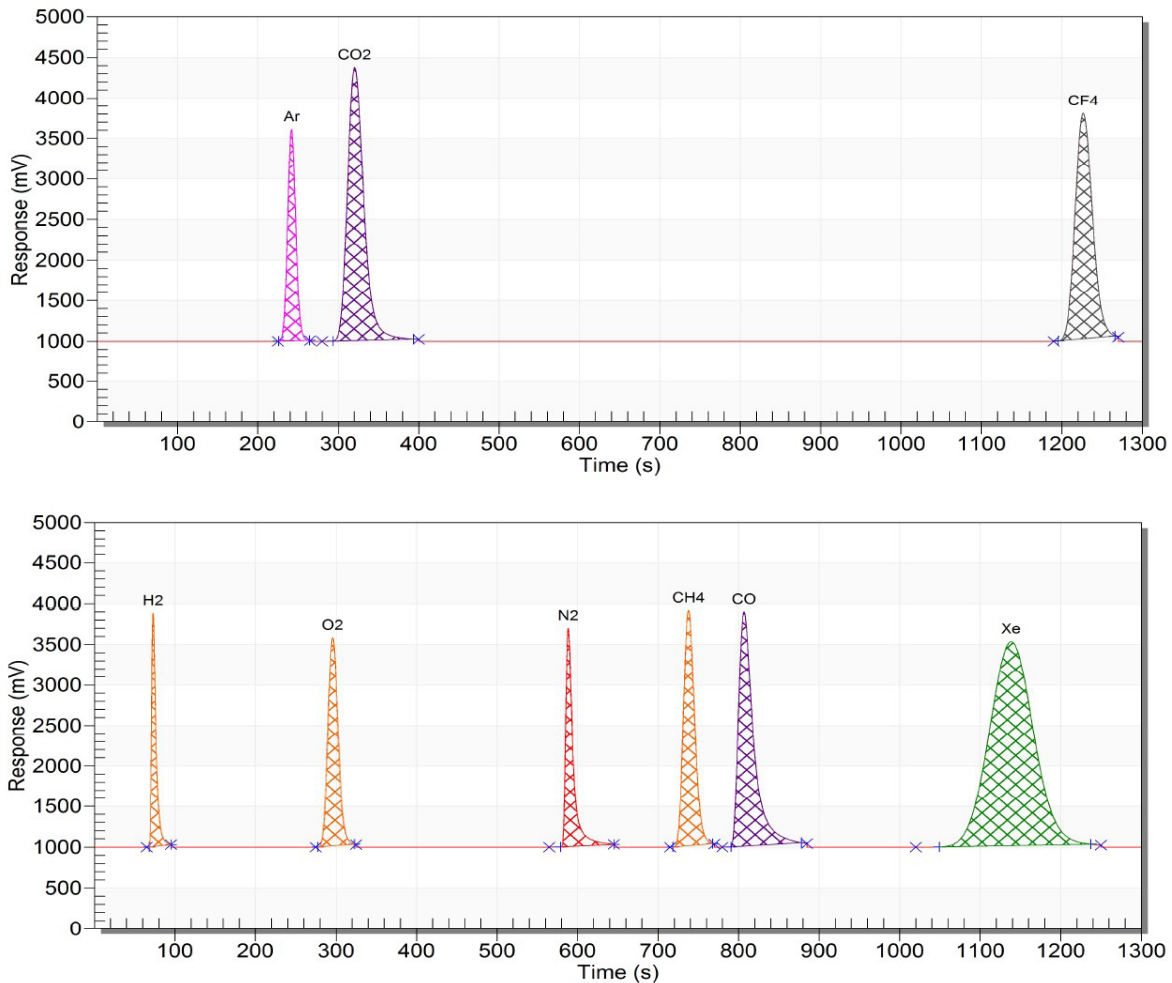

Sample composition of Krypton and determination of the limit of detection:

COMPONENT	CONCENTRATION (ppm)	PEAK HEIGHT (mV)	NOISE (mV)	LDL (3X NOISE) (ppb)
Ar	8.90	2606	0.46	4.7
CO ₂	10.10	3377	0.55	4.9
CF ₄	10.00	2802	0.56	6.0
H ₂	9.50	2981	0.49	4.7
O ₂	8.50	2599	0.51	5.0
N ₂	9.10	2750	0.46	4.6
CH ₄	9.80	2955	0.52	5.2
CO	9.50	2952	0.55	5.3
Xe	10.00	2523	0.60	7.1

Figure 2 Note: other LDL could be obtained with different injection volume and chromatographic condition

RESULTS FOR NEON GC:

Chromatograms of trace ppm impurities O₂-Ar-N₂-CH₄-CO₂-CO-H₂-He in UHP Neon sample gas

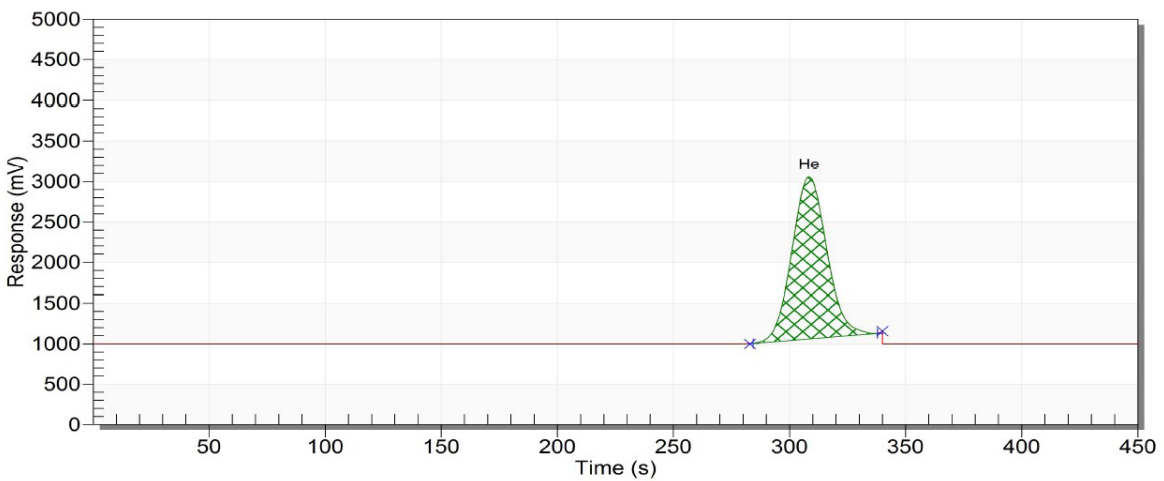
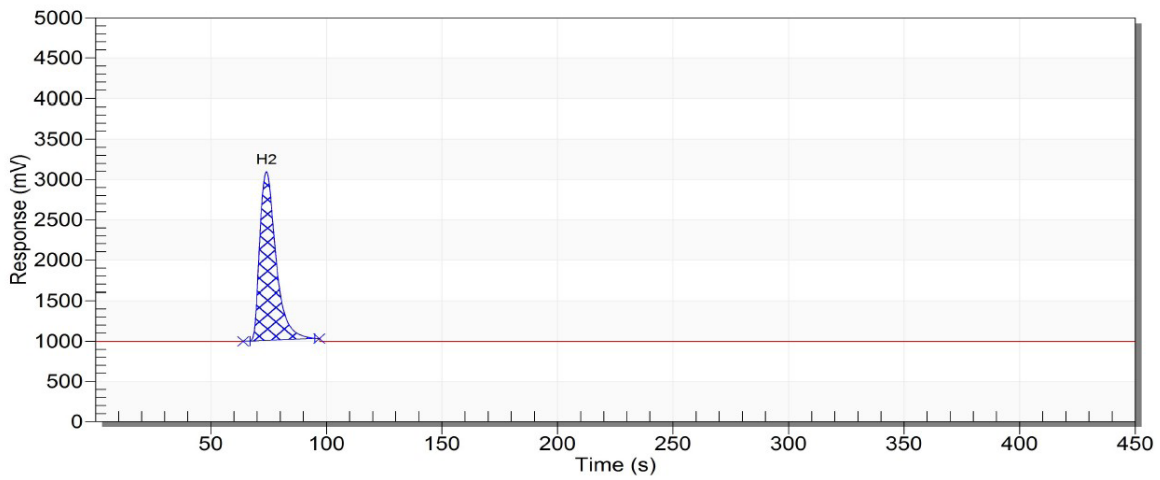
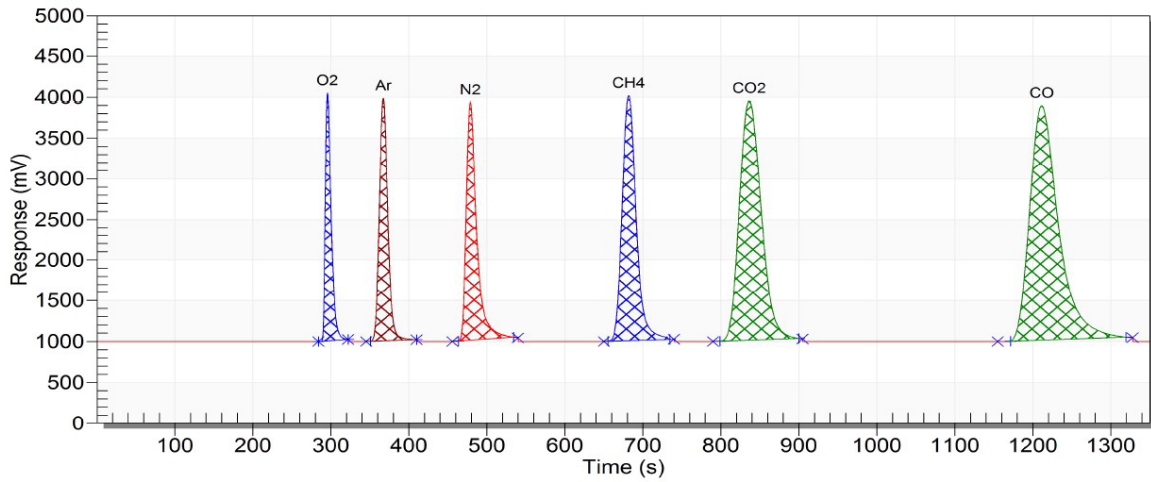

Sample composition of Neon and determination of the limit of detection:

COMPONENT	CONCENTRATION (ppm)	PEAK HEIGHT (mV)	NOISE (mV)	LDL (3X NOISE) (ppb)
O2	53.30	3098	0.21	10.8
Ar	50.00	3005	0.17	8.4
N2	49.50	2967	0.20	10.0
CH4	48.30	3021	0.25	12.0
CO2	44.80	2991	0.31	13.9
CO	48.20	2901	0.31	15.5
H2	50.00	2101	0.14	10.0
He (TCD)	50.00	2109	15	1066 (1.06ppm)

Figure 3

Note: other LDL could be obtained with different injection volume and chromatographic condition

CONCLUSION:

The MultiDetek2 gas chromatograph uses with the PlasmaDetek2 and the thermal conductivity detector (TCD) together in the same instrument allows to measure multiple impurities in sub ppb along with detecting He impurity down to 1ppm concentration. The system is rackmount and compact. It also offers a full remote control and the proper industrial communication protocol.

APPLICATION NOTE

LD21-03



Analysis of trace impurities in UHP B2H6 used for semiconductor industry with the PlasmaDetek2 and MultiDetek2 GC

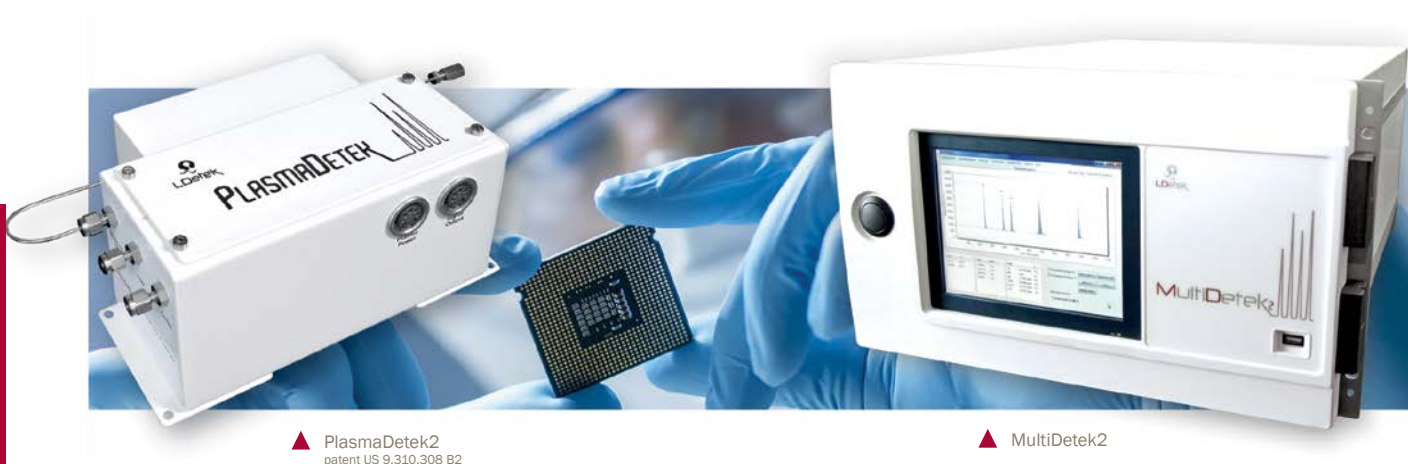

▲ PlasmaDetek2
patent US 9,310,308 B2

▲ MultiDetek2

Measuring trace impurities down to sub ppb is required by the semiconductor industry for UHP Diborane (B₂H₆). This very reactive gas is used in the electronics and photovoltaic industries as a semi-conductor doping agent.

LDETEK SOLUTION

The MultiDetek2 gas chromatograph is configured with one channel for the light impurities and another channel for the heavier impurities to measure. Both channels used a PED with Helium as carrier gas source.

Working here with the very reactive sample gas B₂H₆, which is also well known to generate weak acids, the separation columns and the detectors mounted in each channel are individually protected with a pre-column mounted in a backflush to vent configuration. The protection columns and the backflush/injection diaphragm valves are constructed with Hastelloy to be compatible with the aggressivity of the sample gas.

On top of that, the MultiDetek2 is equipped with an integrated stream selector system also constructed with Hastelloy material. The stream selector system allows to switch from stream B₂H₆ along to Span gas for calibration/validation purpose. An extra inlet has been added to the stream selector system to switch the sample gas between each analysis to an inert gas being helium in this case. This feature is used to protect the injection valves and sampling loops from the aggressivity of the sample gas. By this type of configuration, we keep the corrosion and degradation of the flow path away.

RESULTS

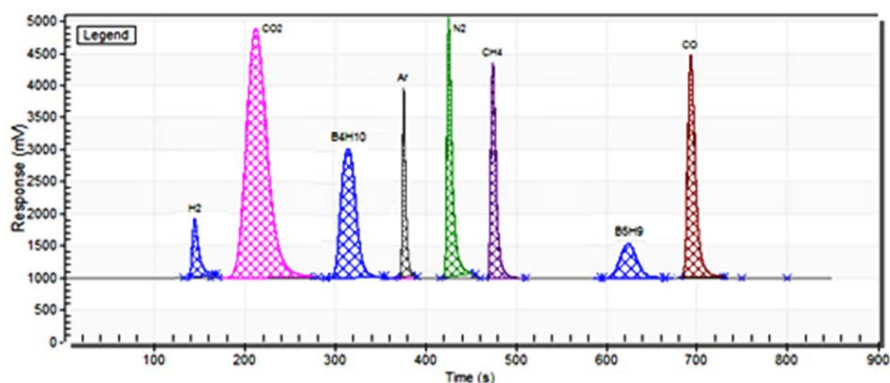

Chromatogram:
Trace H₂-CO₂-B₄H₁₀-Ar-N₂-CH₄-
B₅H₉-CO-B₅H₁₁ impurities in
Diborane (B₂H₆)

Limit of detection (based on 3 times the noise level from a blank)

COMPONENTS	CONCENTRATION (ppm)	PEAK HEIGHT	NOISE	LDL (3X NOISE)
H ₂	5.8	975mV	0.2mV	3.5ppb
CO ₂	6.6	3880mV	0.2mV	1.0ppb
B ₄ H ₁₀	10.8	2007mV	0.2mV	3.2ppb
Ar	4.9	2989mV	0.1mV	0.5ppb
N ₂	12.9	4000mV	0.1mV	1.0ppb
CH ₄	5.8	3344mV	0.2mV	1.0ppb
B ₅ H ₉	5.9	523mV	0.2mV	6.7ppb
CO	5.1	3503mV	0.2mV	0.9ppb
B ₅ H ₁₁	n/a	n/a	0.2mV	5-10ppb

Note: other LDL could be obtained with different injection volume and chromatographic condition

CONCLUSION

Using the PlasmaDetek2 detector inside one-unit MultiDetek2 GC, the analysis of trace ppb/ppm impurities H₂-CO₂-B₄H₁₀-Ar-N₂-CH₄-B₅H₉-CO-B₅H₁₁ impurities in Diborane (B₂H₆) can be performed. The analysis time is less than 15 minutes. The unit was configured with a combination of Hastelloy and coated stainless steel valves/fittings/columns and tubing to be compatible with the aggressive and acid nature of the sample gas. Using the proper material, the system is robust and safe to operate for years. The unit uses 4-20mA outputs for each impurity and also the Modbus protocol for data transmission. Our LDGSS stream selector system has been used as well to allow switching across the different streams. The LDGSS also has been configured with Hastelloy material to be compatible with the aggressivity of the sample gas.



3.0 APPLICATION NOTE

3.11 DESIGN REPORTS



3.0 APPLICATION NOTES



LD8000



TRACE NITROGEN IN ARGON OR HELIUM ANALYZER

DESIGN REPORT v2



3.0 APPLICATION NOTES



The need of trace nitrogen in argon or helium analysis in the industry is not something new. Many instruments have been and still are on the market to achieve such measurement for different type of applications. The most popular use is without any doubt in air separation industry for the production of argon.

The demand and the production of gas more and more pure require good analytical instrumentations. It is even more the case for the measurement of nitrogen. Small leakage, dead volume, change in temperature, bad accuracy, etc can all cause big headaches.

In this document, information about the design of the LDetek LD8000 trace nitrogen in argon or helium analyzer will be described to explain how we achieve such good performance. Those results are also described to show that the LD8000 is now the solution for any applications that require such measurement.

ANALYZER COMPONENTS

PLASMA EMISSION DETECTOR (PED):

Detection principle

The LD8000 is using a Plasma Emission Detector where the principle is based on a spectroscopic emission cell. This is actually not a new technique, but the unique design of LDetek in terms of frequency, intensity as well as the mechanical and electrodes conception make the system very stable and efficient.

A luminous phenomenon, called electroluminescence, is created and is used as emission technique to quantify the nitrogen analyte. A plasma is created with the argon or helium flowing in the cell and when concentration of nitrogen changes, spectral lines emission change as well. The light is then directed in an optical filter that will discriminate the spectral lines. At the end, a photo-diode will convert light to current to make a proportional electric signal of nitrogen in the sample.

With its unique design, LDetek achieves unsurpassed performance that provides now a reference trace nitrogen in argon or helium analyzer.

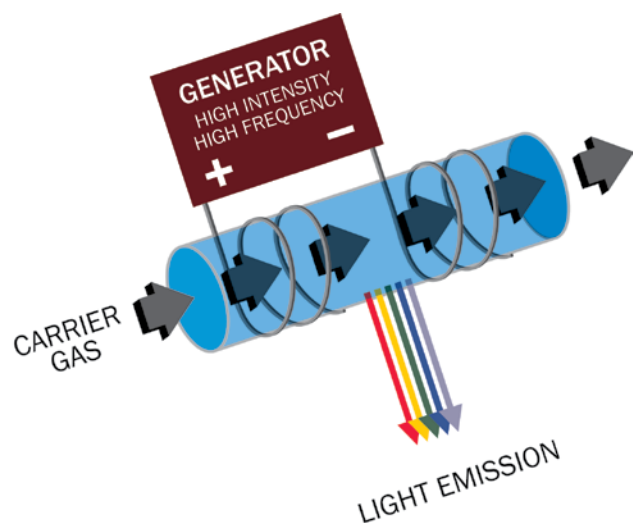

Figure 1: Plasma detector principle

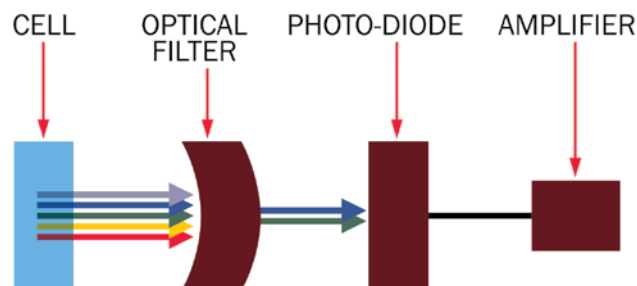

Figure 2: Light to current transformation

Plasma Cell

The cell of the PED is generally made of quartz. The material used has strong UV transmission properties. It is also durable, inert and heat resistant.

LDetek plasma detector has a specific cell design that provides a stable plasma. This unique conception will help getting low noise and good sensitivity when nitrogen is flowing in the detector along with the argon or helium. The wall cell design made of quartz combined with specific electrodes shape and inlet/outlet flow path configuration are some of the key parameters that give the performance of a PED.

Plasma Generator

The plasma generator is also quite important. Its specific voltage, frequency and current make the glow discharge in the cell very stable. The combination of the cell design and generator is critical in such application. LDetek has developed a perfect combination to get a stable light emission from the plasma. The components of the generator are well proven to be efficient and resistant over the years.

The generator is also based on a duty cycle controlled system that extends lifetime of the cell. The cell is put ON and OFF on a specific frequency and period to help the system to give the performance desired as well as decreasing the degradation of the detector.

Optical Filter and photo-diode

Optical filter is made specifically for LDetek specifications with properties to avoid interferences, temperature drift, loss of sensitivity and wavelength shifting over time. The wavelength, size, transmission lines and material are all critical characteristics that need special care to obtain such good performances.

The photo-diode will then convert the light out of the filter to current that is proportional of the amount of nitrogen in the sample. An electronic circuit designed by LDetek is then used for precision treatment of analog signal coming out of the photodiode.

Even if it sounds straightforward, LDetek has a unique way to install and align all items together. LDetek established rigorous procedures in a way to achieve high and same performances for each unit.



Figure 3: Plasma Detector module in the LD8000

FLOW CONTROL:

Flow management in such analyzer is critical in terms of dead volume and leakage. It is important to have a flow control device that will not introduce air and dead legs in the system. The LD8000 has an operating range as low as 0-1 ppm with a few ppb as detection limit. Conventional Mass Flow Controllers (MFC) is not suitable for such analysis. Since air is made of 78% of nitrogen, the chance to have some nitrogen introduced in the system with MFC is too high.

LDetek has designed its own flow control system to avoid air infiltration by the flow control device. The instrument can work with a flow as low as 25 cc/min and have a quick response time without apparition of dead volume.

Micro-Valve

LDetek have worked to develop a valve that meets the performances requirement. This miniature valve has a very small orifice size and offers ultra low flow rate. Since the LD8000 can work on relatively low flow, this valve design does not introduce delay or drifting problems.

Standard valves (figure 5) introduce “spikes” in the reading caused by dead volume located inside the valve. Measuring in so low concentration can be a big problem when having nitrogen released after calibration or upset condition in the sample.

With the LDetek micro-valve performance (figure 6), this problem is avoided and stable reading is obtained after any changes of concentration.

The inlet pressure can range from low as 4 PSIG to 30 PSIG without reading fluctuation. With an optional pump offered by LDetek, the instrument could work in even lower pressure.

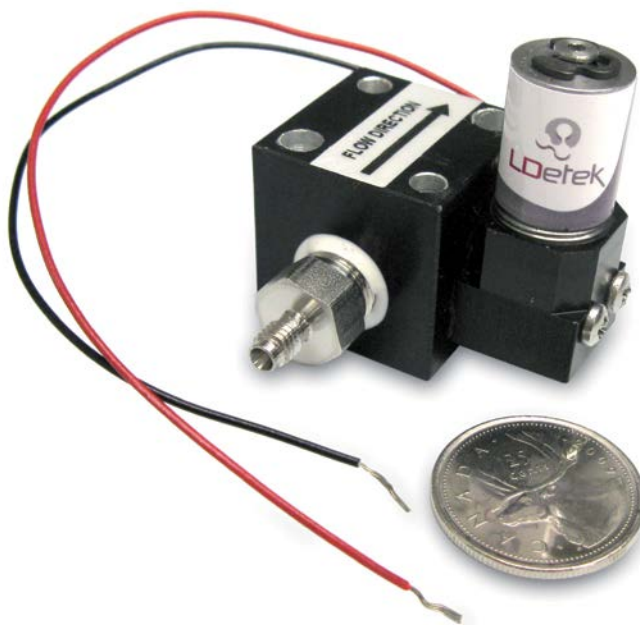

Figure 4: Micro-Valve for sample control

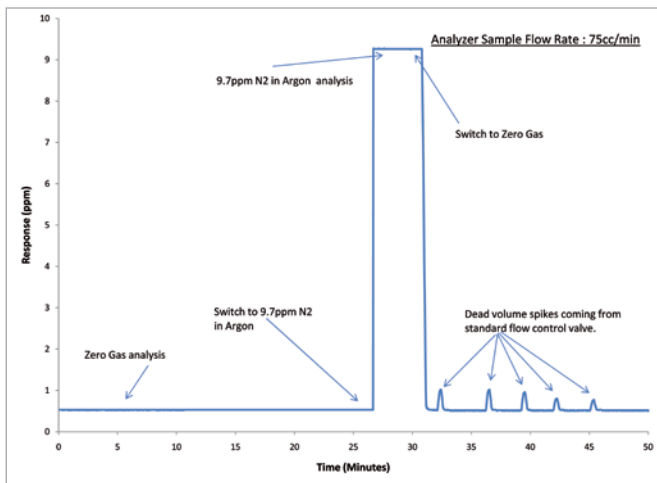

Figure 5: Standard valve performance

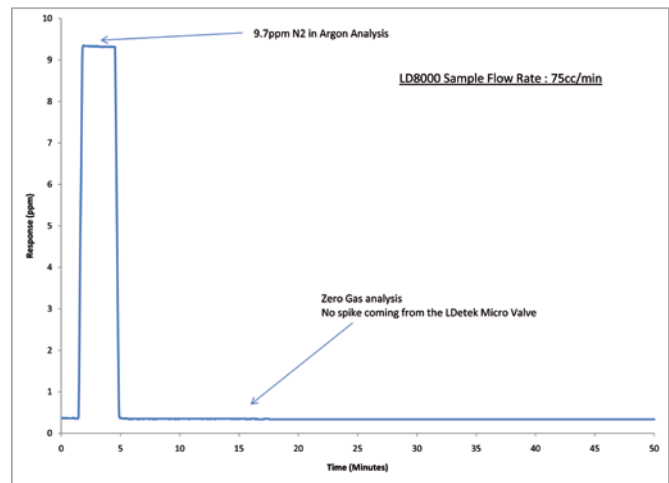

Figure 6: LDetek valve performance

Flow Transducer

The flow transducer is the biggest source of contamination for such analyzer. To avoid any problem with such device, the transducer is installed at the end of the flow path after the detector and is connected to the microcontroller unit to give information to the micro-valve to control a stable flow.

So why not using a MFC after the detector? That would avoid any chance of contamination or leakage? Actually, the PED must work at atmospheric pressure and it must not be pressurized. Since the PED is a cell made of quartz, it can break with a backpressure coming from the vent. Furthermore, you want to keep a constant pressure in the detector to get a stable plasma.

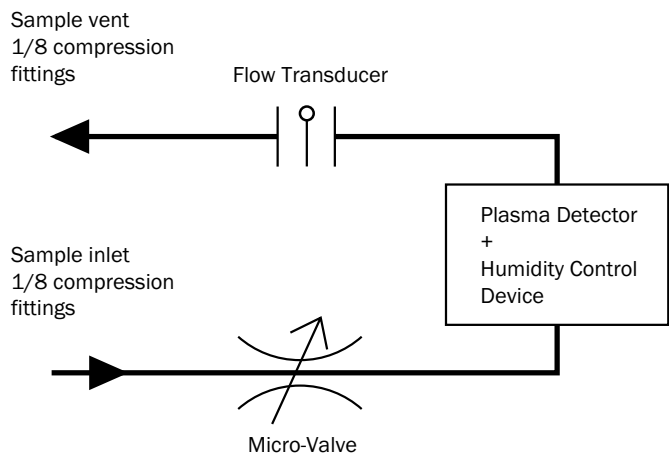

Figure 7: Flow path of the LD8000

NO NEED OF ZERO CALIBRATION GAS:

An option is available that avoids the need of a pure reference gas to make the zero calibration. The LD8000 can be designed in a way that components are added inside the analyzer to generate zero gas.

Only the sample gas is connected to the instrument and zero calibration can be achieved. A valve's system is used to change the flow path to the detector. During zero calibration, the sample goes to a small gas purifier to get pure argon or helium.

There is no consumable in such configuration. Since the integrated gas purifier is used only during zero calibration and the valve system isolates it, the lifetime of the purifier is extended. Such system will save the needs of pure argon supply, gas regulator, piping, external purifier, bypass valve for the purifier, etc. The payback is quite evident!

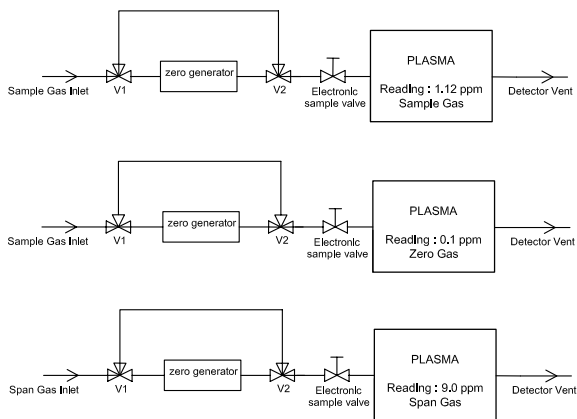

Figure 8: LD8000 with integrated zero calibrator

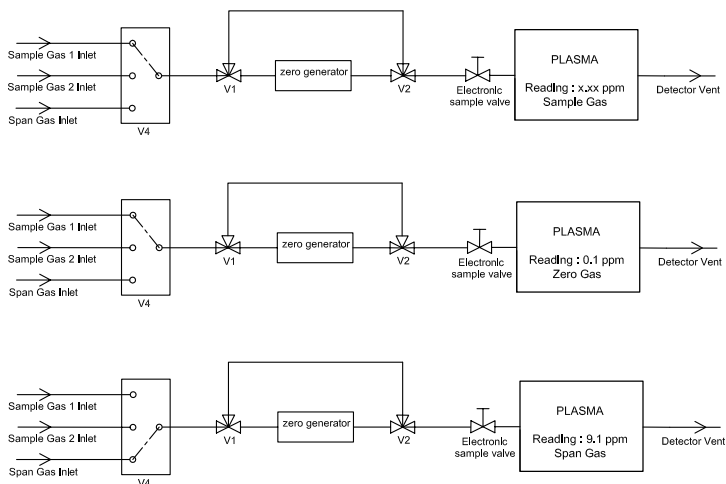

Figure 9: LD8000 with integrated zero calibrator & stream selector

HUMIDITY CONTROL DEVICE (HCD):

Moisture is the worst « enemy » of nitrogen in the plasma. First of all, its emission wavelength is closed to nitrogen and some interference can occur. Furthermore, the level of energy available in the plasma is more consumed by H₂O than N₂. That reduces the light intensity of nitrogen ending by a loss of sensitivity.

In each LD8000, a Humidity Control Device is included in the detector module. This device introduces a constant amount of H₂O and other chemical vapors compounds in the detector to stabilize the influence of the moisture on the measurement of N₂. With the combination of the moisture trap installed outside of the cabinet on the sample line, the analyzer becomes stable at any variation of humidity in the sample.

MAINTENANCE ? :

No maintenance is required in the analyzer. The detector is a non-depleting type device as well as the other components inside the cabinet. Same for the flow control system, however if a defective part needs to be changed, no need to change a complete and expensive flow module or MFC (Mass Flow Controller). You can replace only the micro-valve or transducer.

The unit has been designed in a way to make life easier if parts need to be changed. No need to send back the instrument to factory. Any kind of parts, including the detector module, can be replaced on site by a technician.

The moisture trap installed outside the analyzer should be replaced or regenerated every year to get the best performance in stability and accuracy of the LD8000.

ANALYZER PERFORMANCE

The design of the LD8000 brings outstanding performances for the market demand. Even if this analyzer is used for ppm measurement, we get stability, accuracy and noise level for ppb analysis. With the design described above, some tests have been done to show the performances in different situations. Those performances have been tested with argon sample, since it is the most popular application on the market.

RESPONSE TIME:

The LD8000 has a fast response time to ensure a good purity control in the different applications of such analysis. However, such good result is always dependant of the installation along with the instrument. The stream selector system is critical to be able to achieve such good response time. We strongly suggest to use the LDGSS from LDetek which has been designed specifically for such application.

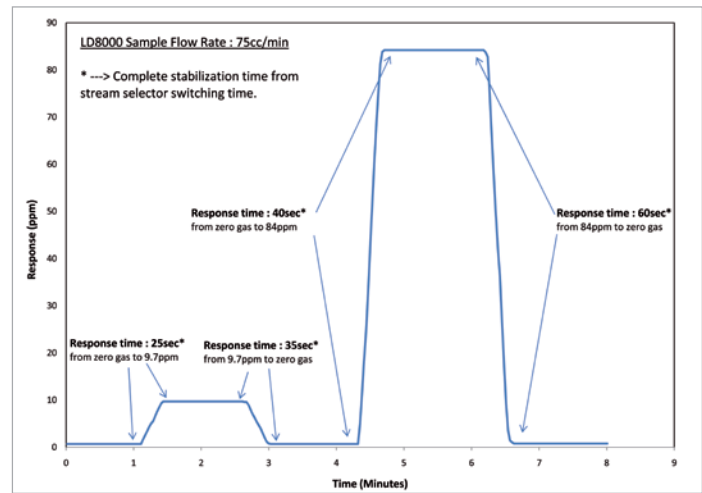

Figure 10:
*LD8000 Reponse time

NOISE:

The electronic for the acquisition of the detector has been designed to avoid any noise that could influence the reading of the analyzer. But more importantly, the design of the detector itself is very important to minimize the noise as much as possible. The position of the optical filter along with the photo-diode is critical to get the specification of the LD8000. Bad response of those components means electrical gain increase to achieve the measurement desired and at the same time the noise level will be amplified. When mounting the detector, special care is done by LDetek specialist.

The amplifier board used to manage the signal from the photo-diode was also particularly well designed. This board takes very low voltage to amplify it on a scale up to 0-10 volts.

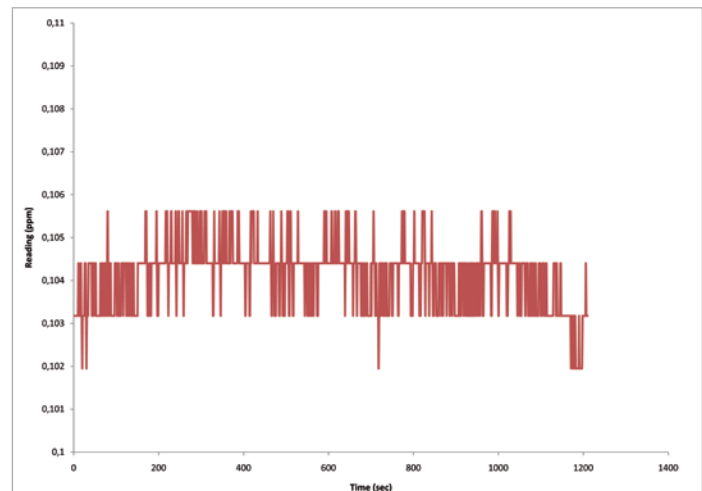

Figure 11:
*Noise level acquired on the analog output
with a sample gas of about 0.104 ppm

*Note: This result has been obtained in LDetek facilities with the LDGSS stream selector device with a well purged system according to LDetek standard methods.

STABILITY:

Stability of the analyzer has been evaluated through a few hours period. Temperature variation has been caused to show the stability of the reading even with an unstable temperature environment. Those variations have been done on the analyzer itself and not on the whole system installation which can be different from site to site.

With a deviation of 4.4 Celsius (31.6 to 36 degrees) on a 36 hours period, the reading has moved down from 300 ppb to 280 ppb. This slight variation gives a 4.5 ppb / Celsius change. Considering that most of the installations are temperature controlled, no temperature effect will be observed. Moreover, the resolution of the analyzer is 10 ppb and slight temperature variation will not be seen by the software reading.

Stability has been evaluated on a 24 hours basis with stable environment (figure 13). The drift observed is less than 2 ppb.

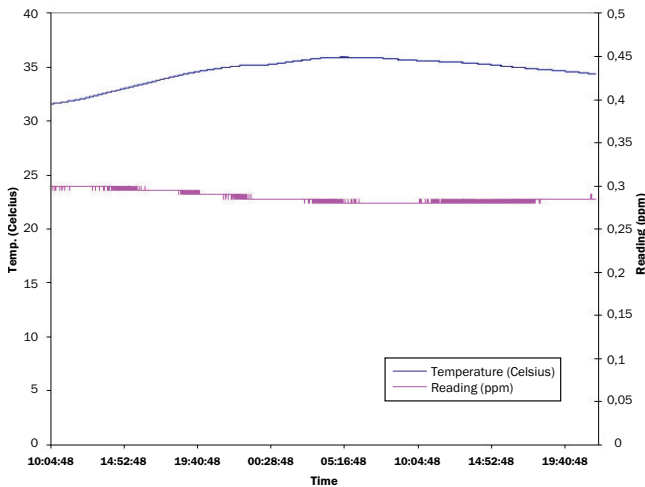

Figure 12: *Signal versus temperature

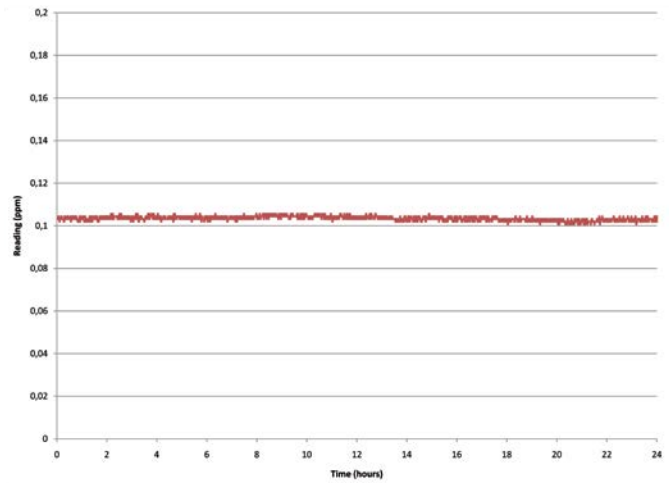

Figure 13: *24 hours stability on stable environment

LINEARITY AND ACCURACY:

Special care has been made on the linearity of the system. Knowing that existing instruments on the market do not offer linearity on the complete range of 0-100 ppm, LDetek has improved its detection system to be sure that working and calibrating the instrument on the range 0-100 ppm will offer the best performance.

On figures 14, calibration of the instrument has been done with a zero gas going through the LDP1000 gas purifier and the same dilution system for the different concentrations measured.

We have also made step changes in low concentration to show the accuracy of the instrument. Figure 15 demonstrates that a 10 ppb step change is easily detectable by the LD8000. Measuring pure gas on the range 0-1 ppm is more and more popular and such performance is appreciated from gas producers.

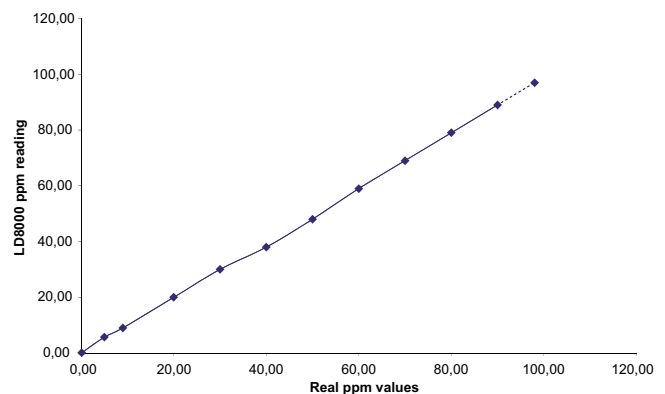

Figure 14: *LD8000 linearity on 0-100 ppm range

*Note: This result has been obtained in LDetek facilities with the LDGSS stream selector device with a well purged system according to LDetek standard methods.

DETECTION LIMIT:

Referring to the noise of the LD8000 from figure 11, we get maximum 3.6 ppb peak to peak. Using the standard deviation method, we have used 15 consecutive points where we get the maximum peak to peak noise. Five times the standard deviation gives a LDL of 4.4 ppb.

This kind of instrument is mostly used for concentration higher than 100 ppb. The LDL is low enough for all Air Separation Unit or glove box application.

If LDL lower than that is required, LDetek is manufacturing the LD8000-Plus, which is the ppb version of the trace Nitrogen analyzer. We can detect lower than 1 ppb with signal to noise ratio very low. Please contact factory.

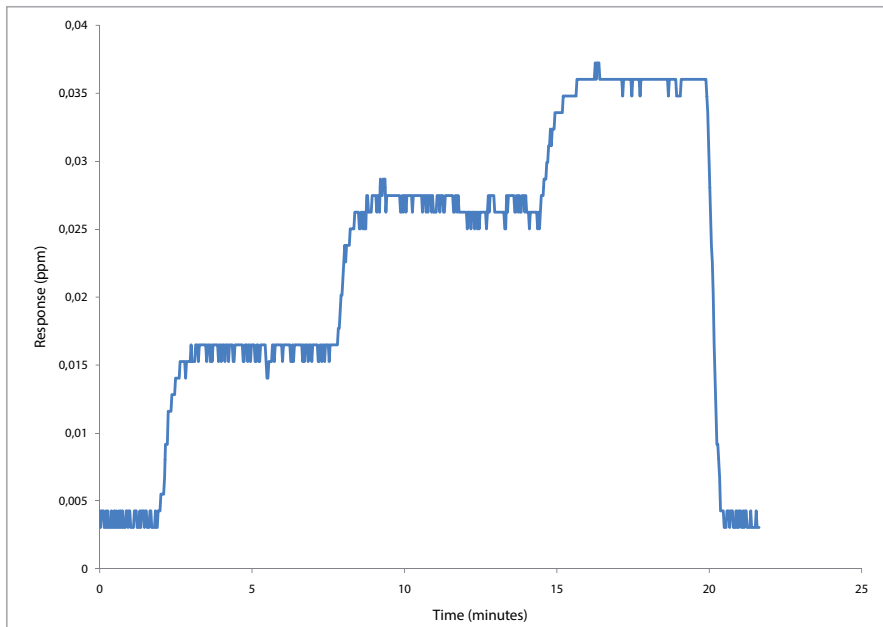

Figure 15:
*10 ppb concentration step changes

*Note: This result has been obtained in LDetek facilities with the LDGSS stream selector device with a well purged system according to LDetek standard methods.

CONCLUSION:

LDetek has put a lot of effort and time to introduce on the market a trace nitrogen in argon or helium analyzer with outstanding performances. We are proud to offer a reliable instrument that has been carefully designed with specialists having over ten years experience in trace nitrogen measurement and plasma emission detector.

For more information, comments or questions, don't hesitate to contact LDetek (info@ldetek.com).

APPLICATION NOTE

LD12-05



IMPROVING GAS CHROMATOGRAPH MEASUREMENTS WITH THE USE OF THE LDP1000 GAS PURIFIER

When measuring low level of impurity by gas chromatography, the carrier gas quality is quite important. Since the carrier gas is the reference gas for the device, good precaution to provide pure carrier is required. Using a grade 5 (99.999% pure) or grade 6 (99.9999%) is not enough in some cases. Even more, it is well known that many problems can simply come from the use of a bad quality gas cylinder or leakage on pressure regulator after cylinders manipulation. By using the LDP1000, it gives the certitude it catches all impurities coming from the carrier gas lines although you have sources of contamination.

The LDP1000 purifies noble gases, nitrogen or hydrogen at level that give the best reference for any gas chromatograph and GC/MS. It's non-evaporable zirconium-based getter alloy is contained in a 316L Stainless Steel bloc to ensure high purity and safe operating mode. It removes impurities down to ppt level (total impurities).

LDP1000 DESIGN:

The LDP1000 gas purifier is designed to be used with any noble gases, nitrogen or hydrogen. Its changeable getter gives the possibility to avoid changing the whole unit but only the consumable parts inside. That is a cost effective solution for long term use.

Having an accurate temperature control for such purifier is critical. The LDP1000 is based on a microcontroller unit that regulates the temperature of the getter to ensure stability on the purity and maximum purification. An over temperature protection is also in place to ensure safety of the unit.

Its mechanical design allows to use it on a table in a laboratory as well as in the industry with its holding plates. The bypass plate option gives also the necessary installation for maintenance purpose to avoid contamination and flow shutdown to the gas chromatograph.

AMBIENT VS HEATED PURIFIERS:

Since the entirety of the alloy volume is used, the heated LDP1000 adds to the purifier capacities and life time in comparison to any conventional ambient purifiers and/or traps. Heating the alloy makes the impurity molecules diffuse into the bulk of the getter particles instead of only relying on surface absorption like ambient purifiers. Moreover, the LDP1000 technology has the capacity to remove nitrogen, hydrogen and methane in noble gases.

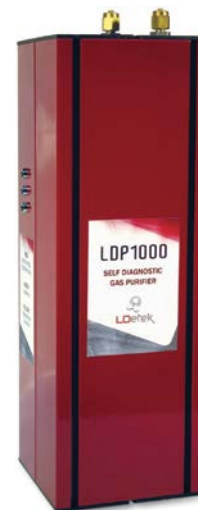

LDP1000
gas purifier

CONTAMINATION INFLUENCE:

It is well known that a contaminated carrier gas in a gas chromatograph has a big impact on the stability, sensitivity and performances of the system. Picture 1 shows the impact on the nitrogen reading while having a contaminated carrier gas.

Having a carrier gas contaminated, but less than the sample gas to measure, we lose sensitivity by the amount of the contamination. From the picture 1, we clearly see that we lose about 50% response with a sample/contamination ratio of 2. That affects significantly the detection limit of the system.

It is even worse when the contamination is higher than the sample to measure. Since the sample is more pure than the carrier gas, you get a negative peak for the impurity. The measurement is completely erroneous and cannot be used.

The LDP1000 ensures that the carrier gas of the system is at its best purity you can get. This way, the gas chromatograph can have the best performances for all its measurements.

Referring to picture 2, the impact of bad carrier quality on a gas chromatograph system is clearly demonstrated. The chromatograms used to do the demonstration are the same that the ones used in picture 1 which are contaminated with different level of air.

The noise level increases with the level of air contamination. That makes the signal/noise ratio lower. That has also a direct impact on the performances of the system by degrading the columns stability and separation. It can even lead to capillary column destruction.

Having the LDP1000 installed on gas chromatograph keeps the system stable and extends the lifetime of the whole system hardware by removing any trace of particles and air contaminants.

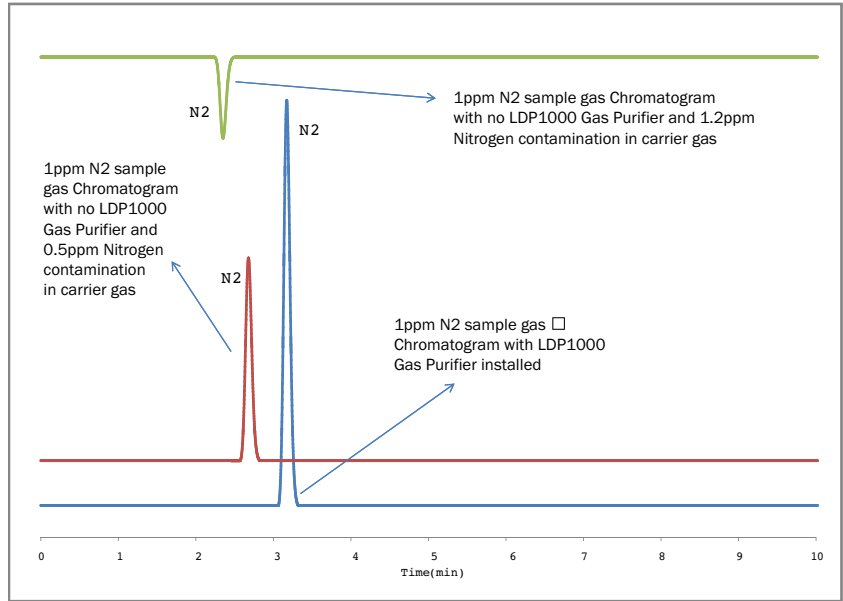

Picture 1: N₂ contamination influence

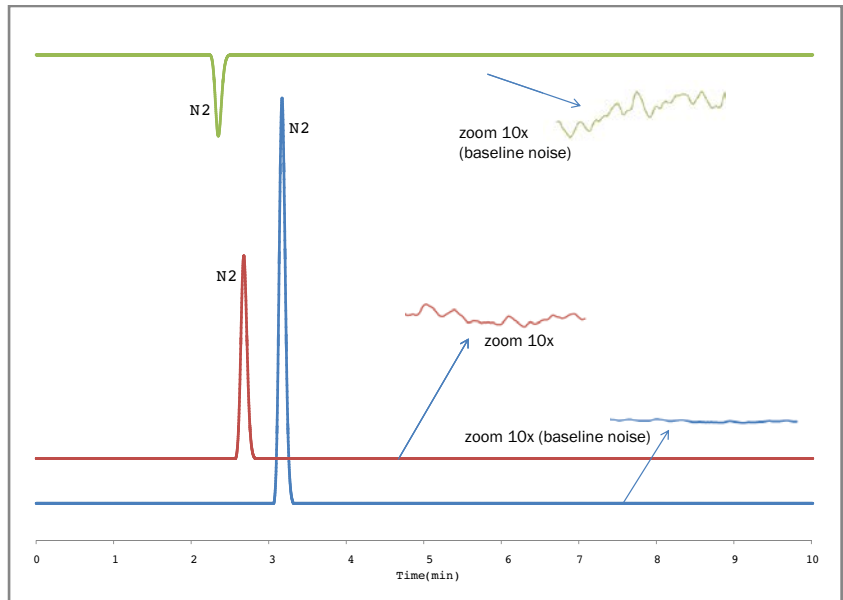

Picture 2: Contamination influence on noise level

TWO BEDS OF PURIFICATION:

To ensure high purity, the LDP1000 noble gas version has two beds of purification. The first stage has an elevated temperature grabbing all components except some low level hydrogen. At this temperature, some H₂ can be released from this bed. The amount of H₂ can be as high as a few hundreds ppb with the use of one stage of purification only.

By having a second bed of purification operating at a different temperature, the hydrogen out of the first stage can then be totally trapped.

Both bed temperatures are controlled by a microprocessor ensuring stability and efficiency of the purifier.

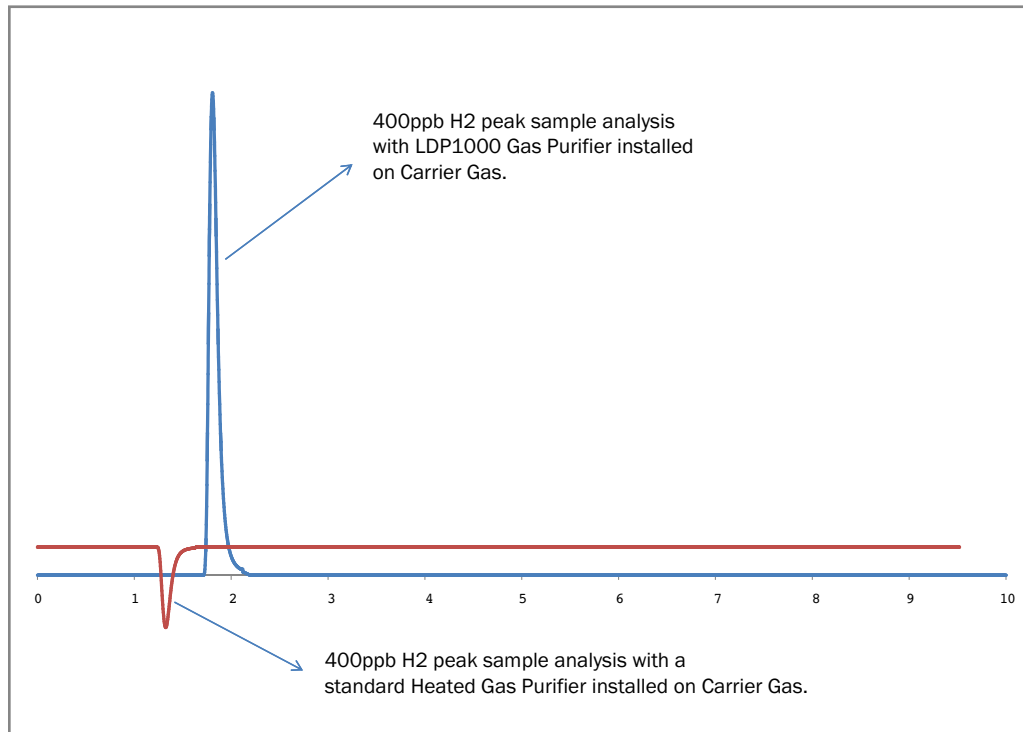

Picture 3: Hydrogen influence on measurement with different purifiers

Having H₂ released from the first bed could influence your H₂ measurement considerably. Such phenomenon is known in the gas chromatography industry when measurement of low level hydrogen is necessary. A part of the hydrogen comes from the cracking of methane and non-methane hydrocarbons. The cracked by-products are then sorbed by the getter. However, the sorption capacity for H₂ isn't high enough caused by high temperature which makes some low level hydrogen come out of the getter.

Picture 3 shows the effect of H₂ presence coming out of a purifier in the carrier gas when only one stage of purification is used. Then, if the sample gas is more pure than the carrier gas, you will reduce sensitivity and even get negative reading for hydrogen in some cases, as illustrated on picture 3. With its two beds of purification, the LDP1000 removes completely the presence of H₂ in the carrier which is ideal for low measurement.

LEDS INDICATION & RS232 COMMUNICATION:

The LDP1000 has intelligent features to be able to monitor some information:



Picture of the LDP1000 LED

- **Green LED**
Indicates that the LDP1000 is powered ON
- **Yellow LED**
Indicates if one of the beds has a temperature deviation
- **Red LED**
Indicates that the lifetime of the purifier has expired.
Getter needs to be replaced.

Those indications are very useful to know that your system is fully working or the purifier is not the cause of any performance issue you can have with your gas chromatograph. The diagnostic and control of those LED's is fully managed by the microcontroller and the different sensors in place.

A RS-232 serial port is also installed by default on the LDP1000. This feature gives the possibility to monitor the temperature of the 2 beds of purification. This is very useful for troubleshooting the device.

CONCLUSION:

With the LDP1000, the carrier gas quality becomes indisputable. With its specific mechanical and electrical design, the gas purity level has never been so good and stable. It is a must for the gas chromatography and GC/MS industry. Moreover, with its changeable getter, this may be the last gas purifier you will ever buy. The LDP1000 is the cost effective solution you need.

LD2000



TRACE TOTAL HYDROCARBONS ANALYZER

DESIGN REPORT

3.0 APPLICATION NOTES



Measuring total hydrocarbons is required in the air separation industry for quality control of the gas produced. The series LD2000 is an online analyzer using a flame ionization detector especially designed for this application. This document will demonstrate the performances of the unit.

ANALYZER COMPONENTS

FLAME IONIZATION DETECTOR (FID)

DETECTION PRINCIPLE

It is well known that due to its relatively good sensitivity to most organic compounds, the FID is a good detector for measuring the level of THC in different sample gases. The principle is based on the creation of carbon atoms (ions) formed during the combustion of the organic compounds burned by a hydrogen flame.

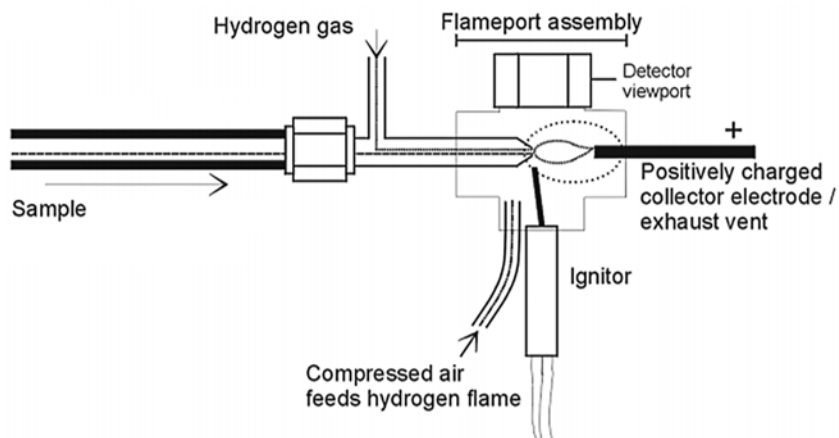

AMPLIFIER

The signal on the collector is amplified with our multi-stage amplifier which has been designed to satisfy the different ranges required. Different sample rates are adjustable to optimize the sensitivity of the signal.

FLOW CONTROL

The sample flow is controlled with the LDetek electronic proportional valve to ensure stability. Concerning air and fuel, the flow control is adjusted with a stainless-steel mini pressure regulator. A safety shutoff valve is installed on the hydrogen gas line to close the fuel when the flame goes off.

FEATURES

The unit offers all the industrial communication protocols with alarms for data/results collection.

MAINTENANCE

It is recommended to replace the hydrocarbon traps for air/fuel once a year to ensure integrity of the flame by avoiding any trace of hydrocarbons coming from the feeding gases. Depending on the carbon level, the FID collector and ignitor are to be replaced every 2 to 3 years to avoid any lack of sensitivity.

ANALYSER PERFORMANCES

RESPONSE TIME

The response time of the unit is demonstrated on the figure 1. Upfront and down front time is of 60-90 seconds depending on the concentration and also the sampling system design. Such response time satisfies the requirements.

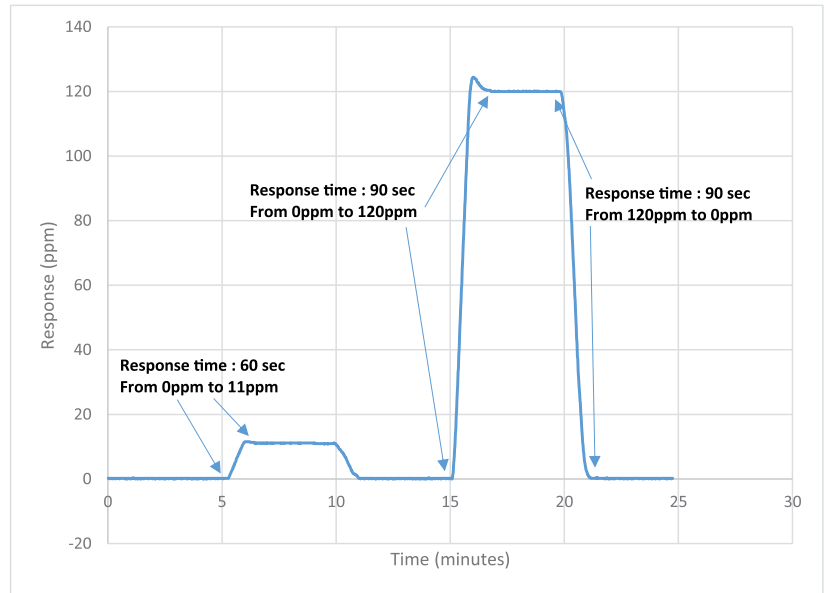

Figure 1

LINEARITY/ACCURACY/REPEATABILITY

The linearity curve of the analyser (figure 2) is 0.99 and has been performed using 13 points diluted at different concentrations between 0-560ppm. The same span bottle has been used for the dilution and the calibration to avoid concentration shifting due to different bottle certifications.

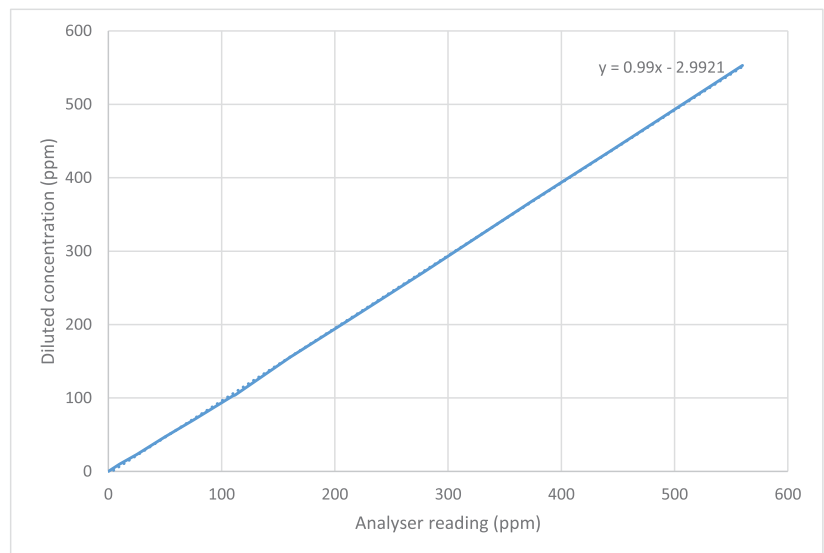

Figure 2

The accuracy error is +/-1% of full scale. The figure 3 shows the % error for 13 points diluted at different concentrations between 0-560ppm and measured on a 1000ppm scale.

The repeatability error is +/-1% of full scale in a stable environment.

Diluted concentrations *(ppm)	Analyser reading (ppm)	Accuracy (% of scale)
0	0	0
10	10	0
25	23	0.2
50	47	0.3
75	70	0.5
110	103	0.7
112	104	0.8
160	155	0.5
210	204	0.6
280	273	0.7
373	367	0.6
444	437	0.7
560	553	0.7

Figure 3

*The dilution system and the certified bottle combined together may give an additional source of error of +/- 1% depending on the conditions.

DETECTION LIMIT (LDL) AND NOISE

Referring to the figure 4, the peak to peak noise level is 50ppb based on the 40 minutes period. A factor of 2 times the noise level is applied to give an LDL of 100ppb.

To demonstrate the response limit, some concentration step changes of 200-250ppb have been done. The figure 4 well shows the performances of the unit on its 10ppm range.

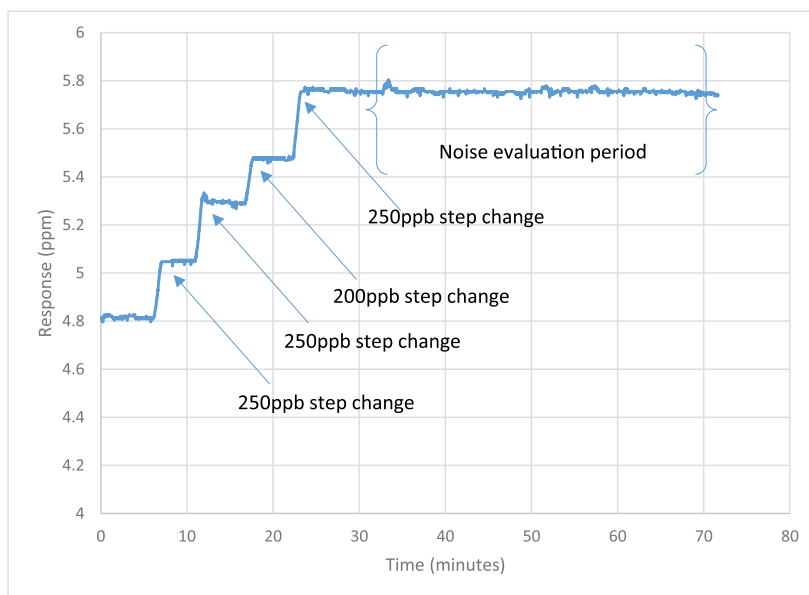

Figure 4

STABILITY/DRIFT

Running on a 4 days period at a concentration of 22ppm on a scale of 100ppm in a stable environment, the instrument reading delta shows 1.9ppm which is in the specification of +/-2% of full scale for a one-week period in stable conditions.

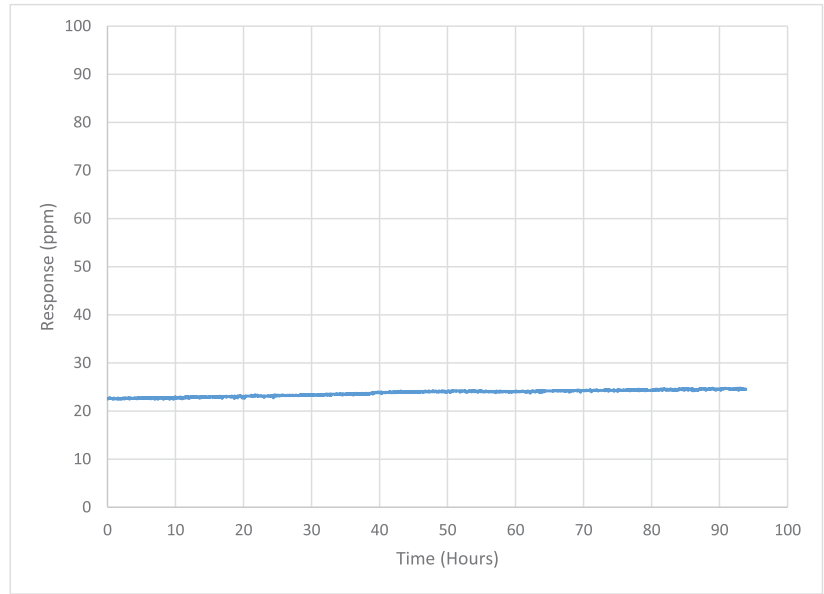

Figure 5

MULTIDETEK2 GC



WITH INTEGRATED MODULE FOR TRACE MOISTURE ANALYSIS

DESIGN REPORT



3.0 APPLICATION NOTES

The Advanced Quartz Crystal Microbalance sensor from Michell Instruments is now integrated inside the MultiDetek2 GC to provide reliable, fast and accurate measurement of trace moisture content in a variety of applications where keeping moisture to a minimum is of critical importance.

The analyzer provides consistently accurate measurements of trace moisture. This consistency is achieved using a self-calibration system, which adjusts the sensor with reference to an internal moisture generator. The moisture generator is supplied with a calibration traceable to NPL and NIST, so long term stability of its measurements is guaranteed.

Having such module inside a GC allows to combine multiple impurities analysis with trace moisture inside the same instrument.

DETECTION PRINCIPLE

Sensor: Quartz crystal microbalance

A quartz crystal is sensitised with a thin film of hygroscopic material.

- ▶ Water molecules are adsorbed into the hygroscopic layer deposited on the surface.
- ▶ The change in mass modifies, in a very precise and repeatable manner, the oscillation frequency.
- ▶ The moisture concentration is measured as a change in the oscillation.
- ▶ The change in the oscillation is evaluated by switching the gas inside the sensor and by measuring the response delta. For sampling response, the sensor is balanced between a dry gas source and the sample source. The difference is then calculated. The same principle is applied for the span gas calibration. However, this time the comparison is between a dry gas and a source of wet gas. A cycling time of 30 seconds on each gas is used to compare the response delta.

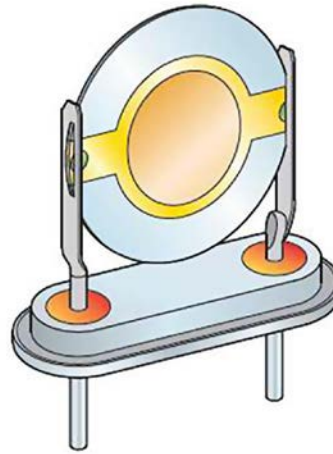

Figure 1:
Quartz crystal sensor

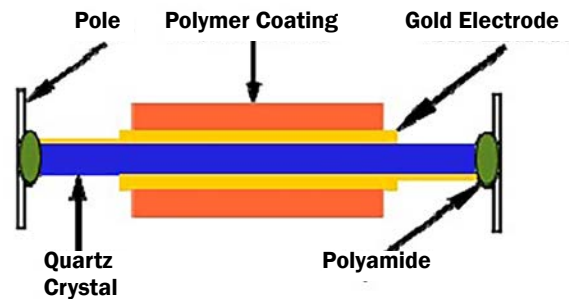
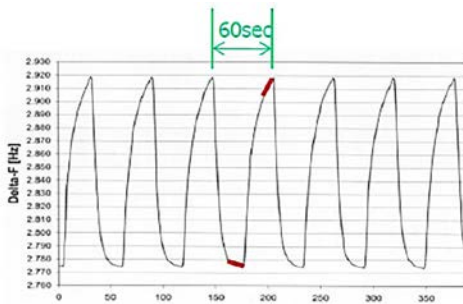

Figure 2: Quartz crystal principle

$$\text{Measurement } \Delta f = \text{primary } \Delta f_{\text{sample}} - \text{primary } \Delta f_{\text{dry}}$$

- 30/30 sec measurement cycle
- Non-equilibrium for fast response
- Self-cancelling effect for contamination

- ▶ The dry gas comes from the carrier gas source of the GC. The sensor is supplied by a known Helium or Argon or Nitrogen grade 5.0 carrier source going through a heated gas purifier model LDP1000 series. This combination generates a gas purity of 8N. By using this technique, the dry gas source contains less than 10ppb H₂O what is ideal as zero gas reference.
- ▶ The wet gas comes from a certified water filled permeation tube heated at a controlled temperature of 45 Celsius. It generates

a stable amount of moisture used for span calibration. The moisture generator is made of coated stainless steel to reduce the surface absorption of water molecules and then keep the moisture rate very stable and accurate.

- ▶ The flow inside the module is controlled and maintained by a network of calibrated orifices. All flow passageways upfront the sensor are less than 0.030"ID, all coated with an inert coating to accelerate the response/purge time and improve the performances of the system.

FLOW DIAGRAM

Sampling position:

The V4 diaphragm valve switch between sample gas and dry gas every 30 seconds. The response delta between the dry gas and the sample gas is then measured at the quartz crystal module (QCM). The flow rate inside the sensor is stabilized at 100sccm by the flow orifice R11 mounted at the outlet of the sensor. Two balanced flow orifices R8-R10 keep an equal flow rate of 100sccm to be sure the system stays in equilibrium even with valve switching. This technique ensures the system stabilizes very quickly. This sampling position is the normal running mode and a refreshed reading is proceeding every 60 seconds.

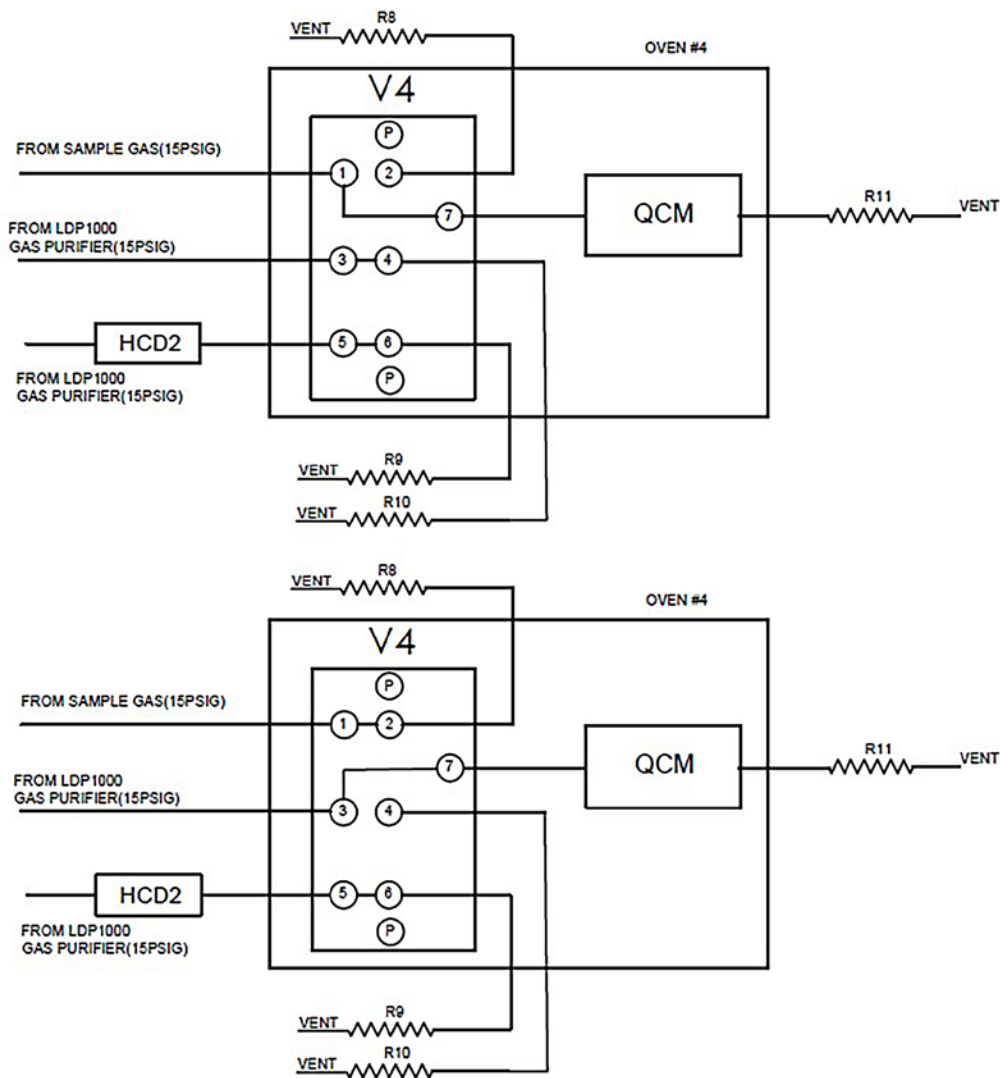

Span calibration position:

The V4 diaphragm valve switch between the dry gas and the wet gas every 30 seconds. This position is used for span calibration purpose. The span calibration frequency depends of the requirements but is generally required every 2 weeks for check spot. During this process, the V4 valve switches every 30 seconds to compare the response delta between the wet gas to the dry gas. Again, the flow is balanced with R9-R10 flow orifices. The humidity control device (HCD2) is continuously kept under a fix flow rate at a stable temperature of 45 Celsius in an inert coated controlled environment. The permeation device generates a certified and known moisture ppb rate. The concentration generated depends on the application, but is generally 500ppb. Having the calibration performed at the bottom of the scale increase the accuracy of the system in the most critical reading region.

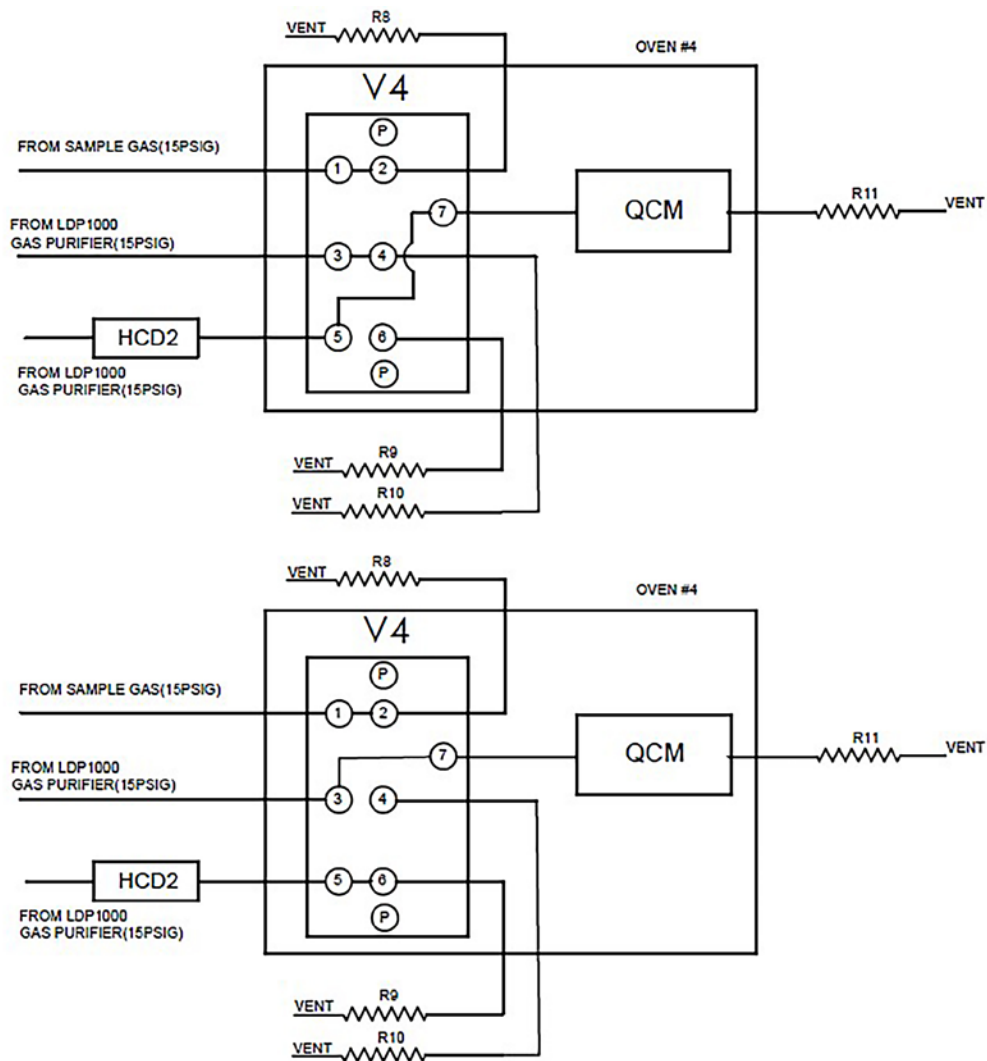

MODULE ASSEMBLY

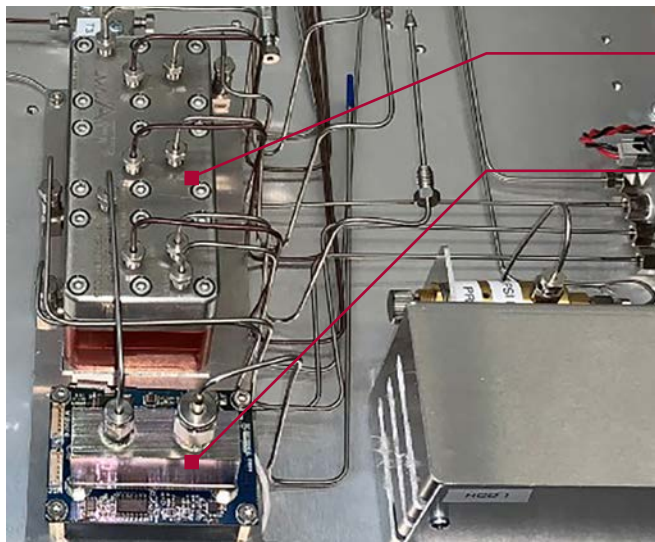

■ 3 streams, inert coated stainless-steel diaphragm valve with sample bypass and purge

■ Trace moisture sensor (quartz crystal microbalance)

*All flow passageways to the sensor are made of stainless steel inert coated with an ID of 0.030"

■ Moisture generator (certified permeation tube) maintained at a fixed temperature

■ Solenoid valve and manifold to actuate the diaphragm valve

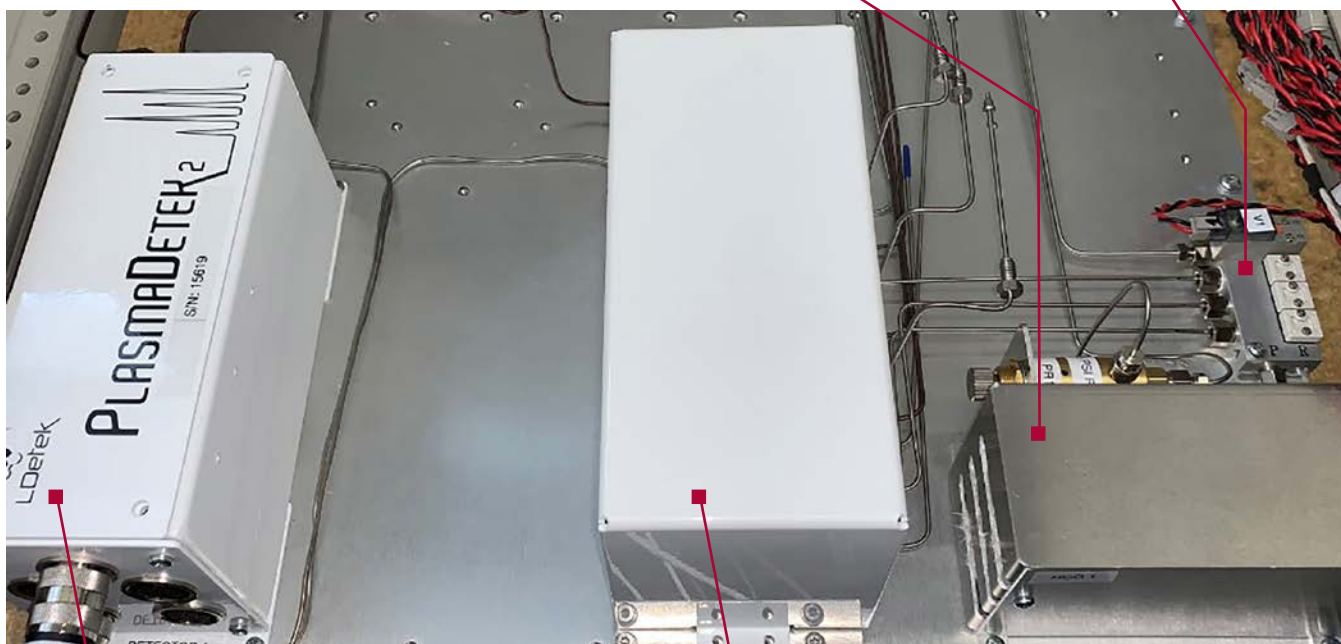

■ PED sensor integrated inside the same GC unit to allow other impurities analysis in one GC

■ Temperature controlled module for the sensor and the valve assembly

MAINTENANCE

The system is built to be resistant and simple of operation with minimum interventions. A routine maintenance interval every 5 years for replacing the moisture generator, the gas purifier and the diaphragm of the valve is required. The unit has been designed in a way that replacing those components is very easy. In addition to that, the 5 years period is very long what is appreciated to keep the maintenance tasks at its minimum. These tasks are at the same frequency that the ones required inside the GC. So, a GC check can be done every 5 years for all modules together.

ANALYSER PERFORMANCES

RESPONSE TIME

Different steps of 1ppm, 5ppm and 10ppm have been tested to demonstrate the response time at different concentrations. The response time either on upfront or down end steps remains at about 4-5 minutes. The readings are updated every 60 seconds. The flow path design having low internal volume (0.030"ID) and the purged diaphragm valve makes the system being very quick to respond. On top of that, the system is coated with an inert coating to keep the surface absorption as low as possible to avoid signal drifting. Also, no flow control hardware has been mounted inline with the sensor. The system is configured with bypass flow controller to avoid response delay normally caused by residual dead volume in a standard flow controller.

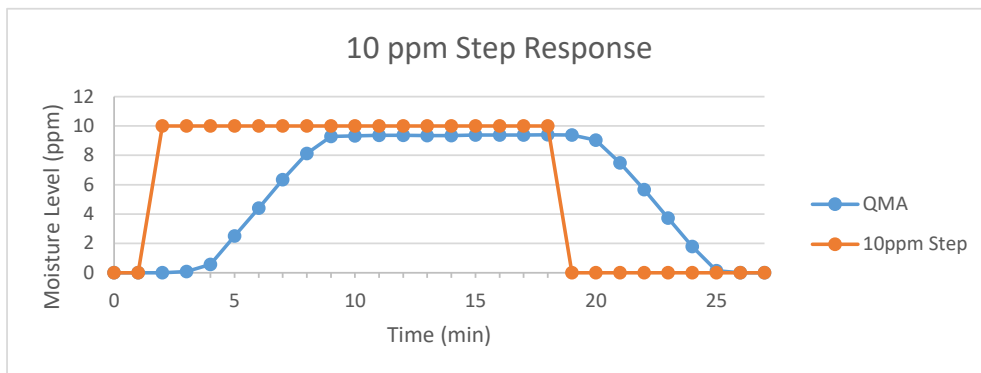
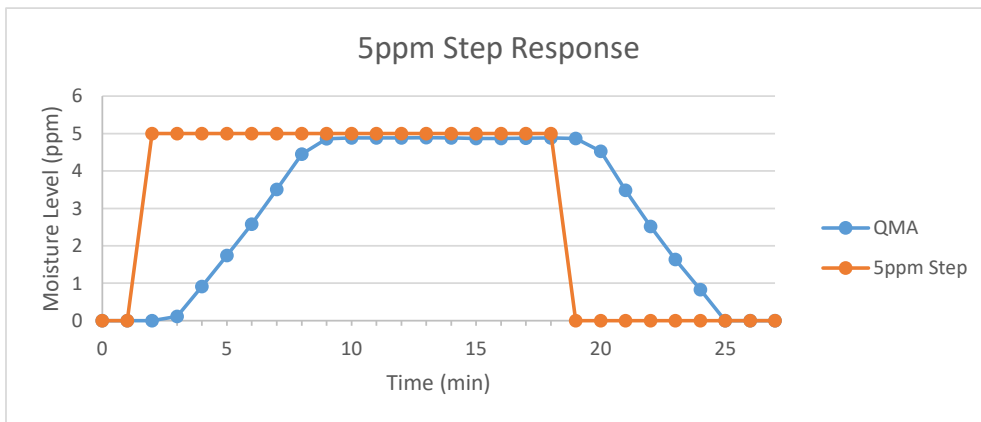
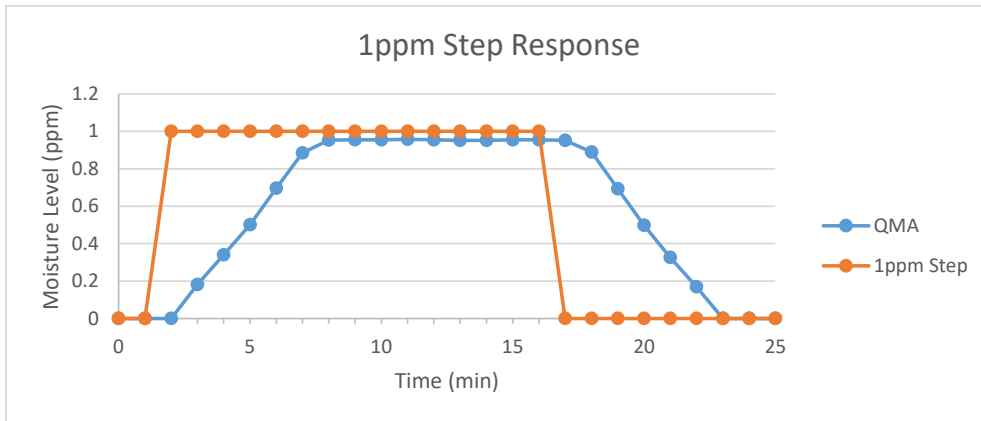

LINEARITY/ACCURACY/REPEATABILITY

The system is fully linear due to the linearization rectification of every sensor. Each system is characterized in function of its full range to ensure the respond is linear. A series of multiple points at different concentration within the scale are performed.

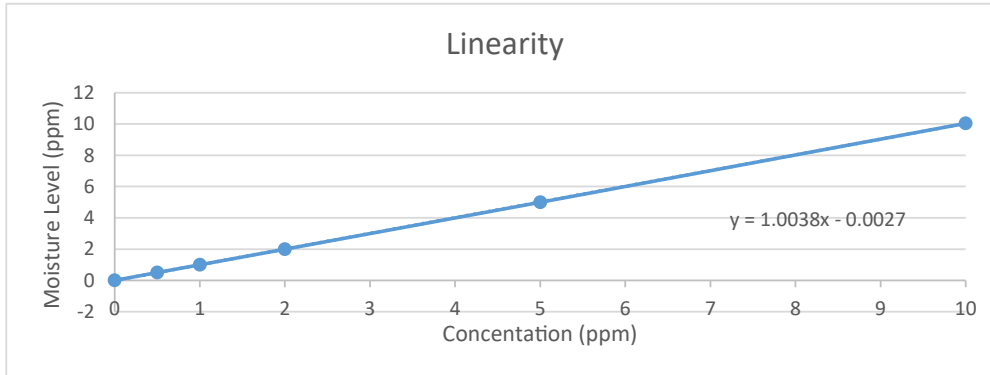

The accuracy error is +/-1% of the scale. In this instance, the table below shows the % error for 6 points diluted at different concentrations between 0-10ppm.

The repeatability error is +/-1% of the scale in a stable environment.

Diluted concentrations *(ppm)	Analyser reading (ppm)	Accuracy (% of scale)
0	0	0
0.5	0.505	+0.05
1	1.004	+0.04
2	1.999	-0.01
5	5.04	+0.04
10	10.042	+0.42

DETECTION LIMIT (LDL) AND NOISE

Multiple steps at a concentration of 25ppb of moisture have been performed to demonstrate the lowest detection limit (LDL). The steps are repeatable and clearly show a good response. Considering a maximum noise level equivalent to 0.002ppm(2ppb) at a concentration of 0.2ppm(200ppb) represented by the zoom section, then 5 times this noise level brings the ldl at a value of 10ppb.

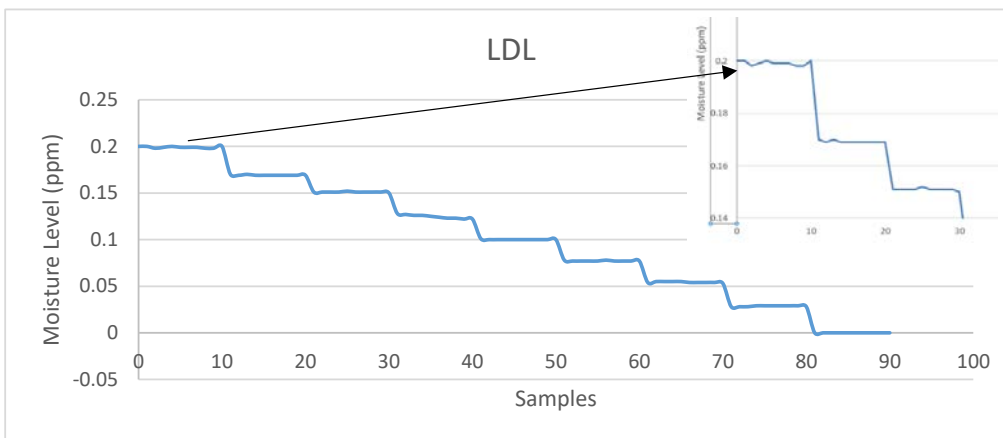

STABILITY/DRIFT

Stability/drift

To evaluate the stability and drift of the unit, a gas bottle containing 8.5ppm moisture in a balance of helium has been connected as sample gas. The system was offering a stability of better than +/- 2% on 24 hours+ period.

8.61ppm (maximum reading) - 8.50ppm (reference value) = 0.11ppm (+1.1%)

8.5ppm (reference value) - 8.44ppm (minimum reading) = 0.06ppm (-0.6%)

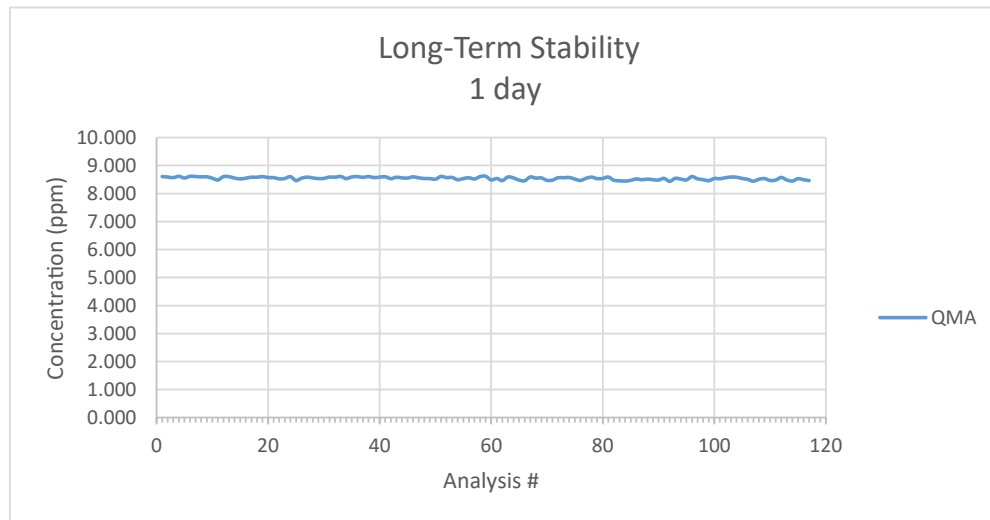

CONCLUSION

LDetek is proud to be the first GC manufacturer capable of bringing an innovative and highly performant trace moisture module inside its gas chromatograph MultiDetek2 series. Its presence in LDetek 's portfolio offers the market the possibility to combine many impurities measured by gas chromatography along with an integrated online trace moisture module inside one instrument.

LD8000-MULTIGAS



CONFIGURED FOR CRYOGENIC HELIUM APPLICATION

DESIGN REPORT



▲ LD8000 MultiGas

▲ PlasmaDetek2

3.0 APPLICATION NOTES

This technical document follows the application note LD16-06 on the use of LD8000-Multigas for the quality control of helium used in cryogenic stations.

The measurement of the trace impurities N₂-O₂-H₂O-CnHm in a helium or argon matrix can be carried out with a PED type detector (PlasmaDetek2) US patent 9,310,308 B2 integrated into an instrument of the LD8000-Multigas type. This technology is based on cold micro-plasma excited at high voltage / frequency in a helium atmosphere and allowing the selective measurement of each component at a precise optical wavelength. The optical circuit is composed of photodiodes and interference filters combined with an amplification system for converting the measured photons into voltage. All signal processing is then redirected to a microcontroller.

Several variants and options on this device are possible depending on the needs of the customer. In this document, we will explain three types of assemblies possible for applications in a helium matrix.

Figure 1 shows an installation where the required measurement must be configured for the following ranges (low to high ppm configuration):

IMPURITIES	N ₂	O ₂	H ₂ O	CnHm
Range	0-300 ppm	0-50 ppm	0-100 ppm	0-30 ppm

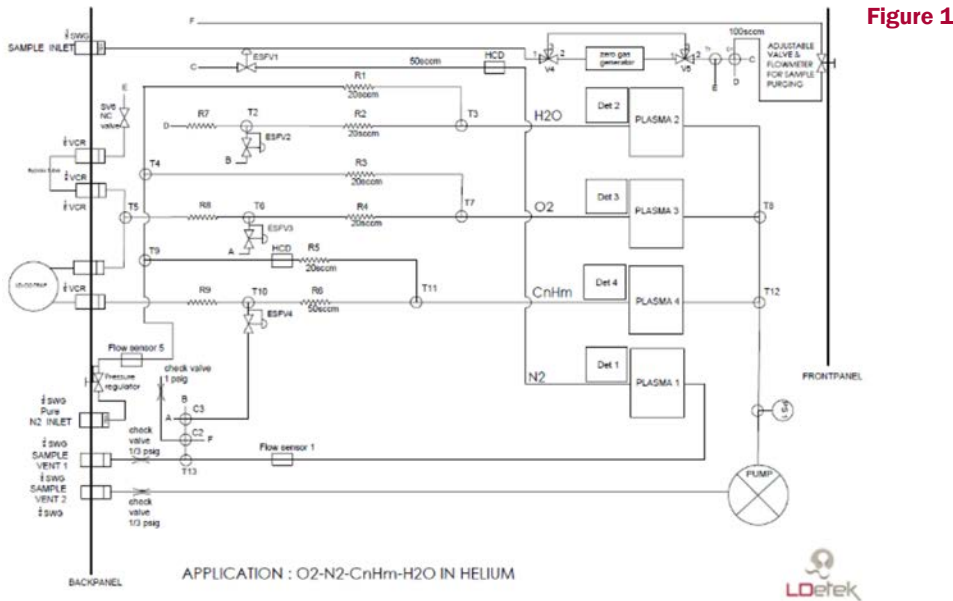

Figure 1

Figure 1 demonstrates an instrument configured as follows:

- Four plasma detectors have been installed in the instrument for N₂-O₂-H₂O-CnHm measurement. Each detector is configured with a narrow optical interference filter providing an optical response specific to the measured impurity. Each plasma is a monolithic structure made of quartz through which a pipe allows a linear gas flow. Through this linear flow, a scanning by an electric discharge is applied. This discharge is called “dielectric” because these electrodes are mounted externally of the quartz assembly. This ensures the inertia of the block internally being in contact with the gas. The discharge is said to be alternative to a specific high frequency and voltage.
- The N₂ doping input is required since the trace measurement of N₂ can reach 300ppm. The N₂ doping is then applied to the PEDs used for H₂O-O₂-CnHm measurement to eliminate the interference from the nitrogen beyond 10ppm. The nitrogen flow is generally controlled to the same value as the helium sample flow. We therefore speak of a ratio of 50% He / N₂. Figure 1 shows a value of 20sccm helium for 20sccm nitrogen. Total nitrogen consumption for the instrument is therefore 60ml/min. The nitrogen flow rate is controlled by static orifices pre-adjusted to a defined pressure. To ensure the stability of the nitrogen flow, a mini pressure regulator is mounted on the instrument as well as a pressure flow sensor. This assembly ensures the stability of the nitrogen flow rate which is very important for maintaining the N₂-He mixture equilibrium in the plasmas.
- A vacuum pump is required at the PED output used with N₂ / He mixture to allow the excitation of the PEDs performing the O₂-H₂O-CnHm measurement. The same pump is therefore common to the three PEDs. By this output, the measured flow is generally around 120 ml/min of a mixture of 50% He / N₂. The 2nd output, this one without a vacuum pump, is specific to the PED for N₂ measurement. The flow of helium on this output is 50ml/min from the PED for the measurement of N₂, and 3 x 50ml / min being the bypass flow rates of the 3 sample regulators for the O₂-H₂O-CnHm PEDs. To these flow rates, is added the bypass flow at the inlet of the device serving to purge the line upstream of the instrument generally set at 100 ml/min. The total flow of clean helium that can therefore be recovered by the customer is around 300ml / min. Consequently, it is a total flow rate of 300ml / min + 60ml / min, i.e. 360ml / min of helium that is consumed. It is therefore possible to recover more than 83% of the helium consumed by the instrument. A system of “check valve” out of the PED was set up to recover helium without the risk of pressurization of the PEDs. The internal pressure PED is therefore limited to 1/3psig avoiding any risk of rupture of the quartz.

- 4.** A zero-gas free system is installed to generate ultra high purity gas by flowing through a heated purifier and to do a zero calibration. It simply allows to use the sample gas of the customer and to purify it generating the 8.0 grade Helium (i.e., 99.999999%) having maximum impurity level of 10ppb. This purification allows to avoid a bad zero calibration and negative readings on the “process” gas of the customer. Moreover, there is no need for installation of an extra ultra-purity gas bottle with an external purification system, which is generally required by our competitors.
- 5.** Each PED has its own electronic flow control by pressure flow regulator to ensure stability of reading regardless of the inlet pressure fluctuation. All flow controllers are “bypassed” to prevent contamination of the sample and ensure the best possible response time at a small flow rate. Generally, systems measuring N₂-O₂-H₂O must operate at a high rate to allow a good sweep and dilution of the contamination to minimize drift and long response time. Thanks to our ‘bypass’ design, we can afford to keep small flows and limit the waste of Helium being generally very expensive.
- 6.** An O₂ trap with VCR connections is installed on the CnHm PED to eliminate oxygen interference on the CnHm measurement. This trap is composed of activated copper powder.
- 7.** Humidity interference is removed by HCDs (H₂O permeation tubes) installed on N₂-CnHm PEDs. Providing a stable concentration of moisture to the N₂-CnHm plasmas, they are saturated with water, removing the interference caused by moisture in the sample. If the presence of moisture in the sample is above 10-20ppm, then a second trap, this time to capture moisture, is required. It is also with VCR connections, consists of molecular sieve 3A. When it is not required, a simple “bypass” is mounted on the instrument.
- 8.** A software protection system against carbon deposits in the PEDs allows them to go out when the CnHm measurement rises above 3ppm (adjustable parameter). By cutting the excitation of the N₂-O₂-H₂O PEDs during high CnHm measurements, it is possible to prevent the degradation of the PEDs caused generally by the creation of carbon deposits on the walls of the monolithic quartz block.
- 9.** In this configuration, by using the nitrogen doping for the O₂ measurement, the nitrogen level is saturated and any form of interference from the N₂ concentrations is avoided. In addition, the installation of optional moisture trap allows to eliminate any interference on O₂ measurement from H₂O concentrations. The O₂ measurement shielded by its selective optical spectrum combined with N₂ doping and H₂O blocking by a trap can be used to compensate the N₂ measurement. This compensation is done at the software level by an algorithm.
- 10.** The tubing and fittings in contact with the line used for the H₂O measurement are treated with a water-repellent inert coating to minimize surface absorption and provide better temperature stability and response time.

INTERFERENCE SUPPRESSION SYSTEM:

The protection system of the PEDs in the presence of too high hydrocarbon measurements, combined with O₂-H₂O trap networks and the humidity and nitrogen dosing system allows the LD8000-Multigas to remove interferences between the impurities. This is a unique LDetek practice, allowing accuracy and prolonged lifetime of the detector.

In order to protect the H₂O and O₂ traps, they are isolated by a “ shut off ” valve when the N₂ measurement rises above 200ppm (adjustable parameter). The logic behind this protection is based on the fact that if the N₂ measurement rises to a high level, then there is a strong possibility that it is an air infiltration and the same fact increases the O₂-H₂O concentrations. So, as long as the N₂ measurement remains high, a protection preventing the sample from going to the O₂-H₂O traps remains activated.

Table of effects caused by interferences*:**

SAMPLE*	10 PPM N₂ O₂ CH₄ H₂O	10 PPM N₂	5 PPM N₂	10 PPM O₂	10 PPM N₂ O₂ CH₄
N ₂	10 ppm	10 ppm	5 ppm	0 ppm	10 ppm
O ₂	10 ppm	0 ppm	0 ppm	10 ppm	10 ppm
CnHm	10 ppm	0 ppm	0 ppm	0 ppm	10 ppm
H ₂ O	10 ppm	0 ppm	0 ppm	0 ppm	0 ppm

*The balance of the sample is helium.

*** Other combinations have been tested successfully, so have not been presented in this table. Only critical interference has been presented in this table.

MAINTENANCE:

Frequency 12-18 months:

Regeneration of O₂ and H₂O traps depending on the contents present in the sample.

Frequency 2-3 years:

Replacement of the vacuum pump.

Frequency 4-5 years:

Replacement of the HCD (permeation tube) normally performed at the same time as the replacement of the internal mini-purifier as well as the external compact purifier required for nitrogen dosing.

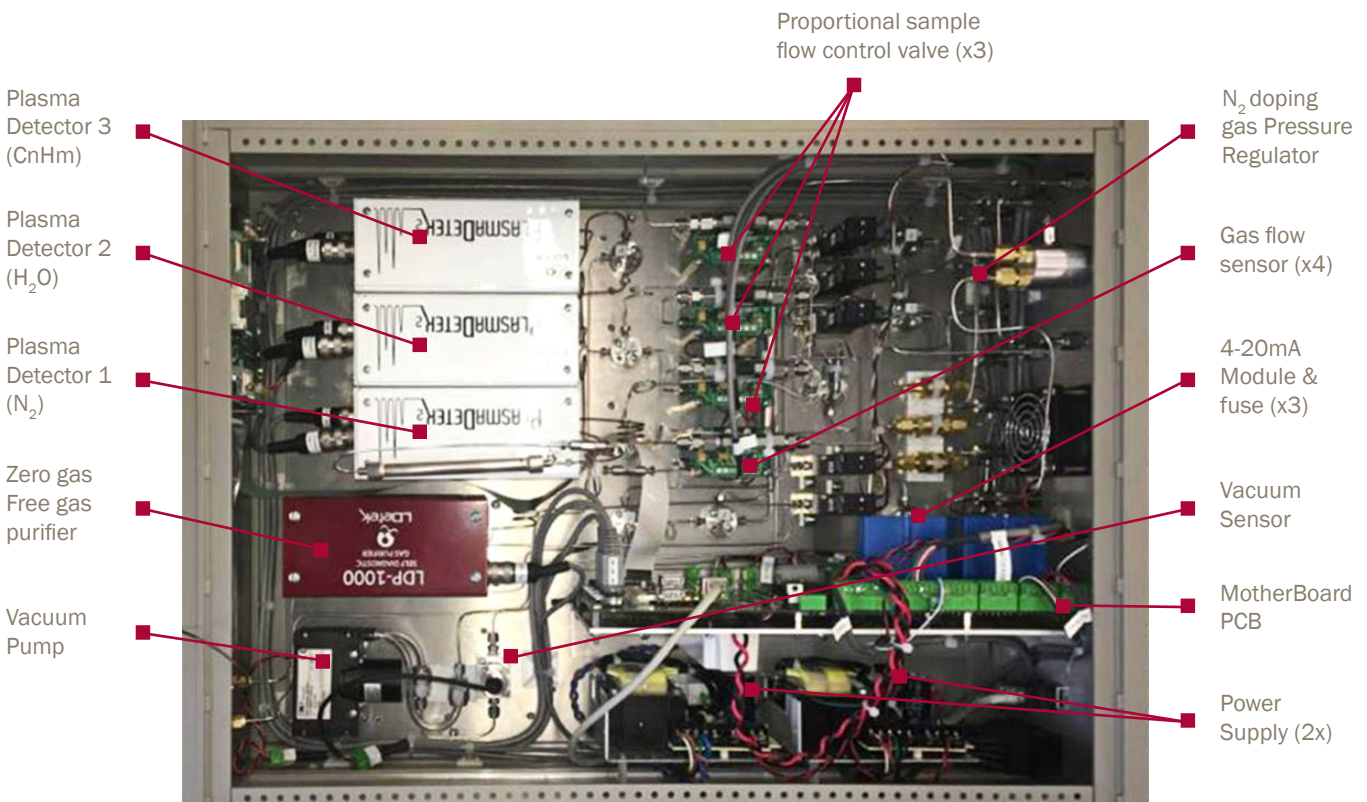

Photo 1

Photo of a configuration based on Figure 1 but for N₂-CnHm-H₂O measurements without O₂ measurement. Other configurations are based on the same mounting but with slightly different module layouts to accommodate the same 4U rack mount cabinet.

Conclusion on the configuration of Figure 1:

This is the most complete configuration of all. It shows no interference between the components to be measured as shown in the table. In addition, this configuration can cover the full range from low ppb / ppm to higher ppm. It is therefore the most robust, stable and precise solution for this type of application.

Figure 2 shows an installation where the required measurement must be configured for the following ranges (low ppm configuration only):

IMPURITIES	N ₂	O ₂	H ₂ O	CnHm
Range	0-10 ppm	0-10 ppm	0-10 ppm	0-10 ppm

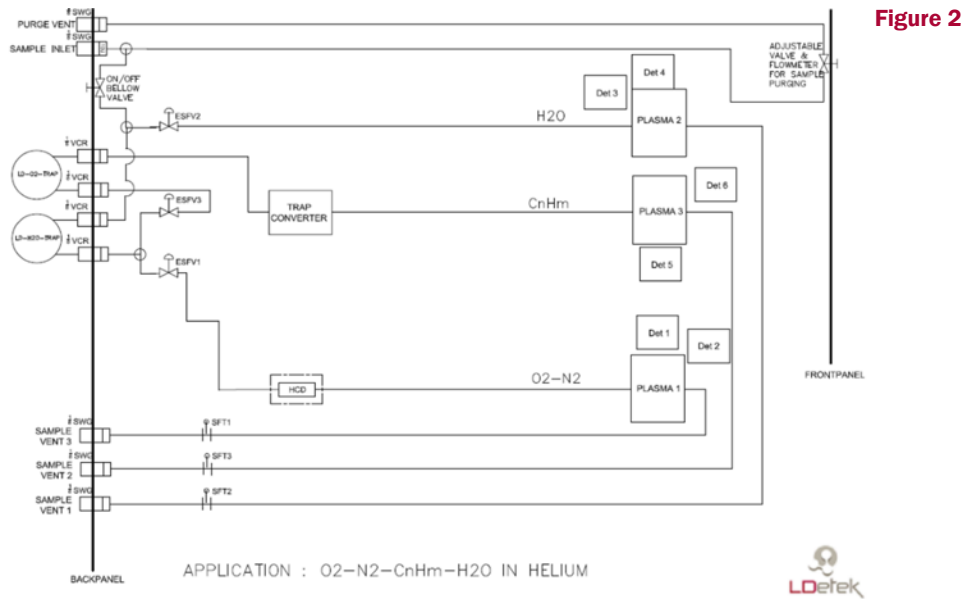

Figure 2 demonstrates an instrument configured as follows:

1. Three plasma detectors have been installed in the instrument, respectively for the N₂ / O₂-H₂O-CnHm measurement. Each detector is configured with a narrow interference optical filter providing an optical response specific to the measured impurity. Each plasma is a monolithic structure made of quartz through which a pipe allows a linear gas flow. Through this linear flow, a scanning by an electric discharge is applied. This discharge is called “dielectric” because these electrodes are mounted externally of the quartz assembly. This ensures the inertia of the block internally being in contact with the gas. The discharge is said to be alternative to a specific high frequency and voltage.
2. Nitrogen doping is not required because the N₂ range is below 10ppm and the interference caused by nitrogen on O₂-CnHm-H₂O measurements is limited.
3. A vacuum pump is not required at the PED output for the same reason as indicated in point 1.
4. Each PED has its own electronic flow control regulated by a proportional microvalve with minimal internal volume. The reading of the flow is made by mass sensors installed at the outlet of the PEDs to avoid any form of contamination and additional volume in front of the detector. Our design allows the use of small flow since no bulky flow control element is installed upstream of the detectors. All tubing is made of 1 / 16”OD stainless steel to minimize purge volumes. A water-repellent “coating” is applied for the plasma pipes used for H₂O measurement to reduce surface absorption. The flow rates at the outlet of each PED are respectively 50 ml / min for a total of 150 ml / min. If this flow rate is combined with the flow rate at the inlet, which is generally adjusted to 100 ml / min, the total flow rate of the instrument is thus 250 ml / min. All this flow can be recovered because it has not been contaminated by the instrument.
5. Moisture interference is removed by installing HCD (H₂O permeation tube) on PED O₂ / N₂. Providing a stable concentration of moisture to the O₂ / N₂ plasma, it is saturated with water, removing the interference caused by moisture in the sample. If the presence of moisture in the sample is above 5-10ppm, then a second trap, this time to capture moisture is required. It consists of molecular sieve 3A and has VCR fittings. When it is not required, a simple “ bypass ” is mounted on the instrument.

6. A software protection system against carbon deposits at the PEDs allows them to go out when the CnHm measurement rises above 3ppm (adjustable parameter). By cutting the excitation of the N2 / O2-H2O PEDs during high CnHm measurements, it is possible to prevent the degradation of the PEDs generally caused by the creation of carbon deposits on the walls of the monolithic quartz block.

7. In this configuration where the plasma nitrogen dosage is not used, it should not be surprising that O2-H2O traps should be used at a lower concentration to eliminate interference than we see in a platform where the nitrogen dosage is in place. This phenomenon is caused by the equilibrium of the species inside the plasma, offering a different mode of operation. It is also for the same reason that in this configuration under Helium plasma only, we use a system of "trap converter" which consists of a mini plasma allowing the carbon to decompose thus allowing the PED CnHm to measure a "by-product" from the carbon decomposition. This allows a more selective measurement of hydrocarbons and at the same time avoids the CnHm PED to make carbon deposits on these walls since the carbons remain in the space of the trap converter system protecting the plasma used to measure the CnHm.

8. In this configuration, each PED contains an additional optical circuit, selective to the N2 measurement. This allows leak diagnosis in each channel.

INTERFERENCE SUPPRESSION SYSTEM:

The protection system of the PEDs in the presence of too high hydrocarbon measurements, combined with O2-H2O trap networks, moisture metering system and carbon converter allows the LD8000-Multigas to minimize the interferences between the impurities. This is a unique LDetek practice, allowing accuracy and prolonged lifetime of the detector.

Table of effects caused by interferences***:

SAMPLE*	10 PPM N ₂ O ₂ CH ₄ H ₂ O	10 PPM N ₂	5 PPM N ₂	4 PPM O ₂	10 PPM N ₂ O ₂ CH ₄
N ₂	10 ppm	10 ppm	5 ppm	-2 ppm** (display = 0 ppm)	10 ppm
O ₂	10 ppm	-3 ppm** (display = 0 ppm)	-2 ppm** (display = 0 ppm)	4 ppm	10 ppm
CnHm	10 ppm	0 ppm	0 ppm	0 ppm	10 ppm
H ₂ O	10 ppm	+0.2 ppm**	+0.1 ppm**	+0.2 ppm**	+0.5 ppm**

* The sample balance is helium

** Approximate measurement based on laboratory tests

*** Other combinations have been successfully tested, so they are not presented in this table. Only critical interference is shown in this table.

MAINTENANCE:

Frequency 12-18 months:

Regeneration of the O2 and H2O traps according to the contents present in the sample.

Frequency 4-5 years:

HCD (permeation tube) replacement.

Conclusion on the configuration of Figure 2:

This is the simplest and cheapest configuration of all, but it presents some interference between the compounds to be measured as shown in the table. On the other hand, these interferences can be negligible according to the needs and the application of the customers.

Figure 3 shows an installation where the required measurement must be configured for the following ranges (so-called low to medium ppm configuration):

IMPURITIES	N ₂	O ₂	H ₂ O	CnHm
Range	0-20 ppm	0-20 ppm	0-20 ppm	0-20 ppm

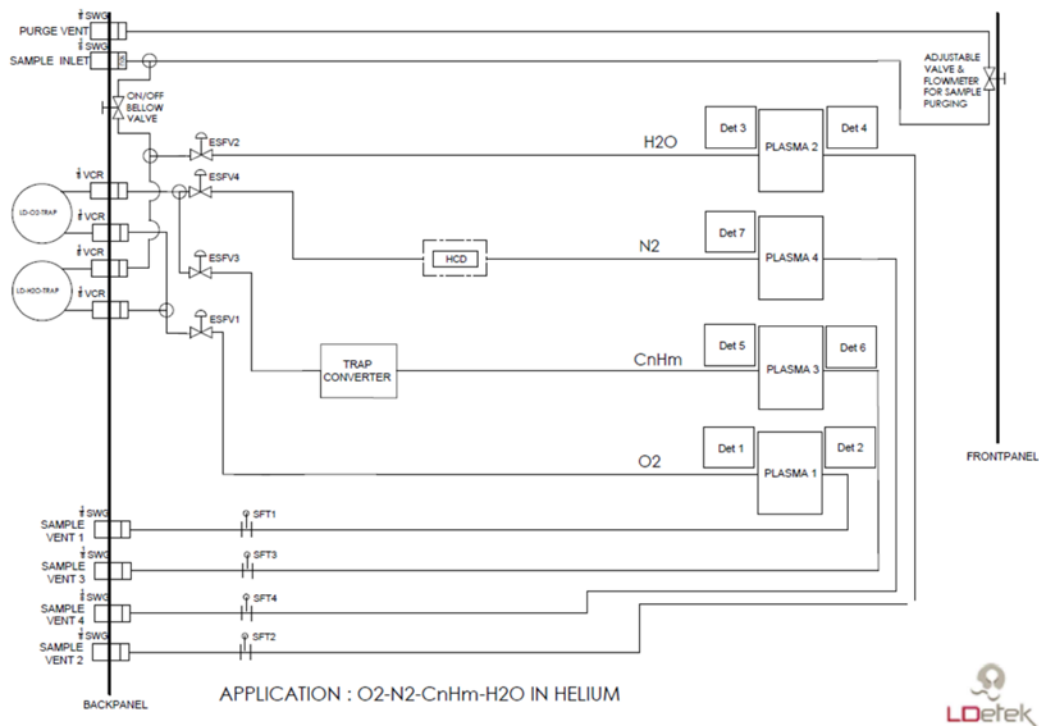

Figure 3

Figure 3 demonstrates an instrument configured as follows:

1. This configuration is similar to the one described in Figure 2. However, it allows to cover a so-called average measurement range, i.e. to go up to 20ppm ranges. To enable this, a plasma specifically configured for N₂ measurement has been added behind the H₂O and O₂ traps allowing to obtain a measurement without interference of nitrogen. In this configuration, the shielded nitrogen measurement is used to apply compensation to the O₂ measurement.

INTERFERENCE SUPPRESSION SYSTEM:

The protection system for PEDs in the presence of excessively high hydrocarbon measurements, combined with O₂-H₂O trap networks, moisture metering system and carbon converter allows the LD8000-Multigas to eliminate interference between the impurities. This is a unique LDetek practice, allowing accuracy and prolonged lifetime of the detector.

Table of effects caused by interferences*:**

SAMPLE*	10 PPM N₂ O₂ CH₄ H₂O	10 PPM N₂	5 PPM N₂	10 PPM O₂	10 PPM N₂ O₂ CH₄
N ₂	10 ppm	10 ppm	5 ppm	0 ppm	10 ppm
O ₂	10 ppm	0 ppm	0 ppm	10 ppm	10 ppm
CnHm	10 ppm	0 ppm	0 ppm	0 ppm	10 ppm
H ₂ O	10 ppm	+0.2 ppm**	+0.1 ppm**	+0.2 ppm**	+0.5 ppm**

* The sample balance is helium

** Approximate measurement based on laboratory tests

*** Other combinations have been successfully tested, so they are not presented in this table. Only critical interference is shown in this table.

MAINTENANCE:

Frequency 12-18 months:

Regeneration of the O₂ and H₂O traps according to the contents present in the sample.

Frequency 4-5 years:

HCD (permeation tube) replacement.

Conclusion on the configuration of Figure 3:

This is the configuration that lies between the simplest and most complete configurations previously explained (Figures 1 and 2). It allows a little higher ranges measurement and interference minimization without the use of nitrogen doping. Depending on the needs and application, this configuration can be considered advantageous and is a good compromise between the two extremes.

DESIGN REPORT

LD20-01



COMPACT STREAM SELECTOR SYSTEM FOR TRACE IMPURITIES ANALYSERS & SENSORS



A quick response time is what is required when its time to talk about gas analysis. Having the right analyser with the proper detection technology is in the scope to be sure the analysis time is short, and the results are stable and accurate. But it is very important to understand that the most critical component when its time to look at the response time and the stability, is the sampling system (also called stream selector system).

OUR SOLUTION

The LDGSS sampling system has been designed for any type of applications when switching from different streams and different calibration gases is required. The system is 19" rackmount (3U size) offering one of the most compact sampling systems available on the market. It can be configured for 3 to 10 streams depending of the requirements. The system has its build in fast loop sample bypass adjustable rotameters mounted on its front side. These rotameters are used to adjust the desired sample bypass purging flow for each of the stream. The scale of these rotameters is changeable depending of the application.

The device can be controlled locally by using the front rotary switch available on the face panel. It can also be controlled remotely by a DCS using the remote contacts available on the back-panel connector.

The flow path has been designed in a way that the sample flow of each stream is in constant purging even if it is not selected to avoid any dead volume (gas pockets) always resulting in response time delay and spikes. Refer to the two diagrams showing the internal flow path configurations.

LDGSS DIAGRAM WITH PNEUMATIC DIAPHRAGM VALVES

The diaphragm valve version is employed here to ensure keeping the air diffusion contamination below 0.1ppb based on the nitrogen impurity at low pressure/low flow rate (a way better than conventional 1×10^{-9} atm cc/sec Helium leak rate). Such design is required when ultra high purity is necessary. The valve is made of 316L stainless steel and have an inert diaphragm that ensure a perfect sealing. The valve actuation pressure required here is 65psig and is regulated by the internal pressure regulator.

An internal purging groove ensure to avoid any risk of air diffusion coming from outboard leakage. That is a critical parameter when low trace impurities are required. All the piping connections in the device are welded to eliminate the risk of contamination. When fittings are required to make a gas connection internally, our LDetek series single ferrule type are used to avoid any miniature pocket of gas generally present when a standard double ferrule is employed. For the external gas connections with the different streams and the analysers, the version face seal (VCR) or compression type can be used in different sizes. A ten microns stainless steel particle filter (frit type) is mounted in each gas connection.

In case the application requires a special attention due to the aggressivity/instability or the absorption of the gas types and impurities measured, a surface treatment can be added to have an inert and less reactive surface. All piping/fittings and valve can be modified with the proper coating and material.

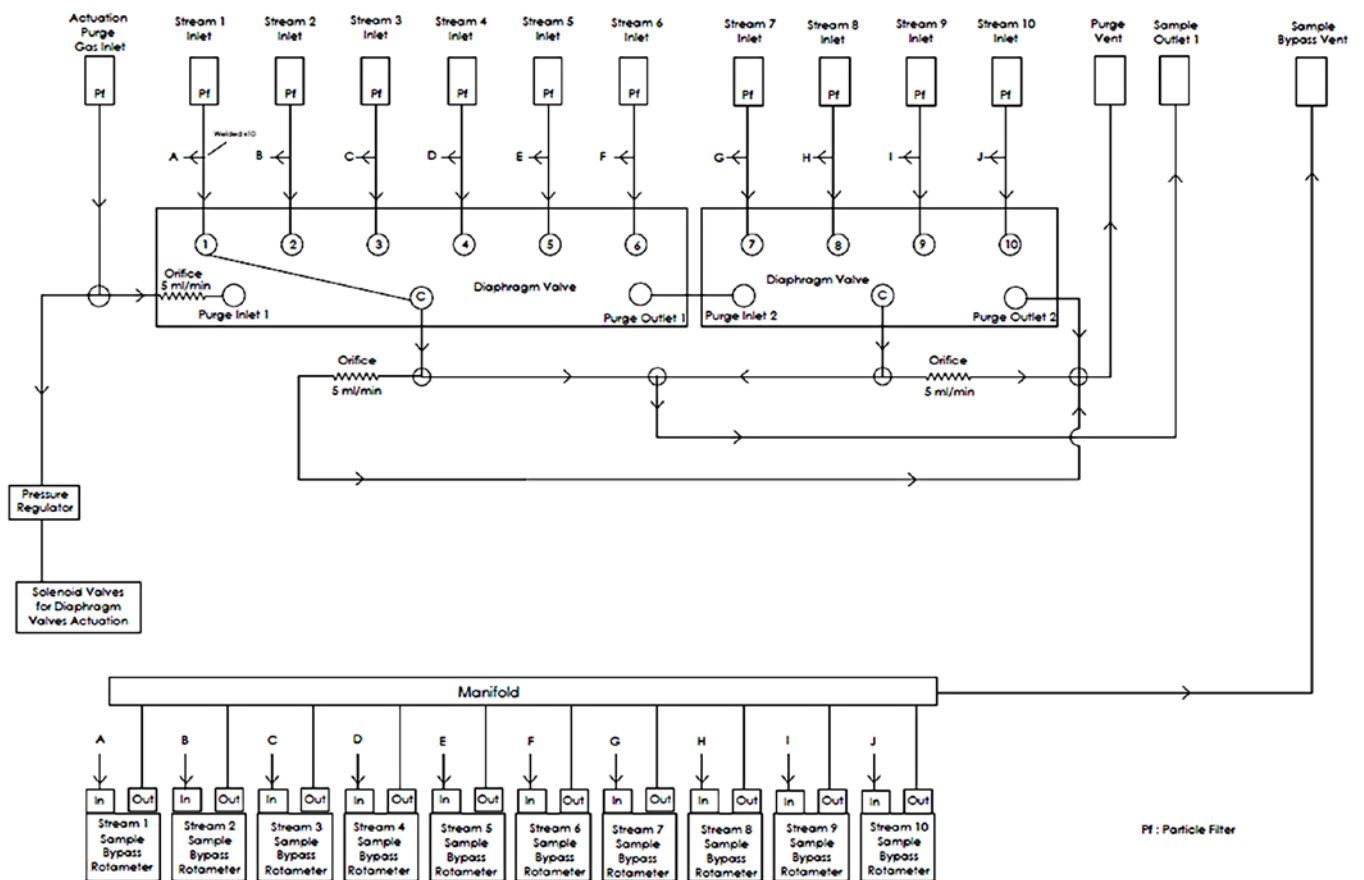

LDGSS DIAGRAM WITH 3 WAYS ELECTRIC SOLENOID VALVES

A generic version of the LDGSSS is available when the limit of detection required for the most present impurities in ambient air like nitrogen and oxygen is over 100ppb. The LDetek, 3 ways solenoid valve offer a Helium leak rate of 1×10^{-9} atm cc/sec. Our leak rate validation methods are the same as the one used for the diaphragm valve series where we used our PlasmaDetek2 patented detector able to measure ppt N₂ in Helium at 200sccm with pressure range being between 2-10psig. Our LDGSS comes with a quality certification where validation of each stream has been performed.

Here again, the unselected streams are in constant purging allowing every stream to be ready for being selected for analysis without having response delay or spike. The purge flow is regulated and maintained by a network of orifices mounted on the normally open port. Such orifice is mounted on each stream for each three ways valve.

The adjustable rotameters play the role of fast purging the gas lines and piping upstream to the unit.

The valve is electric actuated with 12 VDC and is mounted on a 316L stainless steel manifold. The gas connections on the valve manifold are 316L stainless steel 1/16" LDetek single ferrule type. Such fittings eliminate the presence of dead volume.

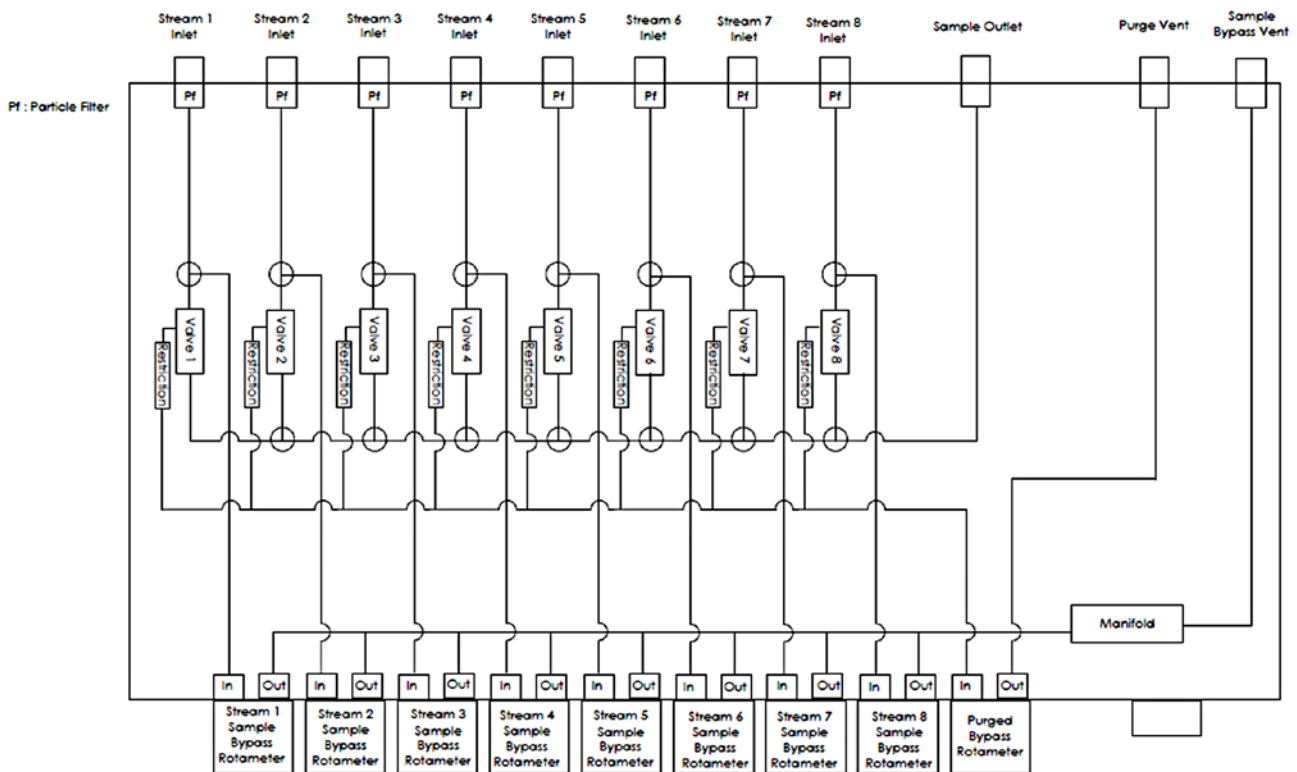

3.0 APPLICATION NOTES

CONNECT UP TO 10 SAMPLE POINTS TO MULTIPLE GAS ANALYSERS AND SENSORS :



...



Trace Oxygen analyzer (GPR & PI2 series)



Trace Moisture analyzer (QMA series)



Gas chromatograph (MultiDetek2 series)



Trace N2 analyzer (LD8000 & LD8000MG series)



Trace THC analyzer (LD2000 series)



O2 sensor (Senz TX series)



Dewpoint sensor (Easidew series) ...

3.0 APPLICATION NOTES

LD8000+

PST
PROCESS SENSING
TECHNOLOGIES

LDetek
A PST BRAND

TRACE SUB PPB/PPT TRACE N2 ANALYSIS IN ARGON OR HELIUM

DESIGN REPORT



3.0 APPLICATION NOTES

The LD8000+ is designed with the plasma emission detector (patented PED) maintained in an optimized controlled vacuum equilibrium to offer an extended collision energy level. The PED arrangement is designed with a valve network that allow to balance between 3 excitation sources. From each of the excitation source, an algorithm measures the PED response delta to convert that signal into a fast and drift free nitrogen reading. This unique design makes the LD8000+ analyser top of the technology to measure trace nitrogen in sub ppb/ppt.

ADVANTAGES OF THE TECHNOLOGY AND ITS DESIGN

- Self canceling effect from gas line contamination & surface absorption
- Fast response time
- Interference free
- Reduce the temperature drifting to minimum value
- Improve the limit of detection down to 0.1ppb trace nitrogen

WORKING CONDITIONS & PERFORMANCES

- Sample pressure: 15-30psig
- Sample gas: Argon or Helium
- Sample gas consumption: 150sccm at 15 psig to 500sccm at 30psig
- Limit of detection (LDL): 0.1ppb Nitrogen
- Stability & Drift: $<+/- 0.01\%$ of the measuring scale
- Repeatability & Accuracy: Greater of $<+/- 1\%$ of the reading or the ldl
- Response time T90: 1 minute

DETECTION PRINCIPLE

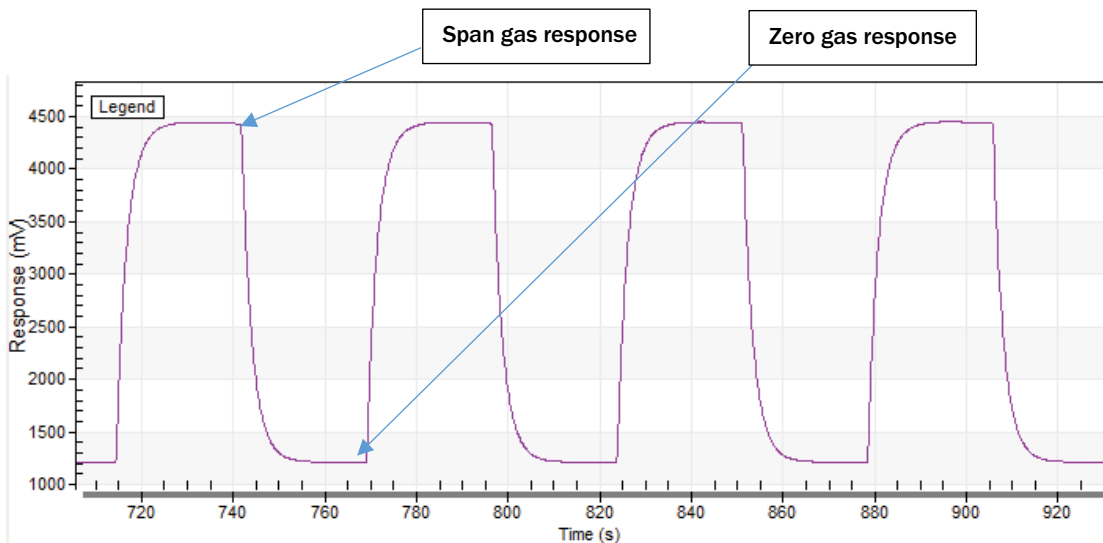

The change in the oscillation is evaluated by switching the gas inside the sensor and by measuring the response delta. For sampling response, the sensor is balanced between a dry gas which is nitrogen free source and the sample source. The difference is then calculated. The same principle is applied for the span gas calibration. However, this time the comparison is between the nitrogen free gas source (zero gas) and a source containing a known nitrogen content (span gas). A cycling time of 30 seconds on each gas is used to compare the response delta.

ANALYSER PERFORMANCE RESULTS

Linearity/Accuracy/Repeatability

The system is fully linear due to the linearization rectification of the sensor. Each system is characterized in function of its full range to ensure the respond is linear. A series of multiple points at different concentration within the scale are performed to achieve a linearization curve having R2 better than 0.99.

The accuracy/repeatability error of the instrument is less than $+/-1\%$ of the reading or its ldl whichever is the higher. In this instance, the table below shows the % deviation for 5 points diluted at different concentrations between 0-1000ppb. For better understanding of the detector response at different concentrations, the raw signal of the algorithm delta calculation from the PED sensor for each of the concentration levels have been included. Each of the figure well represents the response delta between the sample gas and the zero gas. The span calibration performs at 540ppb also appears.

Diluted concentrations (ppb)	Analyser reading (ppb)	Delta (ppb)	Accuracy (% of reading)
1000.0	995.0	-5.0	-0.5
540.0	540.0	0	0
250.0	252.2	+2.2	+0.88
100.0	100.0	0	0
1.0	1.1	+0.1	Ldl 0.1ppb

Sample: 1000ppb Reading: 995.0ppb

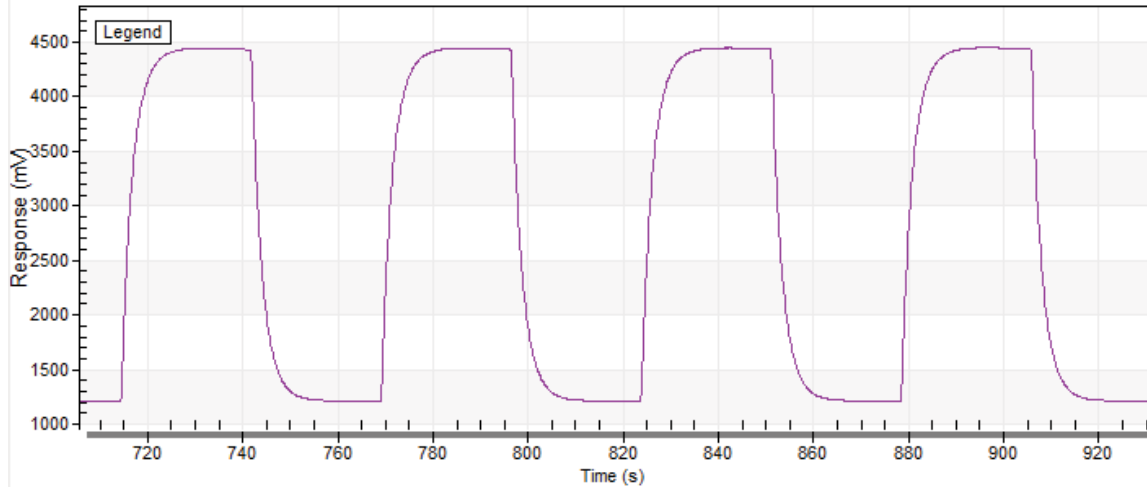

Sample: 540ppb (Span Calibration point)

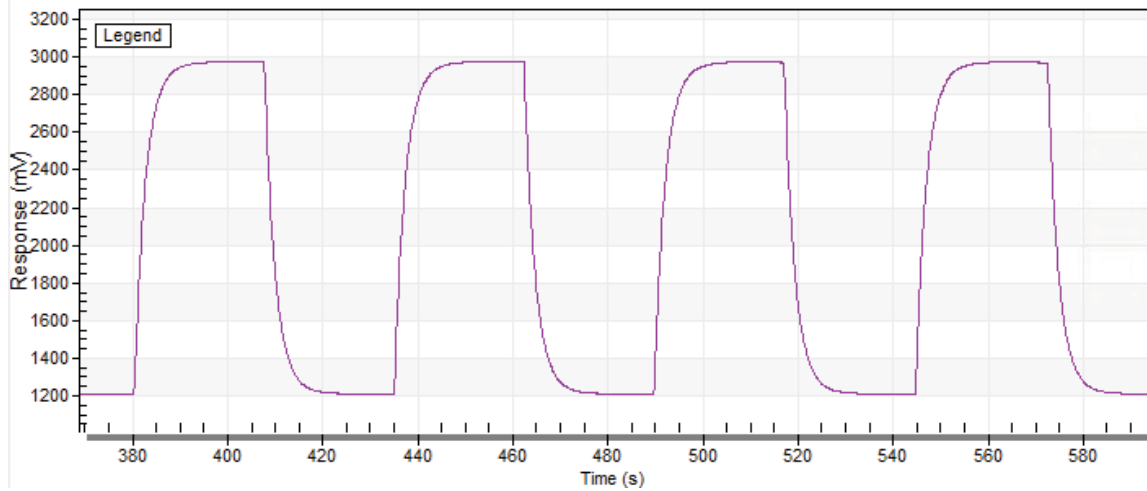

Sample: 250ppb Reading: 252.2ppb

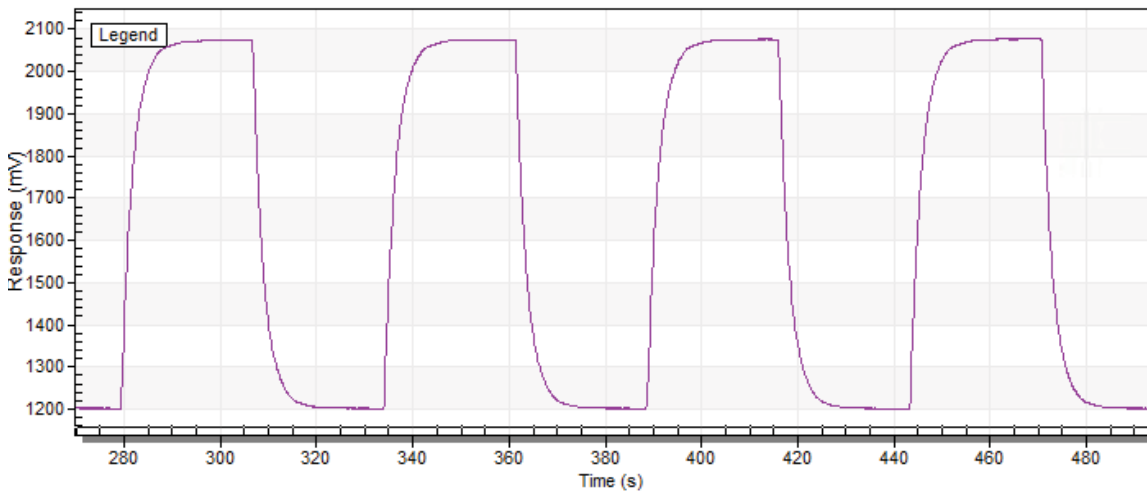

Sample: 100ppb Reading: 100.0ppb

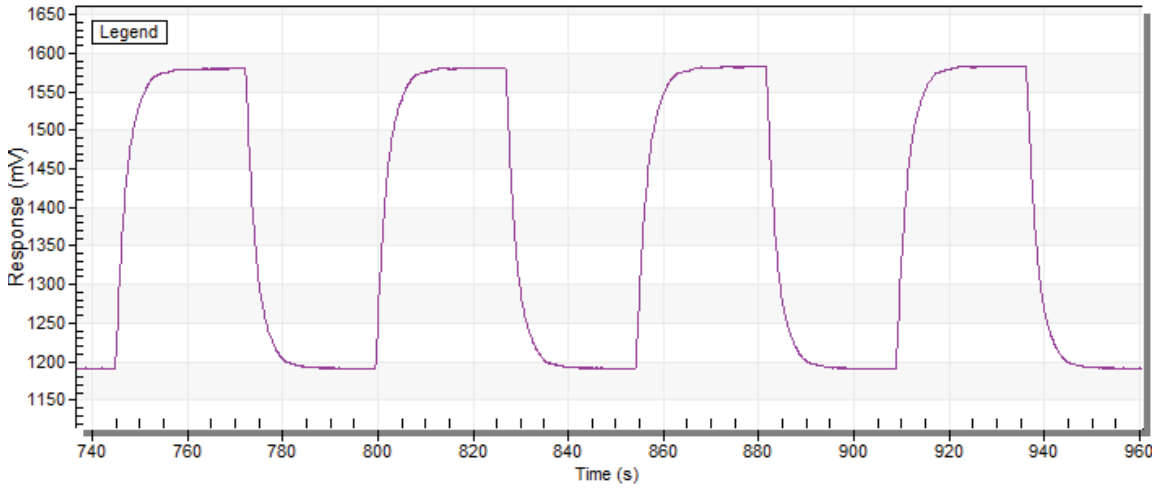

Sample: 1ppb Reading: 1.1ppb

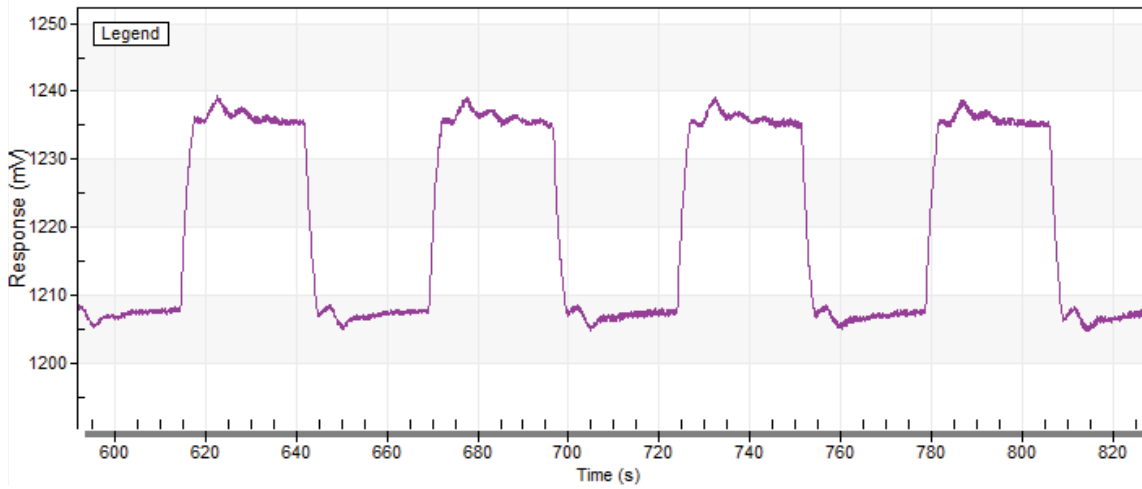

Response Time

Using a dilution system, a series of multiple step changes of 5ppb nitrogen in balance Argon have been performed every 6 minutes. The response time T90 evaluation between every step is about 1 minute in both ways. The same response time apply to both directions (up and down).

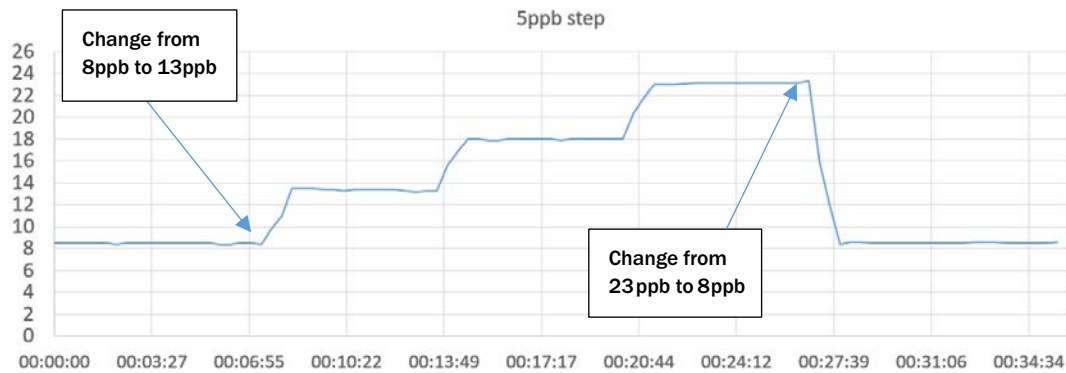

Detection limit (LDL)

Using a 2ppb Nitrogen in Argon gas source, the raw response delta measured by the plasma sensor was 28mV.

The raw signal baseline noise is evaluated at 0.5mV. For instance, the noise level used for the limit of detection is evaluated at 3 times its raw value. Giving 1.5mV.

LDL Calculation:

$(2\text{ppb} * 1.5\text{mV}) / 28\text{mV}$ gives an LDL of 0.1ppb

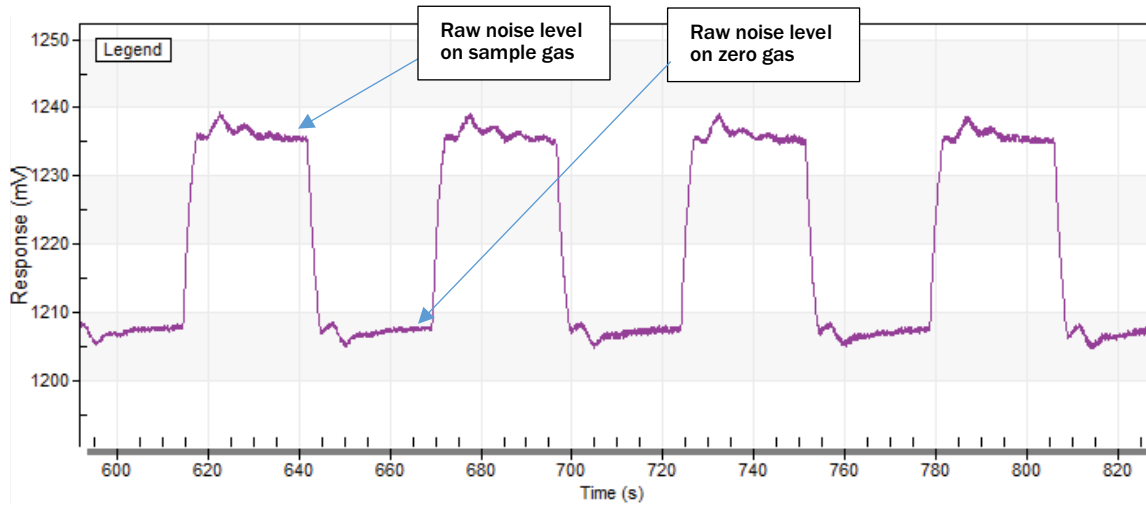

Stability/drift

To evaluate the stability and drift of the unit, a gas source containing 0.5ppb nitrogen in a balance of Argon has been connected as sample gas. The average deviation obtained on a 24-hour period was 0.1ppb while the maximum deviation was 0.2ppb.

Considering an average deviation of 0.1ppb on a measuring scale of 1000ppb, the stability offers by the analyser is better than 0.01%.

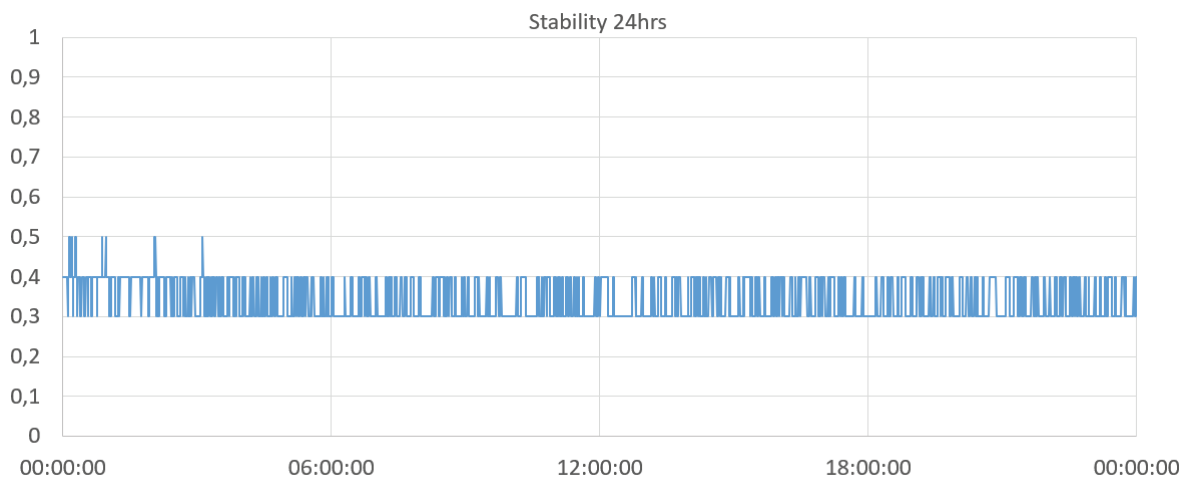

Additional results were obtained to demonstrate the stability of the measurement within a certain temperature deviation. A temperature change of 5 Celsius degree has involved a slight reading variation of 0.3ppb. The test has been repeated with the same range of deviation resulting in a maximum temperature deviation of 0.06ppb per Celsius degree.

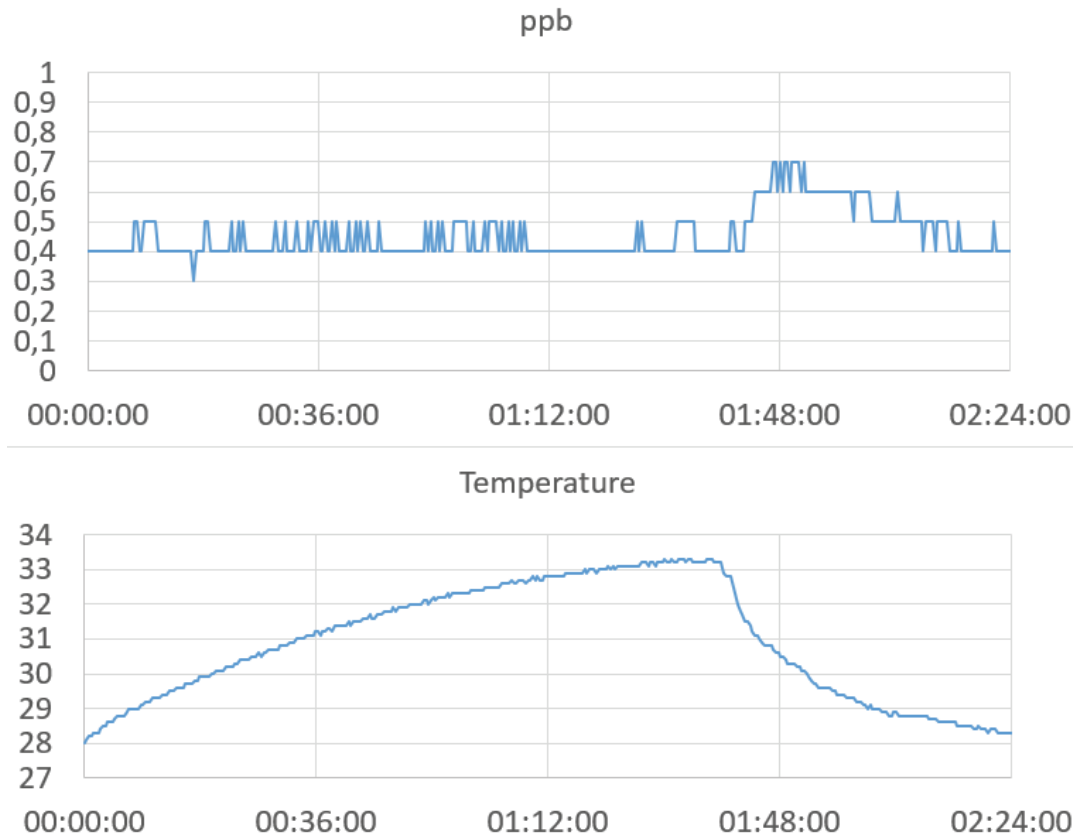

3.0 APPLICATION NOTES

MAINTENANCE

The system is built to be resistant and simple of operation with minimum interventions. A routine maintenance interval every 5 years for replacing the internal gas purifier and the diaphragm of the valve is required. The unit has been designed in a way that replacing those components is very easy.

CONCLUSION

LDetek is proud to offers with its LD8000+ series a high-class rackmount gas analyser configured for measuring sub ppb/ppt trace nitrogen analysis down to 0.1ppb in Argon or Helium.



4.0 TESTIMONIALS





ANALYSIS OF PERMANENT GASES IN DIFFERENT MATRIX USING PLASMADETEK

The goal of this application is to analyze permanent gases in different matrix used for electronic industry. The investigation of these impurities is important for gas providers to ensure the high purity of their products to their customers.

This analyzer has been configured with two independent channels, each one dedicated to one matrix. The system is based on a GC Clarus 580 from Perkin Elmer equipped with electronic pressure regulators. Two high quality 10 ports diaphragm valves with internal purge ensure sample injection directly on-column and matrix backflush. The precolumn is a semi-capillary Plot Q 30m x 530um column. The analytical column is a Molsieve 5A 30m x 530um column with a by-pass flow to elute CO₂. Two detectors Plasmadetek with two internal detectors each are used to quantify the components. The signal coming from each PED is sent to the acquisition software Totalchrom.

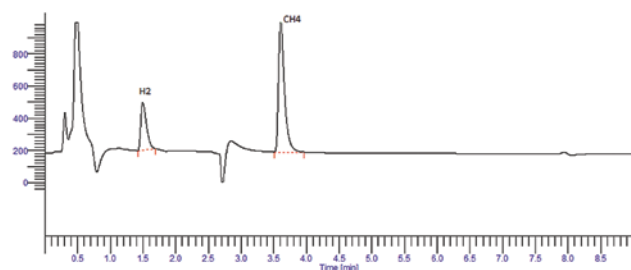

Figure 2

COMPONENT	CONC. (PPM)	PEAK HEIGHT	NOISE	S/N	LOD (PPB) S/N=3	LOQ (PPB) S/N=5
H ₂	5	296	0.02	14800	1.0	1.7
CH ₄	5	808	0.02	40400	0.4	0.6
CO ₂	5	223	0.02	11150	1.3	2.2
N ₂	5	793	0.02	39650	0.4	0.6
CO	5	110	0.02	5500	2.7	4.5

Figure 4

The use of Plasmadetek in this system provides excellent results regarding sensibility and selectivity. The Plasmadetek is ideal for this kind of analyses because it can support high volume of sample injection and we can adjust Make Up gas flow to obtain a suitable chromatogram. The installation of Plasmadetek on a Clarus GC is easy and don't need physical modification of the GC. Its design is in full harmony with the GC whose all parts are accessible for an easy modification (figure 5).

One of the main advantages of Plasmadetek is that it is maintenance free, so that gives a robust system for long analyses sequences in the laboratory or for on-line measuring analyzers. The large range of concentrations (from ppb to %) and the available selectivity of Plasmadetek make this detector ideal to work in a lot of domains where GC is necessary.

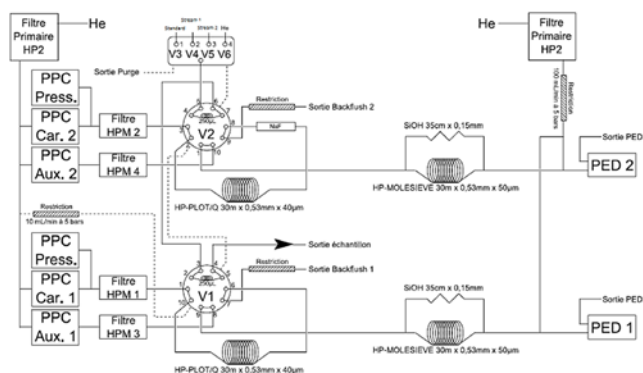

Figure 1

A 5 ppm standard of each permanent gas has been used to calibrate the system and determine LOQ for each component. The chromatograms shown below illustrate the results we can obtain from this configuration. The chromatogram in figure 2 is obtained with the detector optimized for H₂ and CH₄. The chromatogram in figure 3 is obtained with the detector optimized for N₂, CO and CO₂.

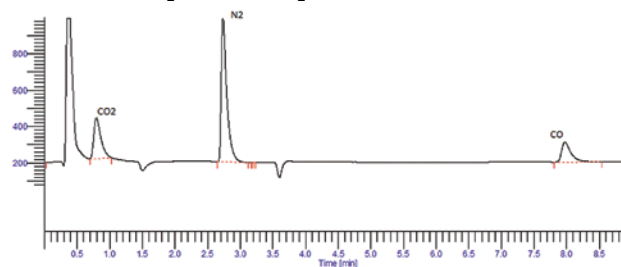

Figure 3



Figure 5

Application: Online analysis of four different streams. Monitoring nitrogen and impurities (H₂, CH₄, HCs, O₂ and CO₂) at low level in Helium matrix with the PlasmaDetek.



Agilent gas chromatograph:
7890A equipped with plasma detector and membrane valves

The online analysis controller software (SRA Prochem) manages and anticipates the selection of the next stream. Alarms are generated when impurities concentration becomes critical. Peak reproducibility using the complete system is close to 1% (RSD; n=5).

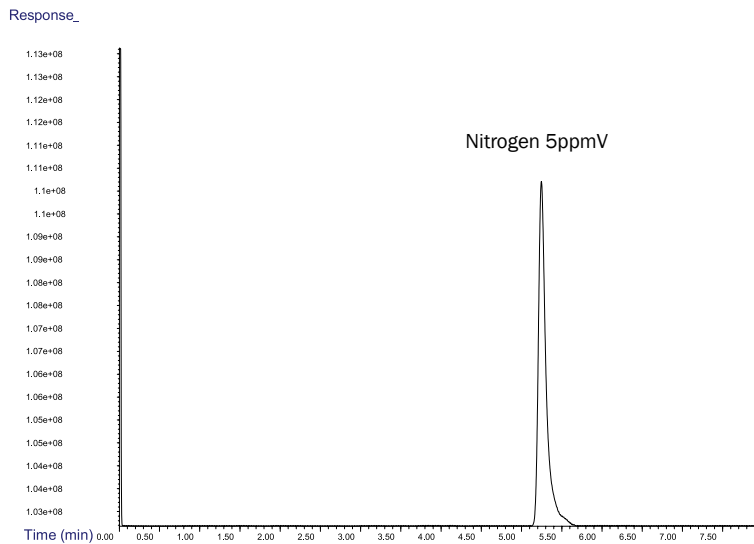

SRAINSTRUMENTS
150 rue des Sources
69280 Marcy l'Etoile
France

T : 04.78.44.29.47
F : 04.78.44.29.62
info@sra-instruments.com
www.sra-instruments.com

SA à Directoire et Conseil de surveillance
au capital de 150.000 €
RCS Lyon B 342 068 731
APE 4669B
SIRET: 342 068 731 00039
Code TVA FR 40342068731



ANALYSIS OF IMPURITIES IN ARGON USING COMPACTGC WITH PLASMADETEK-2

Due to Helium shortage, gas suppliers see an increased request for alternative gases. Their clients demand high purity with exact specification for various applications like instrumental use and industrial production. Often PDD (Pulsed Discharge Detector) is used for measuring impurities in bulk gases. But in case of determining the purity of Argon, separation problems arise with this detector because Helium is used as carrier gas and the bulk Argon elutes close to Oxygen. The Plasmadetek-2 from LDetek offers the perfect solution here, since Argon is used as carrier gas, and therefore the bulk peak is not seen at all.

4.0 TESTIMONIALS

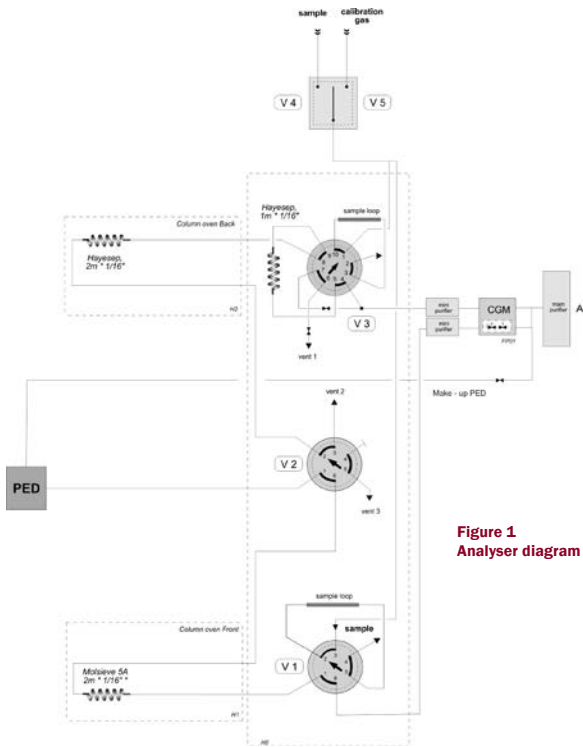

Figure 1
Analyser diagram

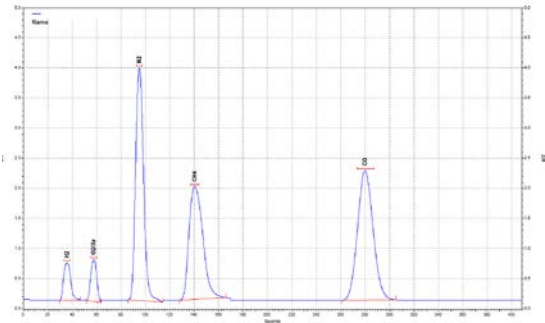

Figure 2
Chromatogram
Molsieve column

Aqilent 35900E Inte...	H2	O2/Ar	N2	CH4	CO
Sample ID	Area	Area	Area	Area	Area
molsieve testFATHel...	203067.00	194281.00	1452795.00	1218724.00	1591571.00
molsieve testFATHel...	202392.00	195591.00	1452917.00	1219249.00	1590896.00
molsieve testFATHel...	205617.00	194085.00	1455726.00	1216440.00	1592798.00
molsieve testFATHel...	204789.00	195496.00	1455690.00	1223070.00	1582777.00
molsieve testFATHel...	205039.00	193859.00	1455817.00	1227535.00	1587183.00
molsieve testFATHel...	205447.00	195147.00	1455831.00	1220549.00	1584348.00
molsieve testFATHel...	205320.00	196256.00	1454897.00	1224674.00	1592919.00
molsieve testFATHel...	203894.00	195299.00	1455741.00	1226357.00	1573995.00
molsieve testFATHel...	206239.00	196406.00	1456723.00	1225968.00	1590468.00
molsieve testFATHel...	205231.00	194874.00	1457012.00	1227555.00	1587986.00
Min:	202392.00	193859.00	1452795.00	1216440.00	1573995.00
Max:	206239.00	196406.00	1457012.00	1227555.00	1592919.00
Mean:	204703.50	195129.40	1455314.90	1223012.10	1587494.10
Std Dev:	1211.05	867.00	1419.98	4022.07	5862.43
%RSD:	0.59	0.44	0.10	0.33	0.37

Figure 3 - Repeatability

Figure 1 shows a two-channel analyser with single Plasma Emission Detector. Valve V1 and Molsieve column analyse H₂, N₂, O₂, CH₄ and CO in Ar. A second channel around valve V3 is present for analysing CH₄, CO₂, N₂O and Ethane in Ar. For analysis of impurities in N₂, a fore-flush column switching option is added to this channel to vent the bulk N₂. Figure 2 shows the Molsieve chromatogram of an 11 ppm calibration standard. Figure 3 demonstrates the obtained repeatability, which is excellent. Valve V2 combines both channels to a single PlasmaDetect-2 detector, which contains up to four optical sensors for optimal sensitivity for each individual component, see figure 4. Figure 5 shows the integrated analyser using CompactGC^{4.0}.

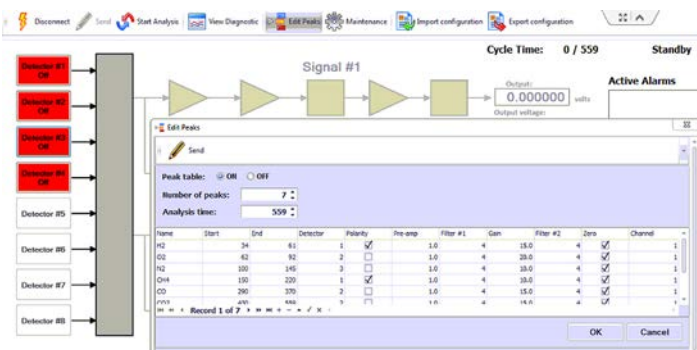

Figure 4 - programming 4 optical sensors in one PlasmaDetect-2 detector



Figure 5 - CompactGC^{4.0}

GLOBAL ANALYSER SOLUTIONS
P.O. Box 2148, 4800 CC Breda, The Netherlands
T: +31 (0)76 5411800 F: +31 (0)842 206757
info@gas-site.com www.gas-site.com



PARTNER

Antelia integrated PlasmaDetek series solutions in many GCs over the last years and is proud of its strong expertise for developing high performance applications. Antelia works with Perkin Elmer lab GC platform to develop their solutions. On top of that, Antelia also integrates PlasmaDetek on the compact GAS GC. Depending on the applications, Antelia uses the GAS compact series or the Perkin Elmer desktop GC.



PlasmaDetek2(PED) mounted on the Clarus Perkin Elmer GC

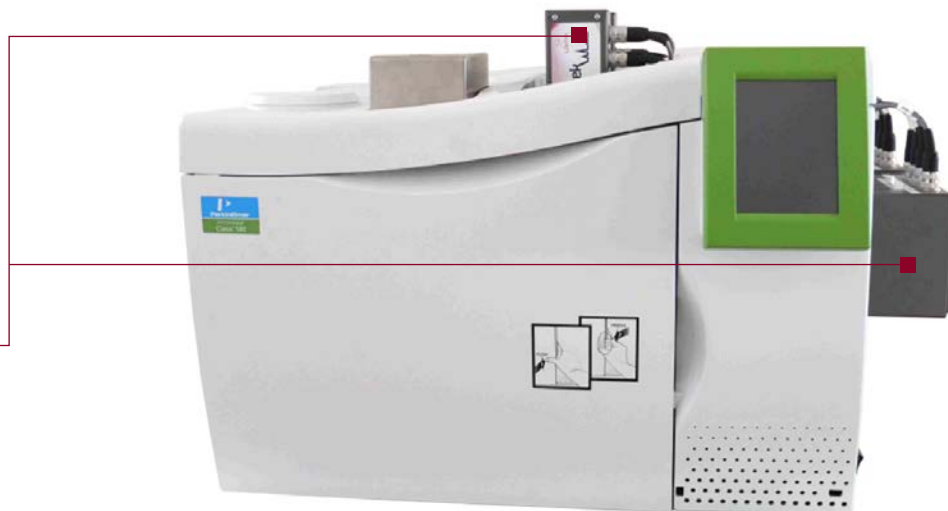

PlasmaDetek1(PED) mounted on the Clarus Perkin Elmer GC

ANTELIA: 9 Chemin de la Brocardière, 69570 DARDILLY • contact@antelia.fr • Port +33 6 77 01 51 25 • Tel +33 4 72 17 82 10 • Fax +33 4 78 66 07 03



CREATVAR
TECHNOLOGY CORP.

ANALYSIS OF TRACE IMPURITIES IN ELECTRONIC GRADE HYDROGEN USING AGILENT GC WITH PDHID AND PLASMADETEK 2

APPLICATION

Impurities(Ar-O2-N2-CH4-CO-CO2) analysis of electronic grade Hydrogen at 10 to 20ppb level with the PDHID and Plasmadetek 2.

This analyzer has been configured with two independent channels, front channel for impurities(Ar-O2-N2-CH4-CO) measurement by PDHID and back channel for impurities(CO2,n-C2~4) measurement by PED . The system is based on a GC 6890N from Agilent equipped with electronic pressure control module. Two low leak rate 6 port and 4 port switching valves with Molsieve 5A column to perform bulk Hydrogen heart-cut technic and assure the baseline separation for Ar and O2 in H2 gas sample.

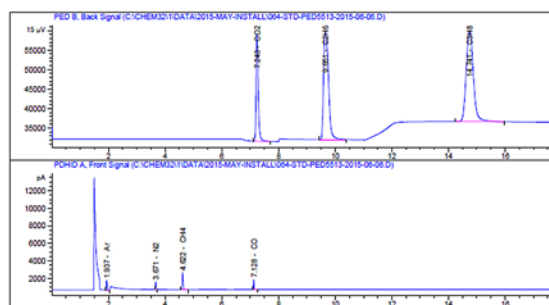
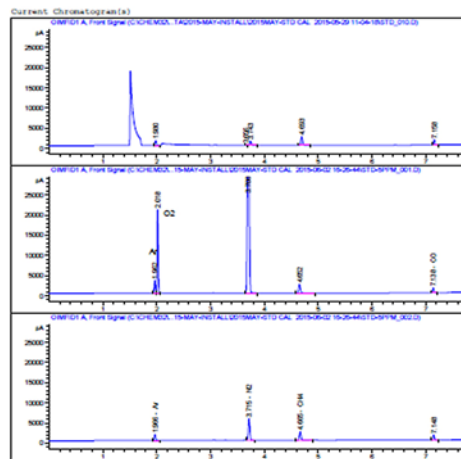

Signal 1: PED B, Back Signal

RetTime [min]	Type	Area [15 μV*s]	Amt/Area	Amount [ppm]	Grp	Name
7.243	BB S	1.44087e5	2.78998e-5	4.02000	CO2	
9.651	BB S	3.36276e5	3.28599e-5	11.05000	C2H6	
14.741	BB	4.07393e5	1.13159e-5	4.61000	C3H8	

Signal 2: PDHID A, Front Signal

RetTime [min]	Type	Area [pA*s]	Amt/Area	Amount [ppm]	Grp	Name
1.937	BBA	1860.75464	2.86443e-3	5.33000	Ar	
3.671	BB	1753.38501	3.59305e-3	6.30000	N2	
4.622	BB	4349.97461	1.13334e-3	4.93000	CH4	
7.128	BB	1978.74536	2.41567e-3	4.78000	CO	

LDL CALCULATION				
COMPONENT	Standard Gas Conc. (ppm)	Peak Height	3xNoise	MDL (ppb)
AR-PDDA	5.33	1826.99624	0.3381	9.36858
N2-PDDA	6.3	794.99384	0.3381	2.679304
CH4-PDDA	4.93	1911.48582	0.3381	8.72009
CO-PDDA	4.78	1107.18896	0.3381	1.45966
CO2-PEDB	4.02	19544.75508	6.4824	1.33331
C2H6-PEDB	11.05	16159.39258	6.4824	4.43275
C3H8-PEDB	4.61	15624.92695	6.4824	1.91258



Copyright (C) 2008 CREATVAR TECHNOLOGY ALL Right Reserved
 地址:807 高雄市三民區北平二街10號7F
 Tel:07-3150125 Fax:07-3150025
 www.cvtweb.com.tw



PLASMADETEK2 (PED) MOUNTED ON DANI MASTER GC

APPLICATION SUMMARY

At Microbial Analytics Sweden AB we have investigated gases dissolved in water for over two decades. The water is collected from deep boreholes in solid rock and the gases are dissolved in the water under very high pressure. The background is that some of these gases might act as fuel for microorganisms; other gases indicate ongoing microbiological processes. It is important to investigate these mechanisms because they might endanger long-term storage of for instance spent nuclear fuel. Also, in a shorter time span other structures underground might be heavily corroded by such mechanisms.

SOLUTION

We have developed our own sampler design to collect and transfer the water pressurized to the laboratory. After extraction, we analyze the dissolved gases using several different gas chromatographs. The ranges of gases are the usual permanent gases, though present at unusual ratios and concentrations, as well as lighter hydrocarbons.

As a research institute it is important for us to keep the quality at a very high level. Because of this we have decided that all analytical results should be verified by multiple analyses on different gas chromatographs using alternative columns as well as alternative principles of detection.

Last year we decided to replace an older gas chromatograph that was set up with TCD detector as well as an FID detector and a methanizer. It was brought to our attention by the Swedish agent for PlasmaDetek2, Kovalent AB, that the plasma detector could be a useful alternative for the replacement instrument. Because of this we settled for the PlasmaDetek2 instead of the FID/methanizer setup on one channel in the new chromatograph, keeping TCD detection on the other channel.

For us this was a very fortunate decision since the PlasmaDetek2 has qualities difficult to obtain in other ways. Not only is it very easy to quantify carbon monoxide and

dioxide in the same run as the hydrocarbons without the need for a methanizer that has to be protected by switching valves. It is also possible to detect inert permanent gases in the same run. This is very much in line with our quality goals, to detect the analytes using different principles. Other instruments in our laboratory are still equipped with for instance FID detection and the results are compared, showing very good correlation.

Another positive effect was the ability to tune the sensitivity for different gases. In our samples we sometimes have to measure hydrogen at low concentration in the presence of comparatively high levels of neon. Chromatographic separation is possible, but not always optimal. Using the PlasmaDetek2, the sensitivity for hydrogen is much higher than for neon and the quantification gets a lot easier.

The PlasmaDetek2 (PED) detector has been a very positive experience for us!

RESULTS

The chromatogram below shows an example of analysis of a sample gas containing 0,10% of CO-CO₂-C₂H₂-C₂H₄-C₂H₆ and C₃ in balance nitrogen. The CH₄ is also measured in this application and the integration window appears at minute 5, but it is not present in the sample gas used for this analysis.

On the chromatogram, we can see that the CO peak is integrated in a slight drift that comes from the balance Nitrogen peak that elutes just before. The selectivity of the PlasmaDetek2 (PED) for the CO measurement makes it suitable to measure it, even if the column used cannot separate N₂ from CO perfectly.

The C₂'s are also shown in a slight drift that comes from the temperature programming of the column. The peaks can be separated and integrated with success at any concentration.

The configuration of the system uses a single Carboxen 1010 column for the separation. The column temperature was programmed to allow the peaks having a late elution time to come earlier. The injection volume used was 100 micro liters.

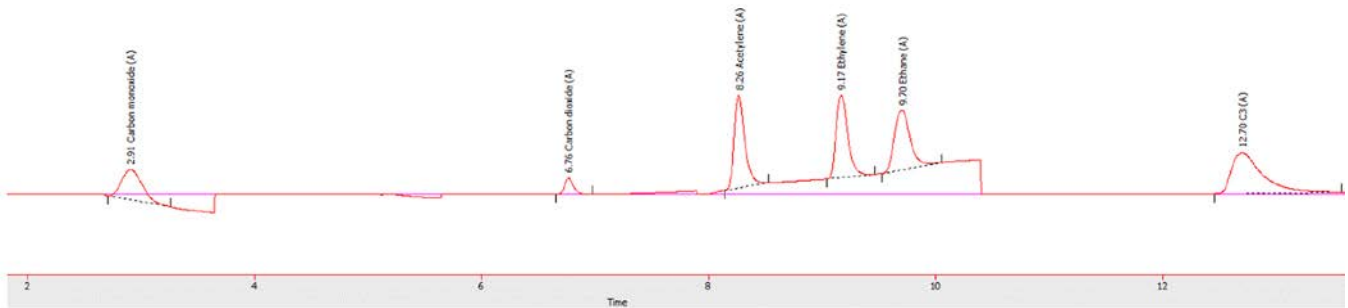

SYSTEM PICTURE

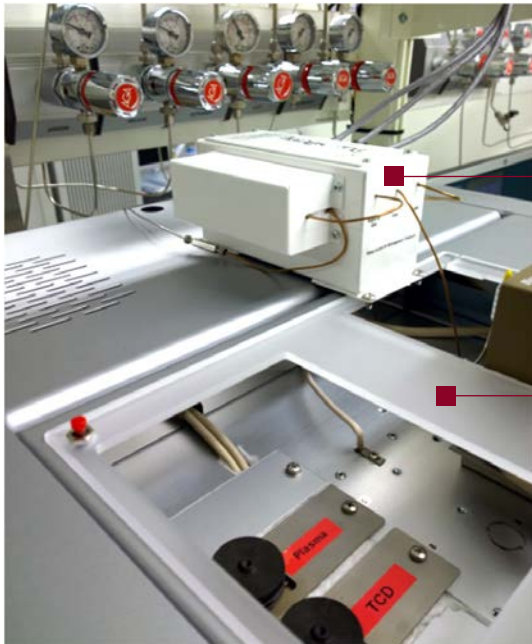

PlasmaDetek 2 (PED)



DANI Master GC

Koalent AB, Fältspatsgatan 6, 421 30 Västra Frölunda. Tel. +46 (0)31 709 81 80, e-post: koalent@koalent.se

APPLICATION SUMMARY

As part of a research project for measuring greenhouse gases in France, more precisely for the N2O and CO2 for multiple soil sample analysis having a wide range of concentrations, the use of the PlasmaDetek2 (PED) detector and the Agilent 7890 GC combined with the Headspace 111 auto sampler system have been used in this proposed solution.

CHALLENGE OF THE APPLICATION

The samples from different locations come in 40ml vials. More than 4000 samples have to be analyzed per campaign. The samples contain CO2 concentrations ranging from 500ppm up to 80% and N2O concentration from 300ppb up to 5000ppm. The system of detection must be able to cover each sample within 15 minute cycle time. Low and high concentrations are analyzed with the same system.

SOLUTION

System implementation comprises a Headspace setter 111 positions coupled to an Agilent 7890 gas chromatograph (GC) equipped with purged valves and connected to two types of detectors, one TCD for high levels of CO2 in particular, and a PED (PlasmaDetek2 from LDetek) for traces of N2O. The advantage of this notorious PED detector with respect to ECD detector, frequently encountered in this application, is the absence of radioactive source subject to a heavy administrative procedure and staff empowerment. The presence of these two sensors in the same instrument, allows analysis and quantification of high levels of CO2 and very low levels of N2O.

SYSTEM PICTURE



RESULTS

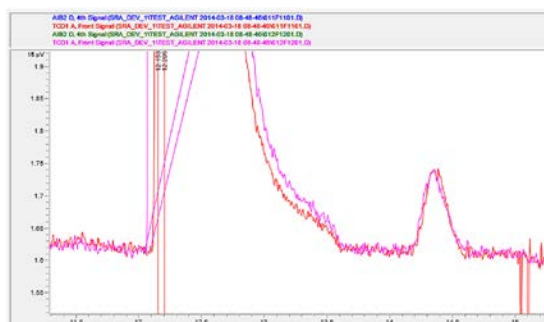

Chromatogram showing 80% CO2 and 40ppm N2O using TCD channel. This channel gives the ability to measure high concentration CO2.

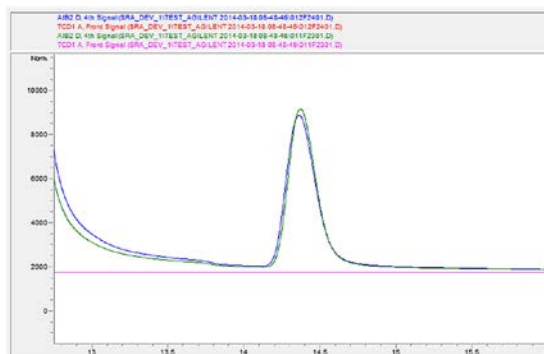

Chromatogram showing 40ppm N2O using PED (PlasmaDetek2) channel. This channel is used for measuring low concentration N2O.

SRAINSTRUMENTS
150 rue des Sources
69280 Marcy l'Etoile
France

T : 04.78.44.29.47
F : 04.78.44.29.62
info@sra-instruments.com
www.sra-instruments.com

SA à Directoire et Conseil de surveillance au capital de 150.000 €
RCS Lyon B 342 068 731
APE 4669B
SIRET: 342 068 731 00039
Code TVA FR 40342068731



Hydrogenics is a leading developer and manufacturer of hydrogen generation and hydrogen-based power systems. With a proven track-record of over 60-years of experience in fuel cell technology and innovation.

Hydrogenics helps companies reduce their footprint by reducing carbon emissions and producing clean renewable energy that can be sent back into the power grid. Hydrogenics super-dense PEM fuel cell allows for large-scale energy storage with unprecedented high-overload capability.

SOLUTION

The 1 MW pilot plant in Daesan Korea produces renewable electricity from unclean hydrogen and sends it back to the Korean power grid to be used for home and industry. Hydrogenics needed a company that offered advanced quality critical monitoring system and LDetek delivered with its turnkey solution cabinet system. The MultiDetek 2 checks the level of purity to ensure no contaminants in the hydrogen stream being delivered to the PEM fuel cell. LDetek provided a full system including cabinet, LDGSS (streams selector) and carrier gas purifier. As a company that values safety and reliability, Hydrogenics only chooses best-in-class partners, making LDetek an ideal choice to do business with.

INSTALLATION PICTURES

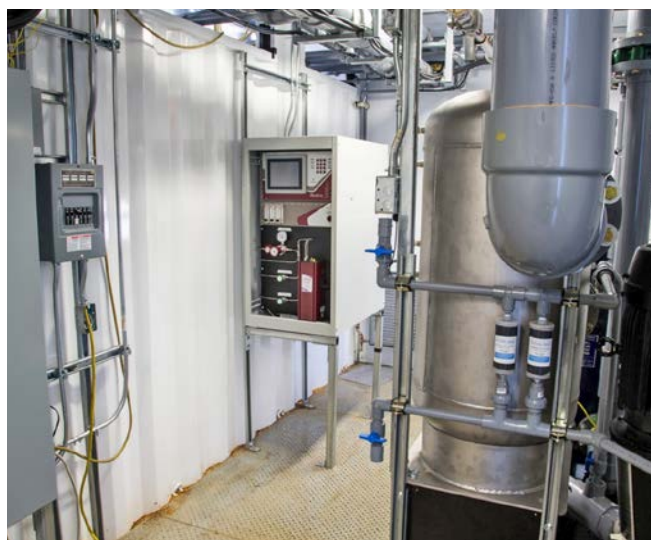

WWW.HYDROGENICS.COM

doi : 10.3969/j.issn.1008-6145.2016.01.023

等离子体发射检测器在检测高纯氦气中 微量氖气的应用*

胡树国, 张体强

(中国计量科学研究院, 北京 100029)

摘要 采用等离子体发射检测器 (PED) 和氦离子放电检测器 (DID) 对重量法制备的氦气中微量氖气进行了检测, 对比了微量氖气在两种检测器上的灵敏度和重复性。结果显示, PED 对氖气的检测灵敏度较高, 氖气含量在 0.03~0.3 $\mu\text{mol/mol}$ 范围与响应值呈良好的线性关系, $r^2=1.000$, 检测限小于 1 nmol/mol , 测定结果的相对偏差小于 2% ($n=6$)。利用大气压离子质谱仪对检测限测试结果进行了验证。采用等离子体发射检测器检测氦气中微量氖气的方法, 可以降低微量氖气标准物质的定值不确定度, 为研制高准确度微量氖气标准物质奠定基础。

关键词 等离子体发射检测器; 高纯氦气; 微量氖气; 检测限; 气体标准物质

中图分类号: O657.3

文献标识码: A

文章编号: 1008-6145(2016)01-0078-03

Application of Plasma Emission Detector in Determination of Trace Neon in High Purity Helium

Hu Shuguo, Zhang Tiqiang

(National Institute of Metrology, Beijing 100029, China)

Abstract Trace neon in helium prepared by gravimetric method was determined by gas chromatography with plasma emission detector and discharge ionization detector. Sensitivity and repeatability of trace neon in different detector were compared. The results showed that the detection sensitivity of PED was higher, the linear range of neon was 0.03~0.3 $\mu\text{mol/mol}$, the correlation coefficients (r^2) was 1.000, the detection limit was less than 1 nmol/mol , the RSD was less than 2% ($n=6$). By comparing the data of atmosphere pressure ion mass spectrometry, the reliability of the results was verified. The determination of trace neon in helium by plasma emission detector may decrease the uncertainty of neon reference material, which lays the foundation of development of high precision trace neon standard material.

Keywords plasma emission detector; high purity helium; trace neon; detection limit; gas standard material

氦气是主要的工业气体品种之一, 被广泛应用于军工、科研、石化、制冷、医疗、半导体、管道检漏、超导实验、金属制造、深海潜水、高精度焊接、光电子产品生产等。在实验室中, 氦气主要作为气相色谱仪、气体质谱仪等仪器的载气使用。在氦气应用领域中, 使用者对其纯度有着较高的要求, 氦气中杂质检测是判断氦气纯度的重要手段。国标 GB/T 4844-2011^[1] 中给出了 4 种不同纯度氦气中氖气、氢气、氩气、氧气、氮气、一氧化碳、二氧化碳、甲烷和水分共 9 种杂质含量的指标, 并建议除水分外, 其它 8 种组分可以利用氦放电离子化色谱法测定。在这 8 种杂质中, 氖气是比较特殊的一种气体, 通常不能通过纯化方法去除; 此外, 氖气电离能较高, 在氦离子放电色谱仪上的响应值低, 检测灵敏度不高, 在有些检测器仪器上, 甚至没有响应信号。

在研制高准确度氦气中微量氖气标准物质过程中, 需要准确定量高纯氦气中微量氖气, 氖气的检测限及其不确定度对标准物质的定值有很大影响, 因此选择合适的仪器定量检测氖气以及确定仪器的检测限是研制标准物质的关键。

蔡体杰^[2] 等对微量氖气的检测方法进行了总结。笔者实验室有两台不同原理的放电离子化色谱仪, 一台为放电离子化色谱仪 (检测器为氦离子放电检测器, DID), 另一台为脉冲放电氦离子化色谱仪 (检测器为脉冲放电氦离子检测器, PDHID)。配有 DID^[3] 或 PDHID^[4-5] 检测器的气相色谱仪主要用于高纯气体中杂质的分析和检测, 在标准物质研制及气体分析等领域有着广泛应用。通过使用两台

* 国家支撑计划项目 (2013BAK10B03)

联系人: 胡树国; E-mail: hushg@nm.ac.cn

收稿日期: 2015-10-20

色谱仪对微量氖气的检测发现,配有 DID 的色谱仪可以检测到高纯氦气中的氖气,而配有 PDHID 的色谱仪对氖气没有响应,这与文献中报道一致^[3]。除了上述常见的 DID 外,目前新购置了一台配有等离子体发射检测器 (PED) 的气相色谱仪。PED 是一种新型色谱检测器,其原理是在检测器的石英小池周围加以高频、高强度的电磁场,在高频、高强电磁场的作用下载气和杂质气体被电离为等离子体,等离子体具有较高的能量,样品进入检测器的石英小池之后,被等离子体电离并发出不同波长的光,主组分发出的光不能通过被检测组分的滤光片,这样就避免了主组分的干扰,光信号经光电二极管转化为电信号,因此 PED 检测器是一种选择性光谱检测器^[6]。

笔者利用配有 DID 和 PED 的气相色谱仪对重量法制备的 3 瓶氦气中微量氖气混合气进行了分析比较,结果发现 PED 对氖气的检测灵敏度较高。利用 3 瓶混合气的重量值和在 PED 上的响应值进行线性拟合,得到了微量氖气在 PED 上的检出限,并计算出检出限的不确定度。

1 实验部分

1.1 主要仪器与气体

氦放电离子色谱仪:592 型,美国 GOW-MAC 公司;

等离子体发射色谱仪: MULTIDETEK2 型,美国 LDetek 公司;

大气压离子质谱仪:APIX 8 Q 型,美国 Thermo Fisher 公司;

高纯氦气:纯度大于 99.999%,北京氦普北分工业气体有限公司;

高纯氖气:纯度大于 99.999%,北京首钢氧气厂;

氦气中微量氖气混合气体:氖气含量分别为 0.276 $\mu\text{mol}/\text{mol}$ (L0054012[#] 瓶), 0.101 $\mu\text{mol}/\text{mol}$ (305593[#] 瓶), 0.028 $\mu\text{mol}/\text{mol}$ (L0054174[#] 瓶)。

1.2 仪器工作条件

1.2.1 DID 色谱仪

色谱柱: 13X 分子筛柱 (3 m \times 3.2 mm); 柱温: 80 $^{\circ}\text{C}$; 检测器温度: 室温; 放电电压: 300 V。

1.2.2 PED 色谱仪

色谱柱: Argotek 柱 (2.4 m \times 3.2 mm); 柱温: 45 $^{\circ}\text{C}$; 检测器温度: 60 $^{\circ}\text{C}$; 增益值: 10。

1.2.3 大气压离子质谱仪

选择离子: 20; 放电电压: 1 200 V。

2 结果与讨论

2.1 氖气在 DID 和 FED 上响应比试验

选用同一瓶高纯氦气根据重量法原理^[7]利用微量转移技术^[8-9]制备 3 瓶氦气中氖气,瓶号为 L0054174[#] (0.028 $\mu\text{mol}/\text{mol}$), 305593[#] (0.101 $\mu\text{mol}/\text{mol}$), L0054012[#] (0.276 $\mu\text{mol}/\text{mol}$)。分别采用 DID 检测器和 PED 检测器对稀释气 (高纯氦) 和制备的 3 瓶混合气进行分析,结果见表 1。

表 1 稀释气和 3 瓶混合气中氖气在 DID 和 PED 上的响应 ($n=6$)

气体	DID		PED	
	响应值/ (mV·s)	RSD/ %	响应值/ (mV·s)	RSD/ %
稀释气 (高纯氦气)	0	—	0	—
L0054174 [#] 混合气	0	—	381.8	2.0
305593 [#] 混合气	158.1	4	1 390.2	0.5
L0054012 [#] 混合气	347.5	3	3 839.6	0.5

由表 1 可知,对于 0.1 $\mu\text{mol}/\text{mol}$ 以上的微量氖气在 DID 和 PED 检测器上均有响应;当氖气含量下降至 0.03 $\mu\text{mol}/\text{mol}$ 时,在 DID 检测器上没有响应,而在 PED 检测器上响应值仍较高,如图 1 所示。



图 1 含量为 0.03 $\mu\text{mol}/\text{mol}$ 氖气在 PED 上的响应

2.2 线性方程

对于 DID 检测器,由于低含量氖气混合气在 DID 上没有响应,无法获得线性方程。利用表 1 中 PED 对混合气体的检测数据,以氖气的含量 (X , $\mu\text{mol}/\text{mol}$) 为横坐标,以响应值 (Y) 为纵坐标进行线性回归,得回归方程为 $Y=13\,952.3419X-13.029\,0$, $r^2=1.000$ 。

2.3 检测器的重复性

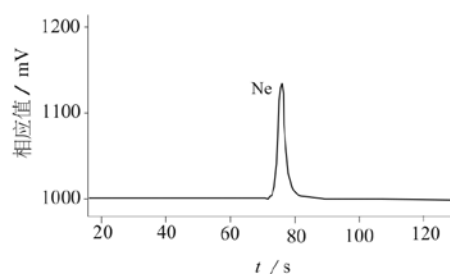
从表 1 可以看出,随着氦气中氖气含量的降低,氖气在 DID 和 PED 上响应值的相对标准偏差逐渐增大。氖气在 DID 检测器上相应值的相对标准偏差明显大于 PED 检测器。原因可能是 DID 检测器需要通过提高放电电压才能实现检测氖气,而提高放电电压将增大基线噪声;另一方面,低含量的氖气在 DID 上的响应值较小,从而导致重复性变差。PED 检测器具有较高的灵敏度,氖气含量大于 0.1 $\mu\text{mol}/\text{mol}$ 时,其 6 次进样测定结果的相对标准偏

差为 0.5% ; 氦气含量低于 $0.1 \mu\text{mol/mol}$ 时, 相对标准偏差为 2.0%。

2.4 PED 检测限的确定

用于制备微量氦气混合气的稀释气(高纯氦气)在 PED 检测器上没有响应, 说明稀释气中的氦气含量低于 PED 仪器的检测限。当仪器响应值为零 ($Y=0$) 时, 可通过拟合的方程计算出 X 值为 0.93 nmol/mol , 由此推断氦气在 PED 上的检测限为 1 nmol/mol 左右。根据文献方法^[10] 计算得检测限的标准不确定度为 0.51 nmol/mol 。

为进一步验证数据的准确性和可靠性, 利用高灵敏度高的大气压离子质谱仪^[11-12] 对结果进行了核验, 测试结果显示, 稀释气中氦气杂质含量小于 1 nmol/mol , 这与 PED 检测器上得出的结论相一致。根据 PED 测试结果, 可以给出用于制备 3 瓶混合气体的稀释气中氦气的含量小于 1 nmol/mol , 考虑到还有其它因素的影响, 将 PED 对氦气检测限的不确定度扩大为 1 nmol/mol 。

假设研制 $1 \mu\text{mol/mol}$ 的微量氦气标准物质, 如果以 DID 色谱仪对稀释气中的氦气进行检测, 以检测限 30 nmol/mol 作为不确定度, 则由制备引入的相对不确定度至少为 3% ; 而以 PED 检测限 1 nmol/mol 作为不确定度, 引入的相对不确定度为 0.1%。由此可见, 氦气的检测限对于研制高准确度氦气中微量氦气标准物质非常重要。

3 结语

利用等离子发射检测器 PED 对 3 瓶重量法制

用技术革新破解食品安全难题

80 后小伙陈建军开发一种试剂, 在 3~5 min 内快速检测出食品中的农药、兽药、毒素、重金属含量, 甚至能检测是否转基因。

食品安全大于天。蔬菜农残超标、肉里含有瘦肉精、奶里有三聚氰胺一波又一波的问题, 让人觉得吃啥也不放心。与之相对应的, 目前食品的国际检测方法成本高、周期长, 基层食品安全监管部门很难用上。

陈建军从代理产品做起, 2011 年某知名火腿肠品牌被检出含有瘦肉精, 引起轩然大波。瘦肉精其实主要有 3 种, 使用最多的就是盐酸克仑特罗, 其次是沙丁胺醇。陈建军说, 他代理的产品检测速度快, 价格适中, 中标了沙丁胺醇检测项目, 这次中标当年让他销售数百万元。但遗憾的是这个产品没有中标盐酸克仑特罗检测, 原因是速度不够快。企业把猪肉放在生产线上, 每次只停留 1 min, 当时只有一家企业的产品能 1 min 出结果。

备的氦气中微量氦气混合气进行了检测, 检测灵敏度较高。通过线性拟合, 得出了 PED 对氦气的检测限及检测限的不确定度, 为研制高准确度的微量氦气标准物质奠定了基础。配有 PED 新型检测器的气相色谱仪, 在检测微量氦气方面与常规仪器相比具有较高的灵敏度, 是目前检测氦气中微量氦气的理想仪器。

参考文献

- [1] GB/T 4844-2011 纯氦、高纯氦和超纯氦[S].
- [2] 蔡体杰, 刘雅珍, 张扬, 等. 关于氦离子化检测器气相色谱法分析氦中微量氦[J]. 低温与特气, 2012(4): 85-91.
- [3] 李富勇, 郭东方, 金伟, 等. 气相色谱用氦等离子体离子化检测器研究进展[J]. 分析科学学报, 2012(2): 279-284.
- [4] 胡树国, 金美兰, 盖良京. 利用脉冲放电氦电离质谱检测高纯气体中微量无机杂质[J]. 计量技术, 2007(6): 36-38.
- [5] 胡树国, 韩桥, 李春瑛. 高纯甲烷纯气体中的杂质分析——CCQM K66 国际比对[J]. 化学分析计量, 2009, 18(6): 67-69.
- [6] 黎文字, 张晓红. 等离子发射检测器(PED)及相关技术在气相色谱中的应用[J]. 低温与特气, 2014, 32(3): 48-54.
- [7] GB/T 5274-2008 气体分析校准用混合气体的制备称量法[S].
- [8] 胡树国, 李佳. 利用气体微量转移技术制备低含量 R12 气体标准物质[J]. 化学分析计量, 2012(6): 67-69.
- [9] 胡树国, 王德发, 王哲. 微量气体转移技术在重量法制备气体标准物质中的应用[J]. 计量学报, 2013(1): 72-75.
- [10] 刘渊, 建华, 王茂仁. 直线拟合中的不确定度计算[J]. 物理与工程, 2009, 19(2): 25-27.
- [11] 张体强, 胡树国, 韩桥. 大气压电离质谱及其用于超高纯气体分析研究进展[J]. 岩矿测试, 2014, 33(6): 775-781.
- [12] 张体强, 胡树国, 韩桥. 大气压电离质谱在超高纯气体纯度分析中的应用[J]. 分析测试学报, 2014, 33(7): 854-858.

2013 年起, 陈建军开始和华中农业大学专家合作开发转基因检测剂。由于检测准确度高、价格只有进口产品的 60%, 产品很快打开市场。不仅农业部门需要, 一些大米加工企业也需要用它来鉴别原料米是否混有转基因。随后又与湖北一些高校开展产学研合作, 研发出 30 多种自有品牌的检测试剂盒。

个人消费市场是陈建军的下一个目标。陈建军说: “我们刚刚研发出一种黄曲霉毒素的检测产品, 如果投入市场, 老百姓自己就可以在家里检测牛奶里的黄曲霉毒素是否超标, 甚至可以检测饭馆里是不是用了地沟油”。黄曲霉毒素是一种食物霉变就可产生的致癌物质, 变苦的坏瓜子、花生, 里面都含有它。奶牛如果吃了霉变的饲料, 牛奶里也可能残留黄曲霉毒素。

陈建军说, 虽然我们不是权威的食品安全状况发布机构, 但我们希望用自己的产品, 帮助大家吃到放心的食品。

(人民日报)

5.0 CHROMATOGRAMS



IMPURITIES

Chromatograms #

1,3-Butadiene (1,3-C ₄ H ₆)	73
Acetaldehyde	1-2-3-4-76
Acetic acid	5
Acetylene (C ₂ H ₂)	6-7-8-9-10-11-23-69-73-78-79-83-110-114
Ammonia	13-90
Argon (AR)	14-15-16-17-18-19-71-72-77-80-85-87-97-107-109-113
Arsine	20-21-22
Benzene(C ₆ H ₆)	76
Butadiene (C ₄ H ₆)	23
Butane (C ₄ H ₁₀)	23
Butylene	6-7-8
Butylene (C ₄ H ₈)	23
c-2-Butane (C-2-C ₄ H ₈)	73
Carbon dioxide (CO ₂)	1-24-25-26-27-64-65-30-19-31-32-33-23-34-35-36-37-66-67-71-73-74-75-78-79-80-81-82-83-84-90-96-99-100-105-111-115
Carbon monoxide (CO)	6-25-38-30-19-39-31-40-32-33-41-34-35-36-37-42-66-67-71-73-76-78-79-80-81-82-83-84-88-96-100-105-111-115
Carbonyl sulfide	5-43-44-45-46
Ethane (C ₂ H ₆)	6-7-8-9-10-23-69-73-78-79-110-114
Ethanol (C ₂ H ₆ O)	74
Ethylene (C ₂ H ₄)	6-7-8-9-10-23-69-73-78-79-83-110-114
Fluorine	87
Formaldehyde	3-4
Formic acid	5
Freon11	83
Freon113	83
Freon12	83
Freon13	83
Freon22	83
Helium	38-87-91
Hydrogen (H ₂)	6-25-18-38-30-58-19-39-32-33-34-35-36-37-66-67-78-80-81-82-91-95-105-111-116
Hydrogen sulfide	5-43-44-45-46
iso-Butane (i-C ₄ H ₁₀)	73
iso-Butylene (i-C ₄ H ₈)	73
iso-Pentane (i-C ₅ H ₁₂)	73
Krypton	18-47-70-72-77-80-85-87
Methane (CH ₄)	6-25-7-10-26-27-48-38-30-58-19-39-31-40-32-49-33-19-23-34-35-36-37-66-67-68-69-71-73-75-78-79-80-82-83-88-95-103-105-111-116
n-Pentane (N-C ₅ H ₁₂)	73
Neon (NE)	18-19-77-85-112
Nitrogen (N ₂).....	17-24-6-47-52-53-56-57-38-30-58-19-39-31-40-33-41-34-35-36-37-42-66-67-71-72-73-74-76-78-79-80-81-82-86-91-94-101-105-106-111-117
Nitrous oxide (N ₂ O)	11-27-48-54-49-23-5-75-81-83-106
Non-methane hydrocarbons (NMHC)	19-33-34-35-36-37-67-68-69-71-80-83-93-102
Oxygen (O ₂)	6-25-56-57-30-38-58-19-39-31-32-42-66-67-71-73-79-81-82-88-90-95-103-107-111-116
Phosphine	59-60-61
Propane	6-7-8-9-10-23
Propylene	6-7-8-9-10-23
Sulfur hexafluoride (SF ₆)	42-62-75-81-92-108
t-2-butane (T-2-C ₄ H ₈)	73
Tetrafluoromethane (CF ₄)	42-63-81-82-98-99-108
Tetrahydrothiophene	89
Trichloroethane	83
Trichloroethylene	83
Water	1-8-13-20-21-3-44-45-61-64-65
Xenon (XE)	70-77-80-85-88-104

CHROMATOGRAM #1

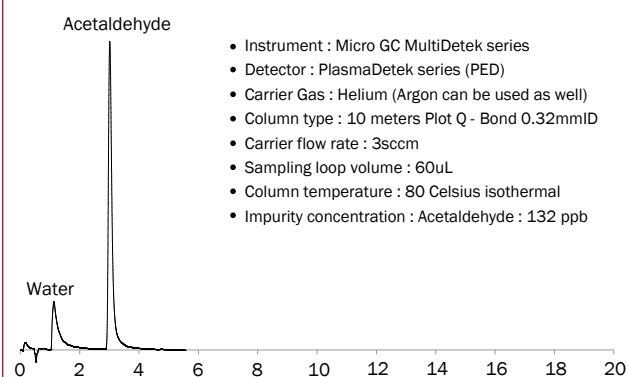

CHROMATOGRAM #2

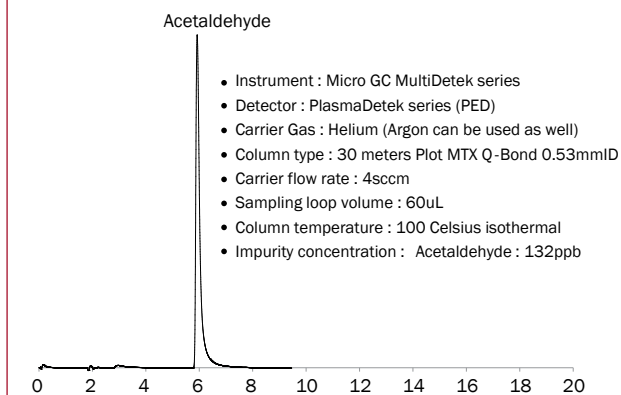

CHROMATOGRAM #3

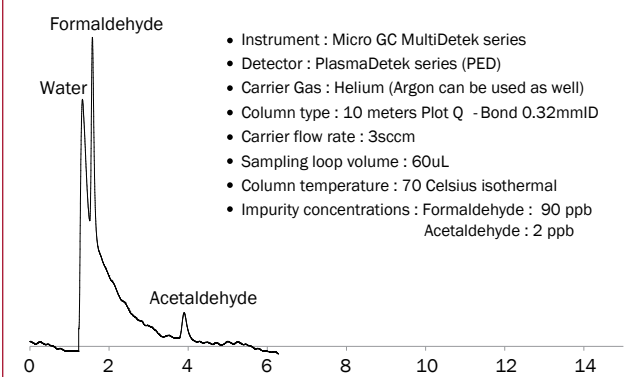

CHROMATOGRAM #4

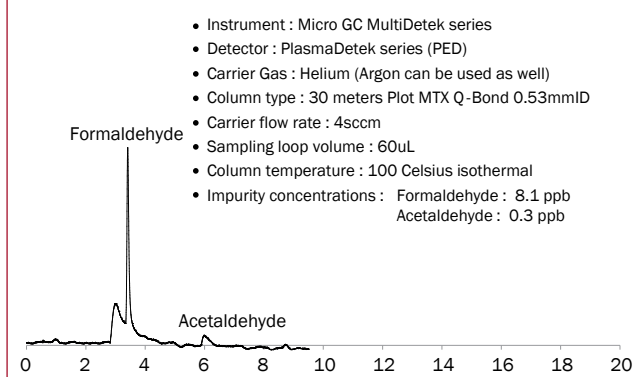

CHROMATOGRAM #5

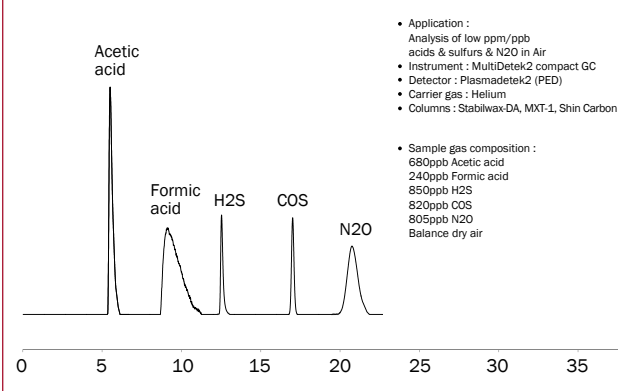

CHROMATOGRAM #6

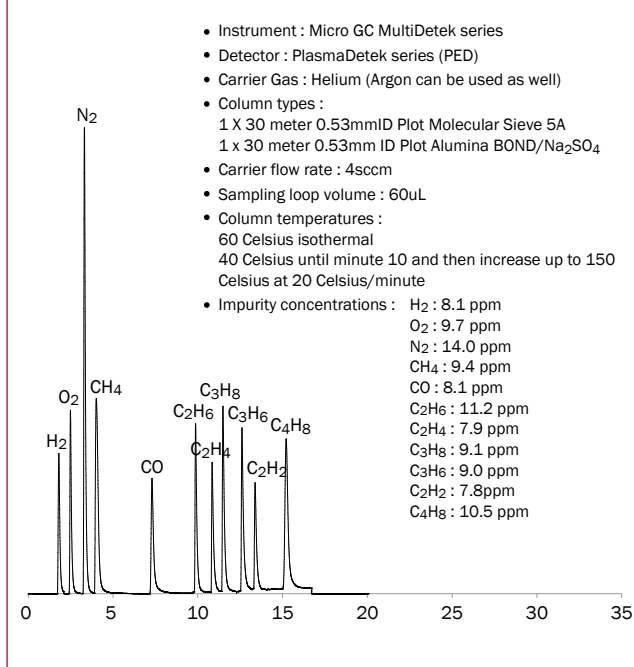

CHROMATOGRAM #7

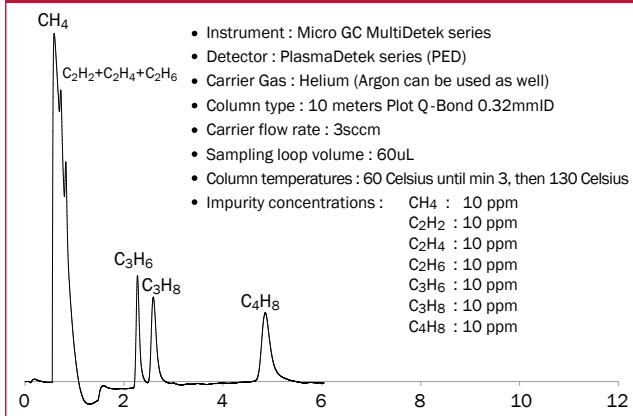

CHROMATOGRAM #8

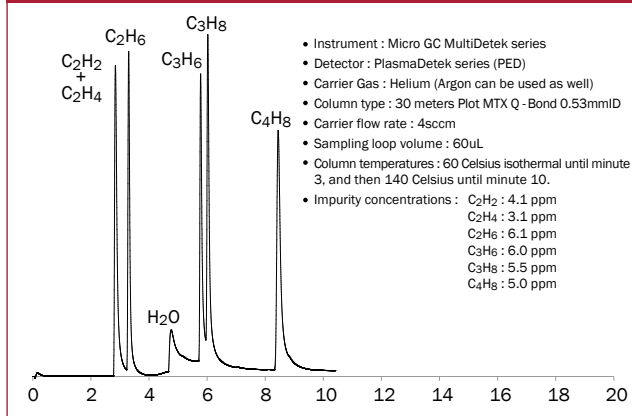

CHROMATOGRAM #9

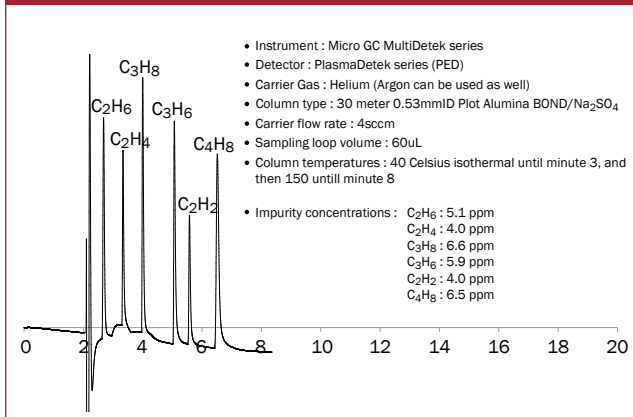

CHROMATOGRAM #10

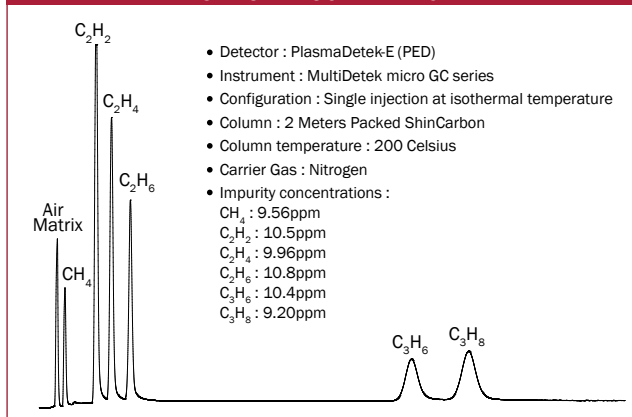

CHROMATOGRAM #11

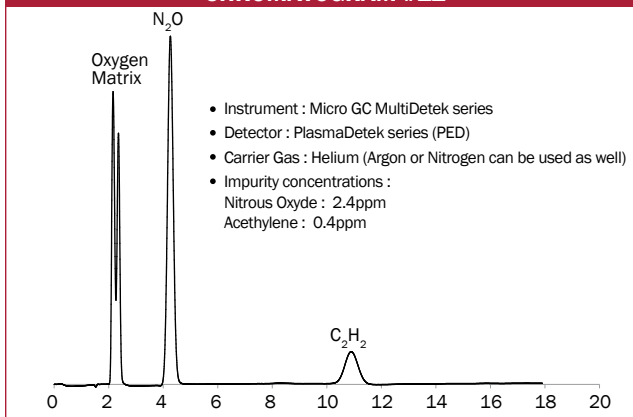

CHROMATOGRAM #13

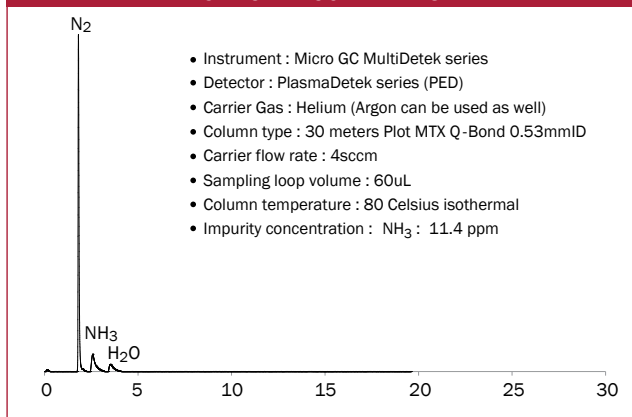

CHROMATOGRAM #14

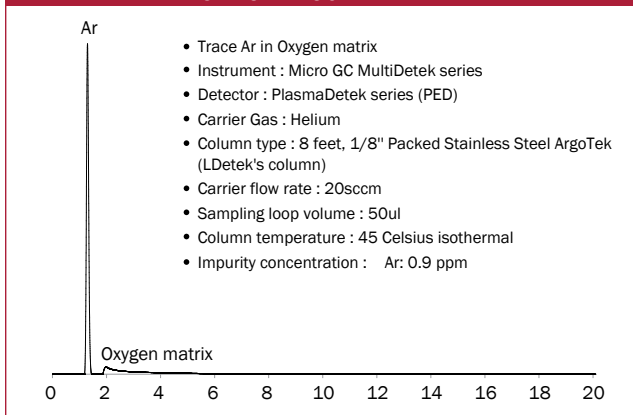

CHROMATOGRAM #15

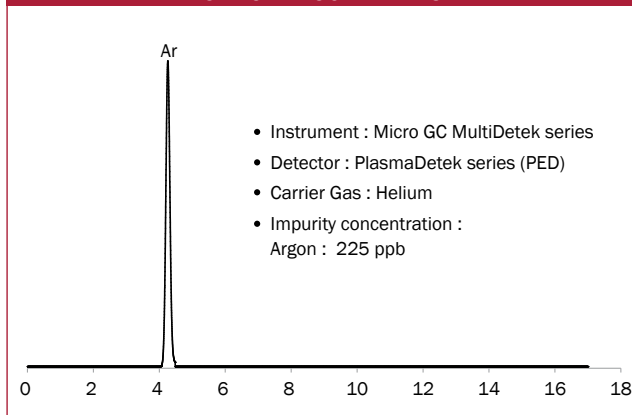

CHROMATOGRAM #16

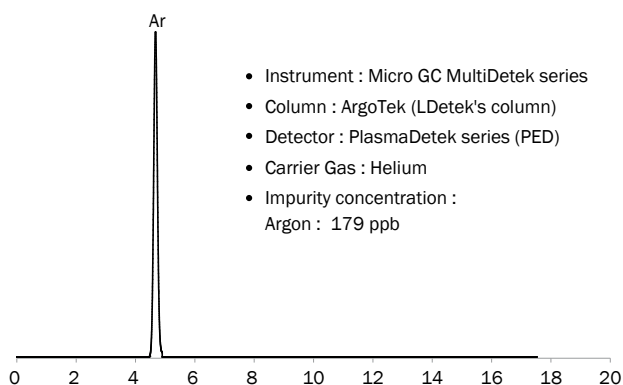

CHROMATOGRAM #17

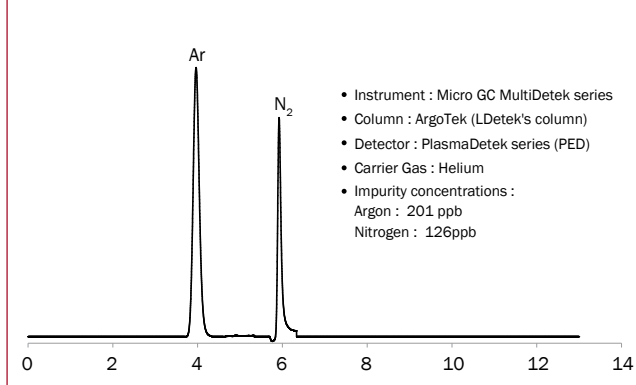

CHROMATOGRAM #18

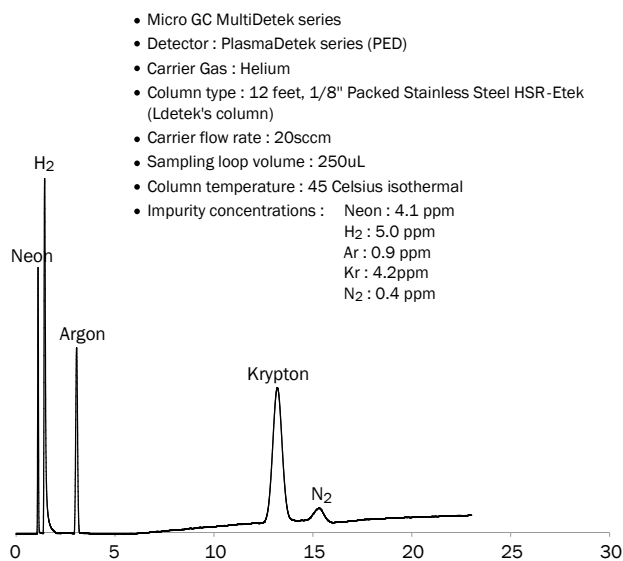

CHROMATOGRAM #19

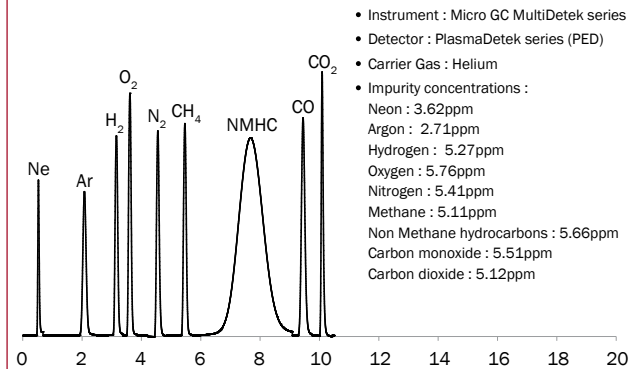

CHROMATOGRAM #21

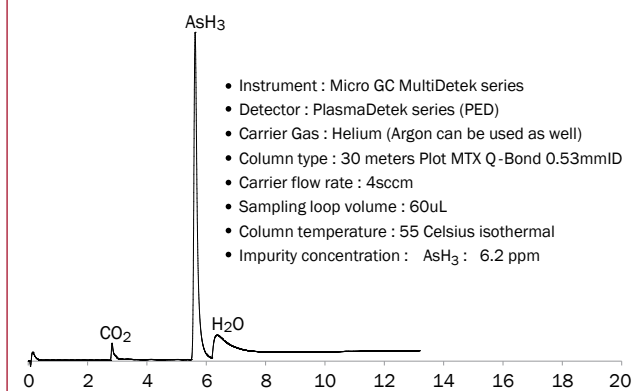

CHROMATOGRAM #20

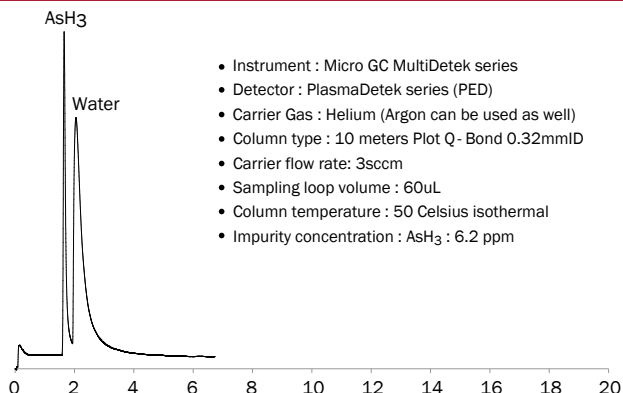

CHROMATOGRAM #22

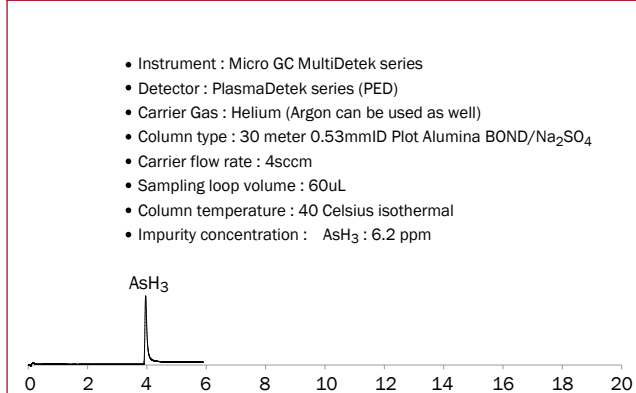

CHROMATOGRAM #23

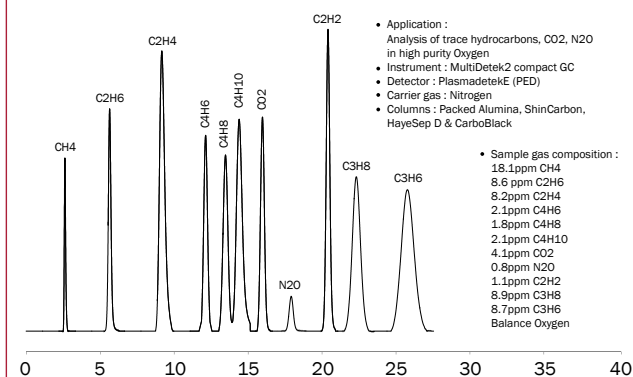

CHROMATOGRAM #24

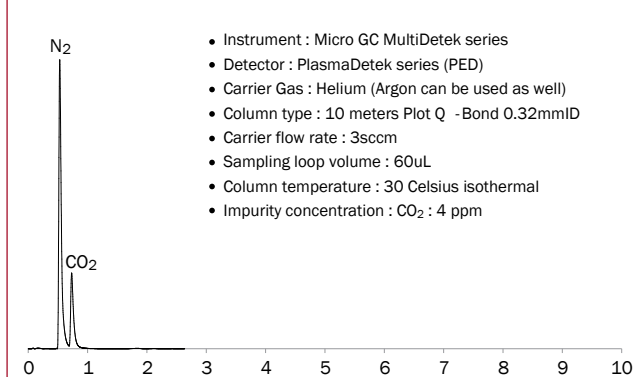

CHROMATOGRAM #25

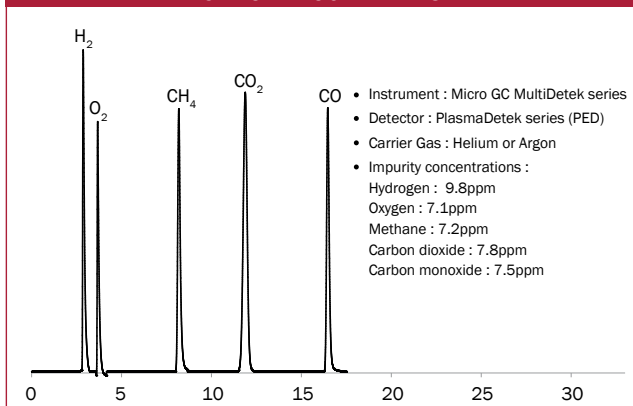

CHROMATOGRAM #26

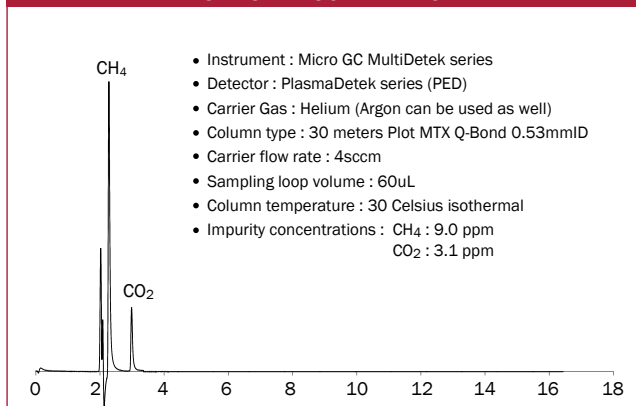

CHROMATOGRAM #27

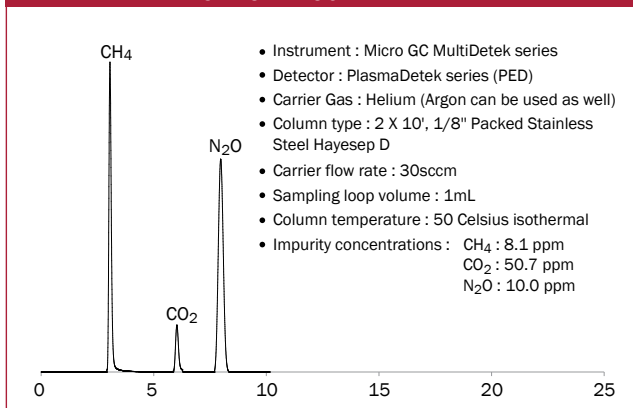

CHROMATOGRAM #30

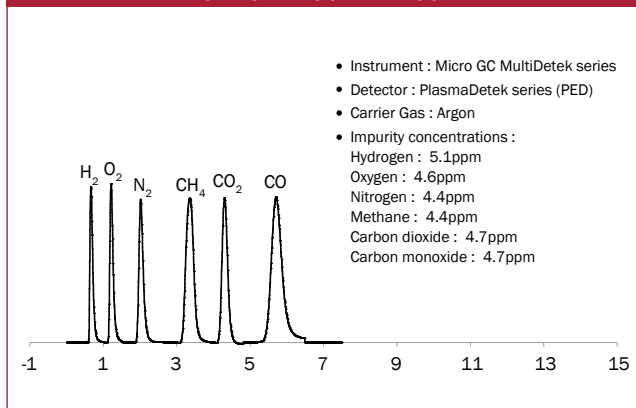

CHROMATOGRAM #31

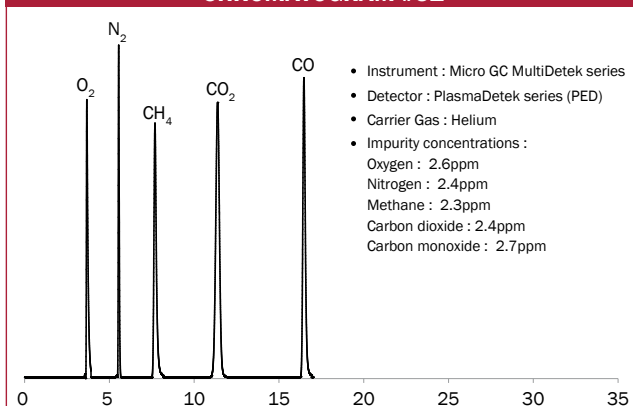

CHROMATOGRAM #32

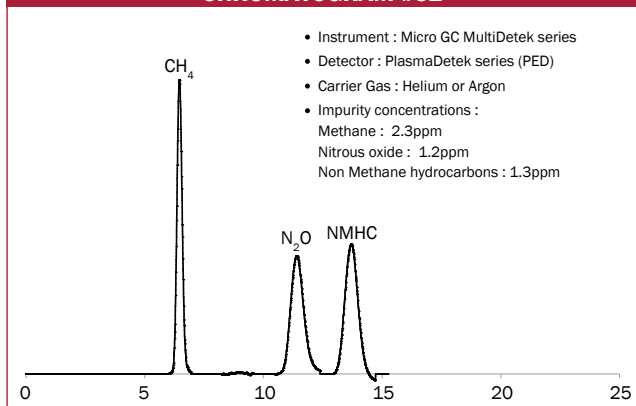

CHROMATOGRAM #33

- Instrument : Micro GC MultiDetek series
- Detector : PlasmaDetek series (PED)
- Carrier Gas : Argon
- Impurity concentrations :
Nitrogen : 0.9ppm
Carbon monoxide : 0.7ppm

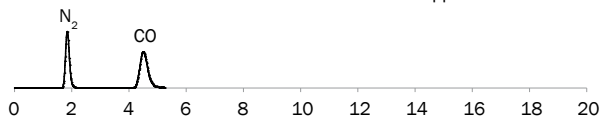

CHROMATOGRAM #34

- Application : Analysis of low ppb H2-NMHC-CH4-N2-CO2-CO in electronic grade gas Oxygen
- Instrument : MultiDetek2 compact GC
- Detector : Plasmadetek-E (PED)
- Carrier gas : Helium
- Columns: Packed
- Sample gas composition :
H2 : 3.1ppb
NMHC : 3.2ppb
CH4 : 0.9ppb
N2 : 2.1ppb
CO2 : 2.3ppb
CO : 1.0ppb

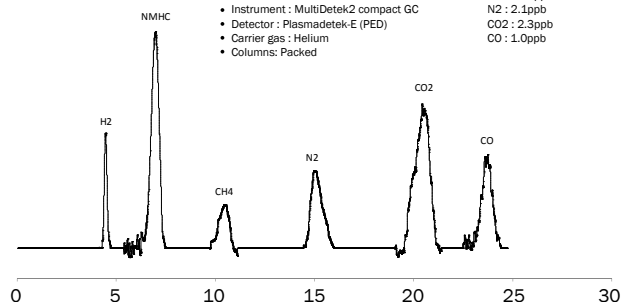

CHROMATOGRAM #35

- Application : Analysis of low ppb H2-NMHC-CH4-N2-CO2-CO in electronic grade gas Oxygen
- Instrument : MultiDetek2 compact GC
- Detector : Plasmadetek-E (PED)
- Carrier gas : Helium
- Columns: Packed
- Sample gas composition :
H2= 7.5ppb
NMHC : 9.1ppb
CH4= 6.1ppb
N2= 7.2 ppb
CO2 =5.9ppb
CO= 4.1ppb

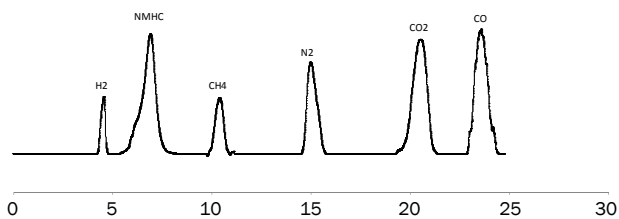

CHROMATOGRAM #36

- Application : Analysis of low ppb H2-NMHC-CH4-N2-CO2-CO in electronic grade gas Oxygen
- Instrument : MultiDetek2 compact GC
- Detector : Plasmadetek-E (PED)
- Carrier gas : Helium
- Columns: Packed
- Sample gas composition :
H2 = 38.2ppb
NMHC : 25.2ppb
CH4 = 36.8 ppb
N2 = 36.9 ppb
CO2= 26.4 ppb
CO= 36.4 ppb

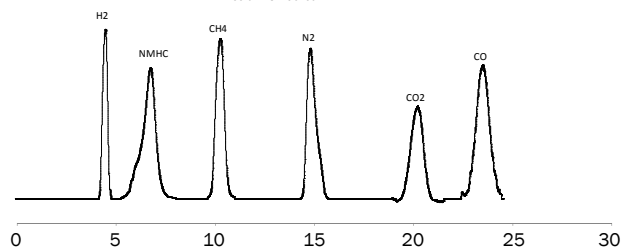

CHROMATOGRAM #37

- Application : Analysis of low ppb H2-NMHC-CH4-N2-CO2-CO in electronic grade gas Oxygen
- Instrument : MultiDetek2 compact GC
- Detector : Plasmadetek-E (PED)
- Carrier gas : Helium
- Columns: Packed
- Sample gas composition :
H2 : 111.9ppb
NMHC : 129.2ppb
CH4 : 87.6ppb
N2 : 124.3ppb
CO2 : 84.4ppb
CO : 95.6ppb

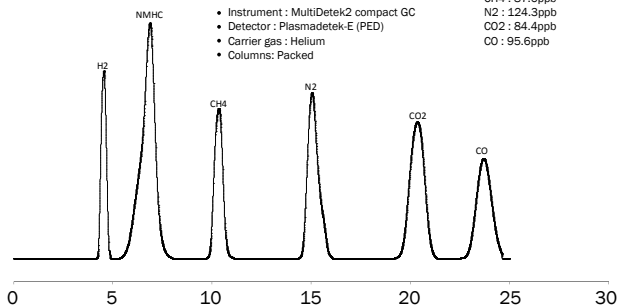

CHROMATOGRAM #38

- Instrument : Micro GC MultiDetek series
- Detector : PlasmaDetek series (PED) & TCD
- Carrier Gas : Helium & Argon
- Impurity concentrations :
Oxygen : 10.6ppm
Nitrogen : 10.4ppm
Methane : 10.4ppm
Carbon monoxide : 10.7ppm
Helium : 45ppm
Hydrogen : 0.5ppm

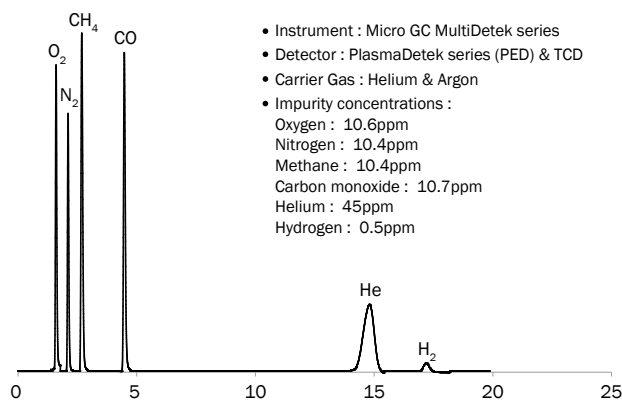

CHROMATOGRAM #39

- Instrument : Micro GC MultiDetek series
- Detector : PlasmaDetek series (PED)
- Carrier Gas : Helium
- Column type : 30 meters Plot Molecular Sieve 0.53mmID
- Carrier flow rate : 3sccm
- Sampling loop volume : 160uL
- Column temperature : 70 Celsius isothermal
- Impurity concentrations :
Hydrogen : 0.1ppm
Oxygen : 1.6ppm
Nitrogen : 1.4ppm
Methane : 1.4ppm
Carbon monoxide : 1.7ppm

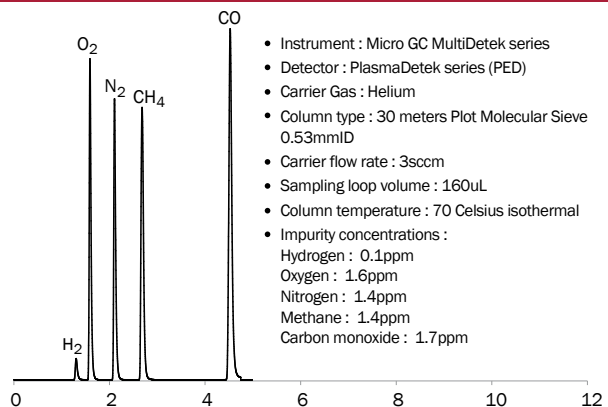

CHROMATOGRAM #40

- Instrument : Micro GC MultiDetek series
- Detector : PlasmaDetek series (PED)
- Carrier Gas : Argon
- Impurity concentrations :
Nitrogen : 1.1ppm
Methane : 1.2ppm
Carbon monoxide : 1.7ppm

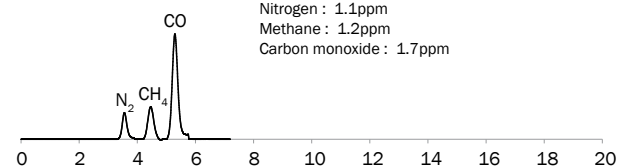

CHROMATOGRAM #41

- Instrument : Micro GC MultiDetek series
 - Detector : PlasmaDetek series (PED)
 - Carrier Gas : Helium or Argon
- Impurity concentrations :
- Methane : 5.38ppm
 - Carbon dioxide : 4.12ppm
 - Hydrogen : 4.73ppm
 - Nitrogen : 5.86ppm
 - Non Methane hydrocarbons : 5.38ppm
 - Carbon monoxide : 4.92ppm

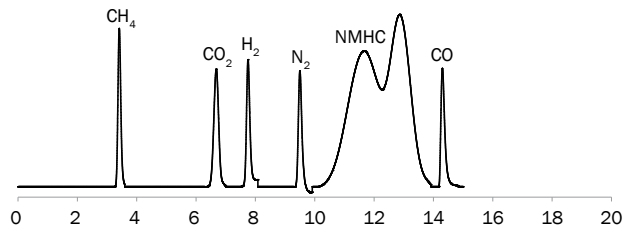

CHROMATOGRAM #42

- Application : Sulfur hexafluoride purity (SF6)
 - Instrument : MultiDetek2 GC
 - Detector : Plasmadetek2
 - Carrier gas : Argon or Helium
- Sample gas :
- O2 : 1495ppm
 - N2 : 1448ppm
 - CF4 : 125ppm
 - CO : 199ppm in SF6

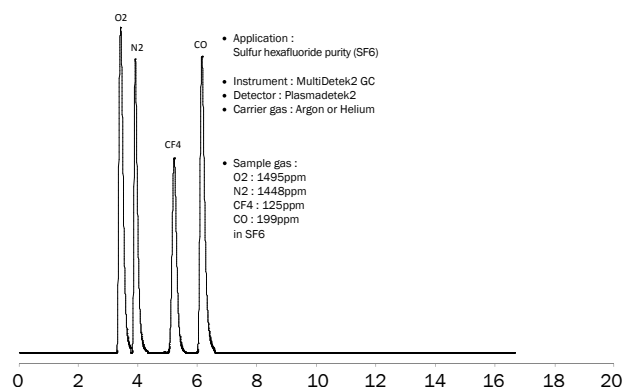

CHROMATOGRAM #43

Nitrogen matrix

- Instrument : Micro GC MultiDetek series
- Detector : PlasmaDetek series (PED)
- Carrier Gas : Argon (Helium can be used as well)
- Column type : 1 meter micro packed 1/16"OD Rt -XLSulfurs
- Carrier flow rate : 8sccm
- Sampling loop volume : 200uL
- Column temperature : 60 Celsius isothermal
- Impurity concentrations : H₂S : 9.8 ppm
COS : 9.4 ppm

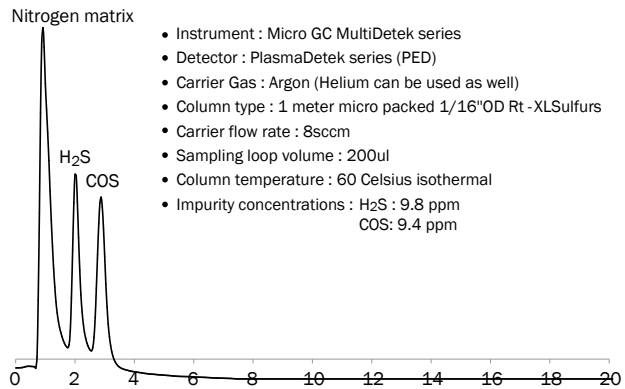

CHROMATOGRAM #44

- Instrument : Micro GC MultiDetek series
- Detector : PlasmaDetek series (PED)
- Carrier Gas : Helium (Argon can be used as well)
- Column type : 30 meters Plot MTX - Q-Bond 0.53mmID
- Carrier flow rate : 4sccm
- Sampling loop volume : 60uL
- Column temperature : 100 Celsius isothermal
- Impurity concentrations : H₂S : 6.4 ppm
COS : 5.1 ppm

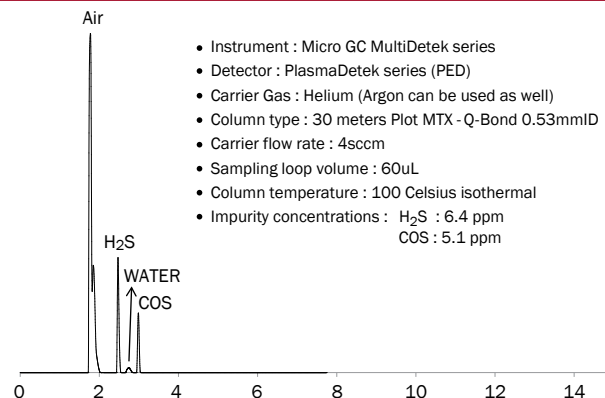

CHROMATOGRAM #45

- Instrument : Micro GC MultiDetek series
- Detector : PlasmaDetek series (PED)
- Carrier Gas : Helium (Argon can be used as well)
- Column type : 10 meters Plot Q - Bond 0.32mmID
- Carrier flow rate : 3sccm
- Sampling loop volume : 60uL
- Column temperature : 30 Celsius isothermal
- Impurity concentrations : H₂S : 6.4 ppm
COS : 5.1 ppm

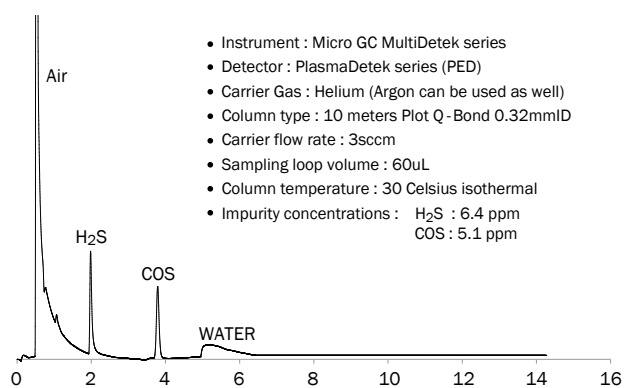

CHROMATOGRAM #47

Oxygen matrix

- Instrument : Micro GC MultiDetek series
- Detector : PlasmaDetek series (PED)
- Carrier Gas : Helium (Argon can be used as well)
- Column type : 12 feet 1/8" Packed Stainless Steel HSR-Etek (LDetek's column)
- Carrier flow rate : 20sccm
- Sampling loop volume : 250uL
- Column temperature : 45 Celsius isothermal
- Impurity concentrations : Kr : 9.8 ppm
N₂ : 10.9 ppm

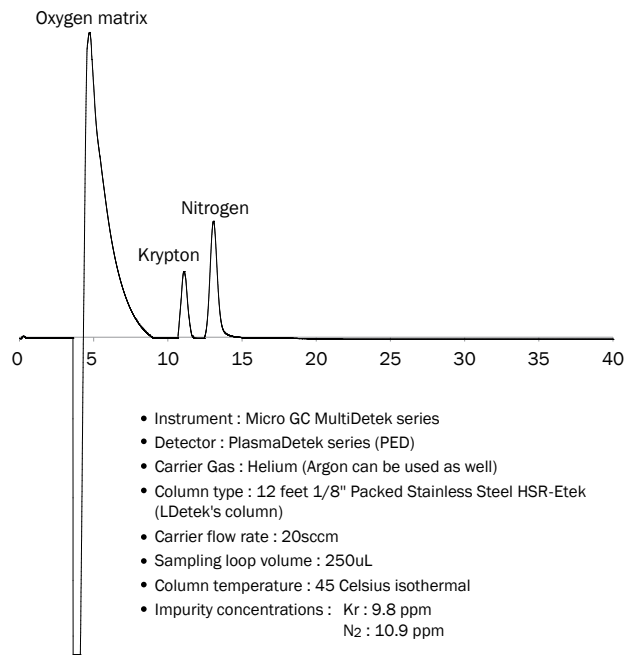

CHROMATOGRAM #46

- Instrument : Micro GC MultiDetek series
- Detector : PlasmaDetek series (PED)
- Carrier Gas : Helium (Argon can be used as well)
- Column type : 30 meters GasPro 0.32mmID
- Carrier flow rate : 3sccm
- Sampling loop volume : 140uL
- Impurity concentrations : H₂S : 1.1ppm
COS : 0.8ppm

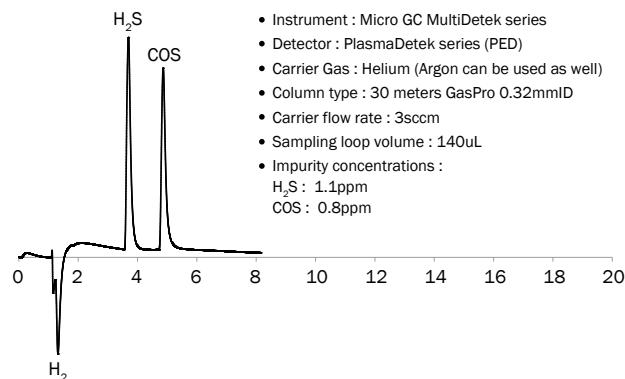

CHROMATOGRAM #48

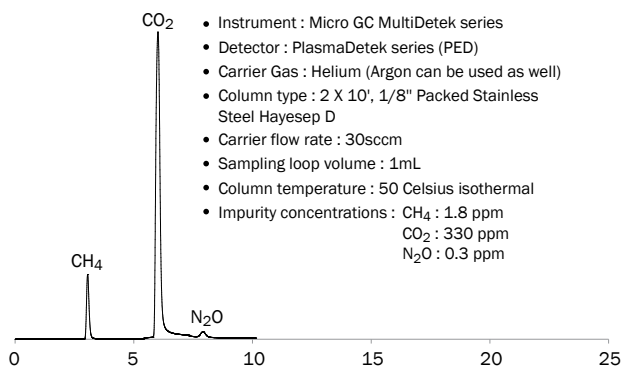

CHROMATOGRAM #49

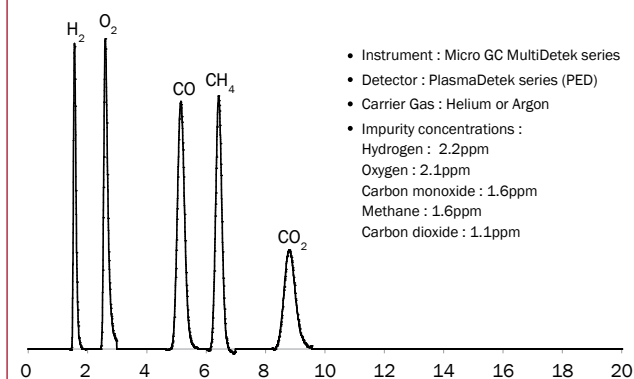

CHROMATOGRAM #52

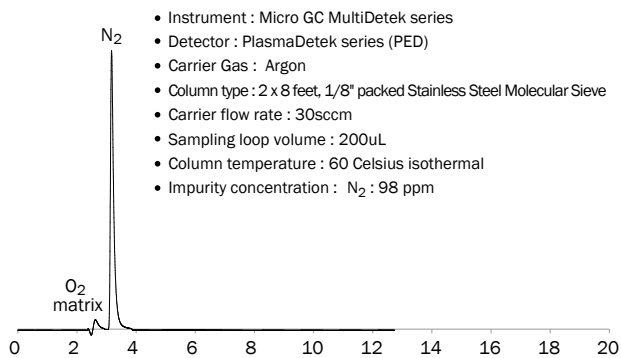

CHROMATOGRAM #53

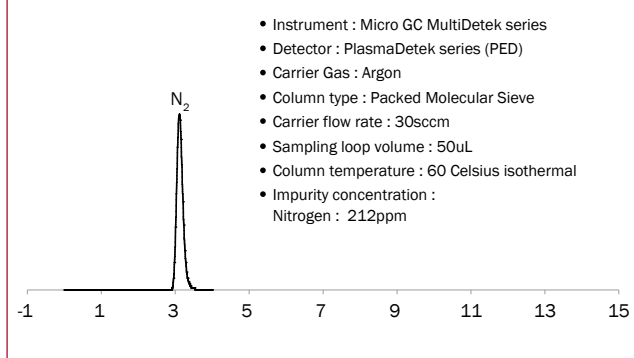

CHROMATOGRAM #54

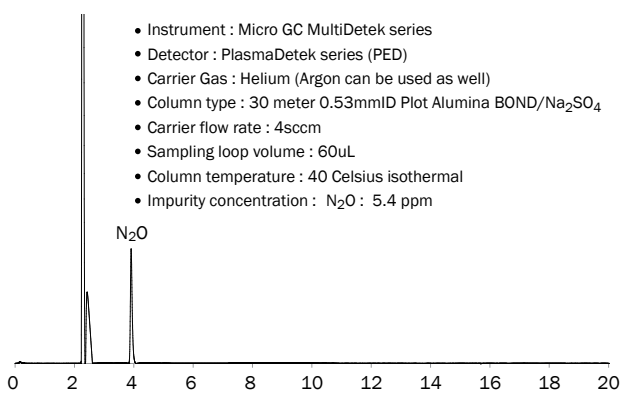

CHROMATOGRAM #56

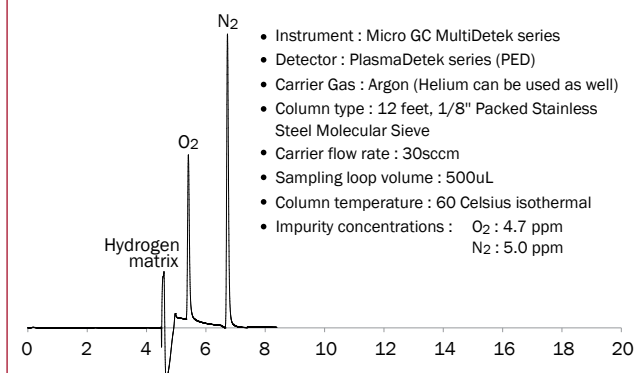

CHROMATOGRAM #57

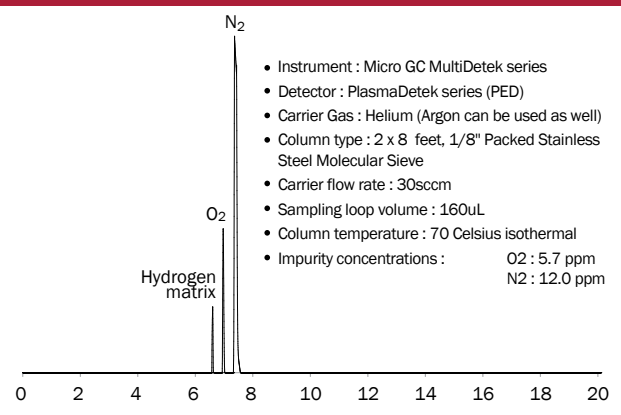

CHROMATOGRAM #58

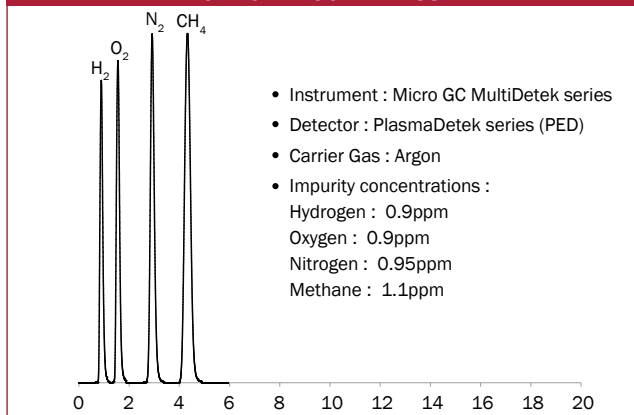

CHROMATOGRAM #59

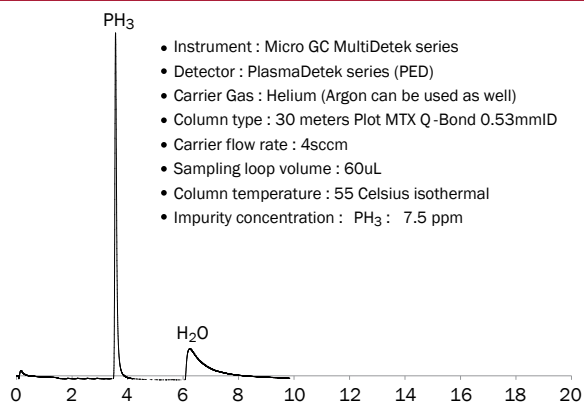

CHROMATOGRAM #60

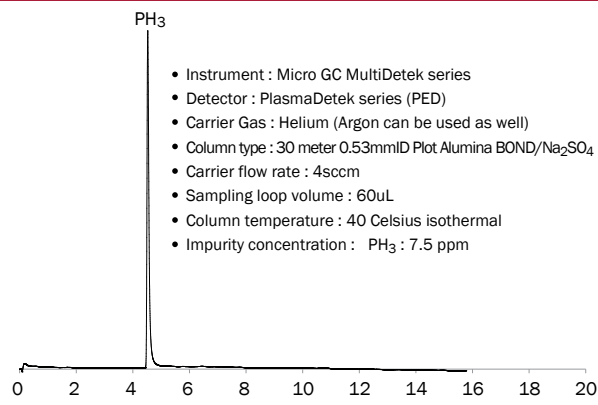

CHROMATOGRAM #61

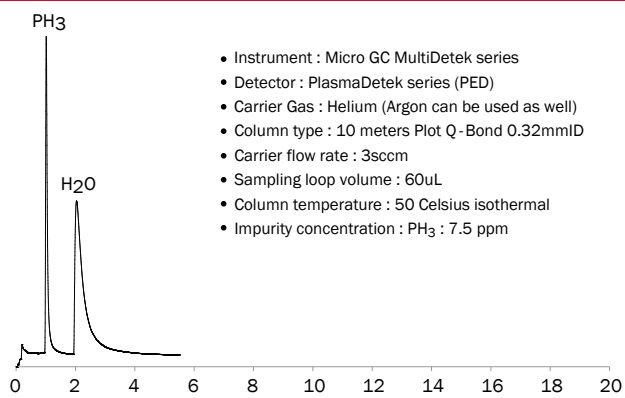

CHROMATOGRAM #62

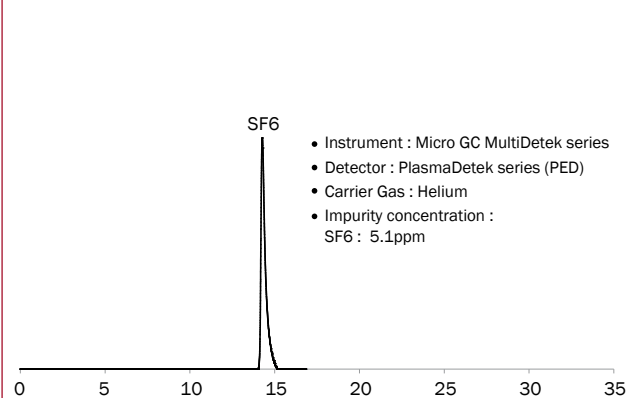

CHROMATOGRAM #63

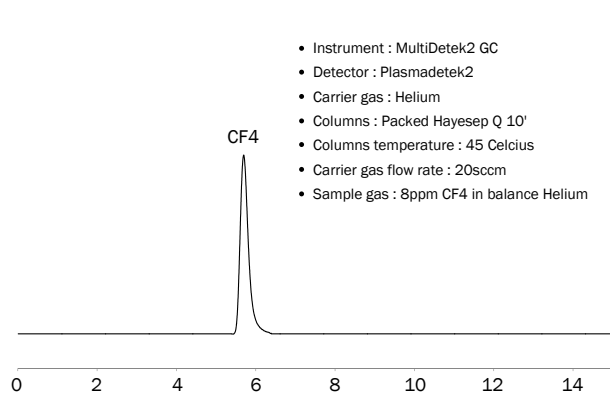

CHROMATOGRAM #64

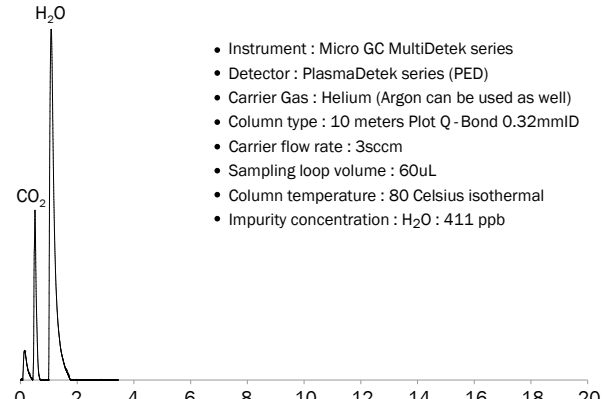

CHROMATOGRAM #65

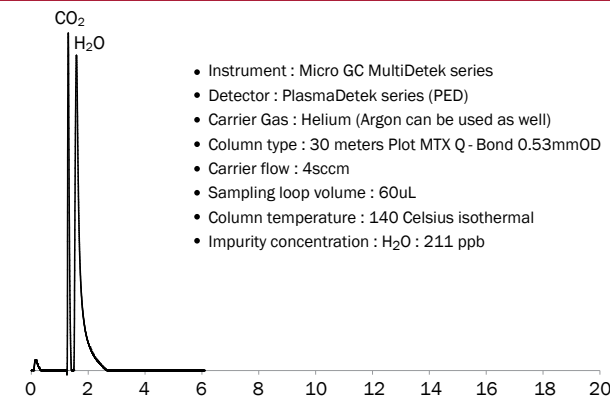

CHROMATOGRAM #66

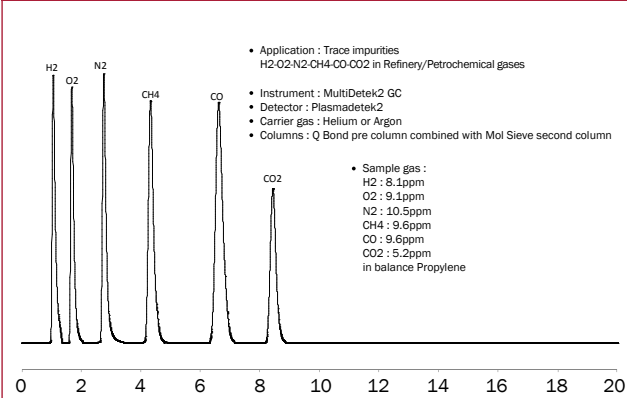

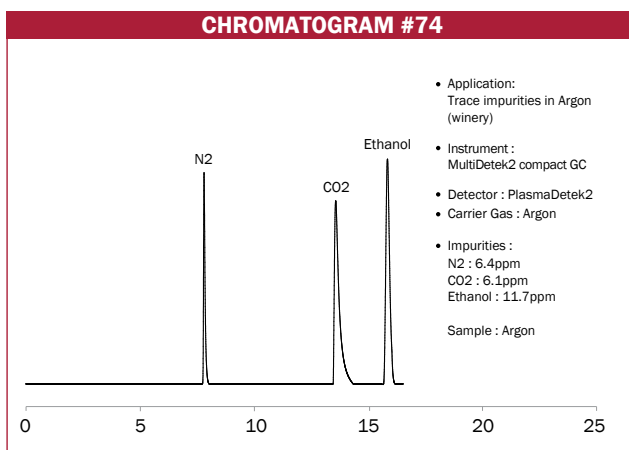
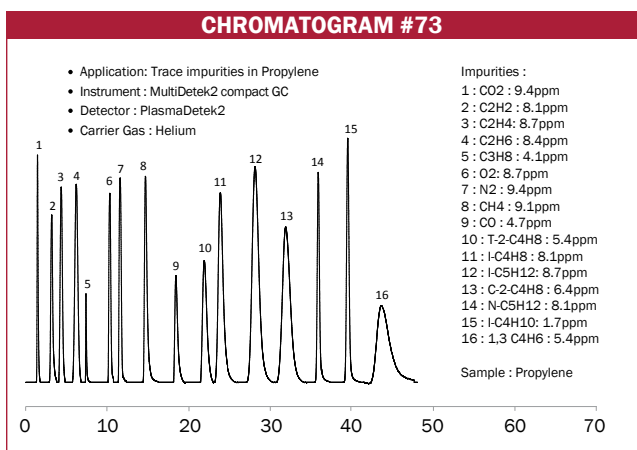
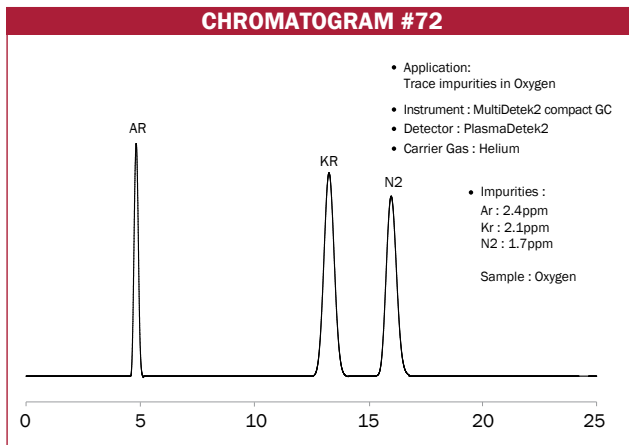
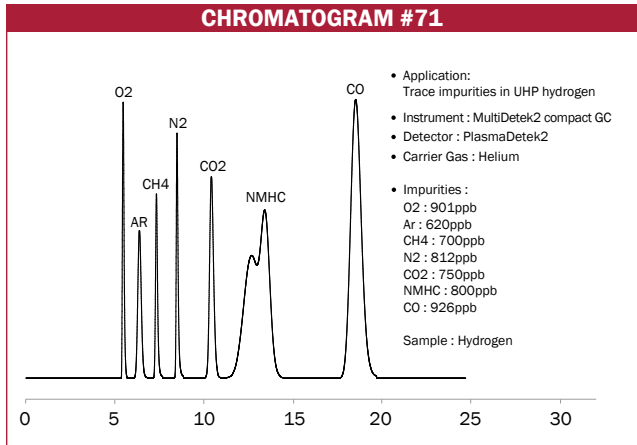
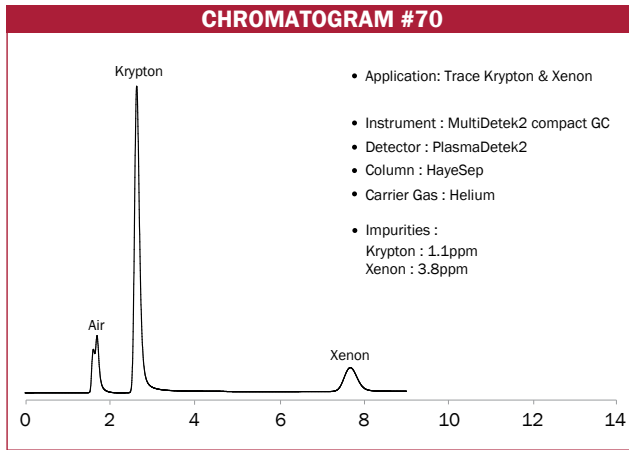
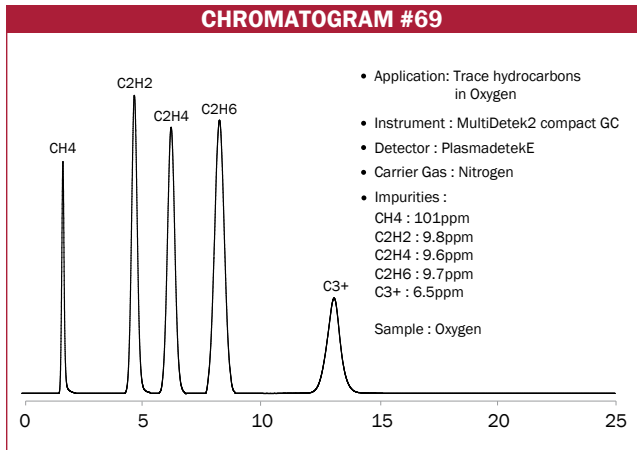
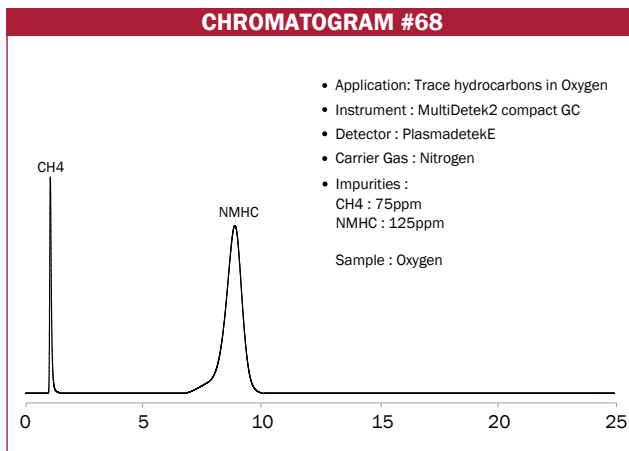
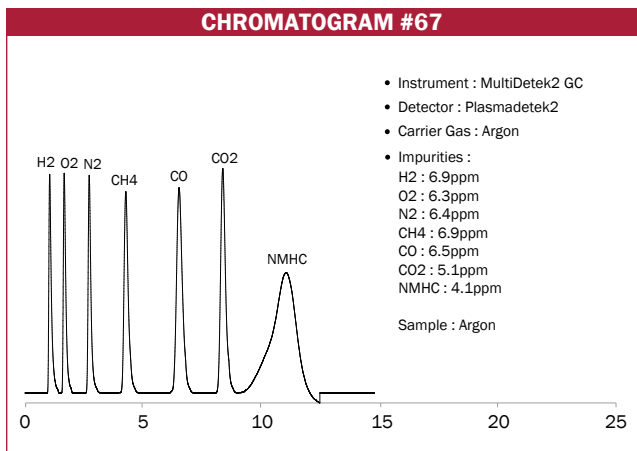

CHROMATOGRAM #75

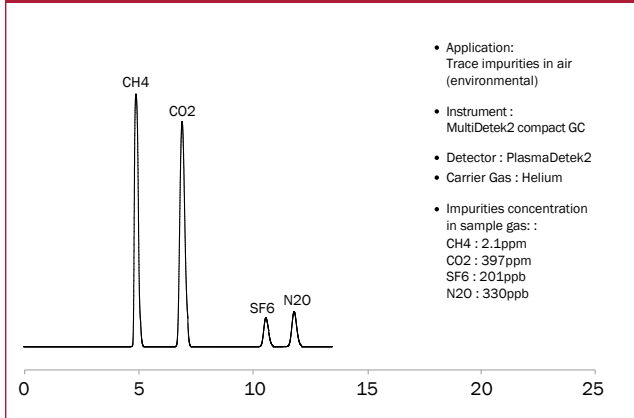

CHROMATOGRAM #76

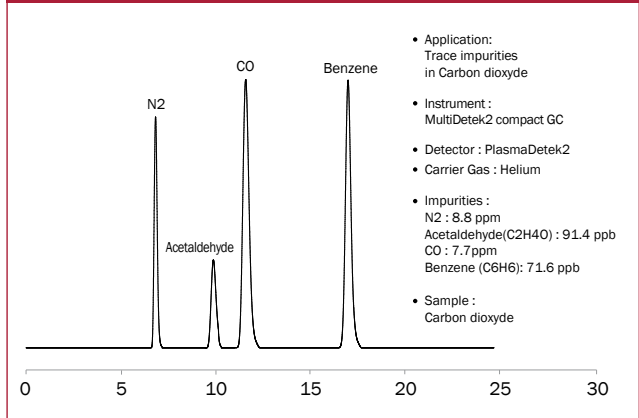

CHROMATOGRAM #77

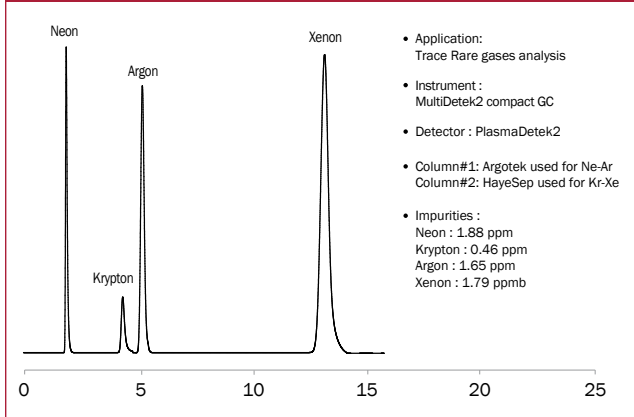

CHROMATOGRAM #78

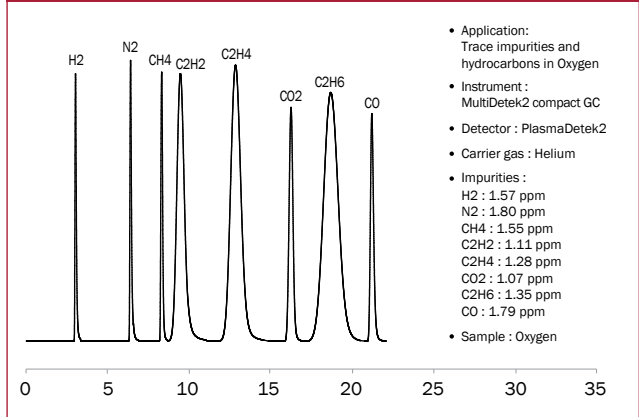

CHROMATOGRAM #79

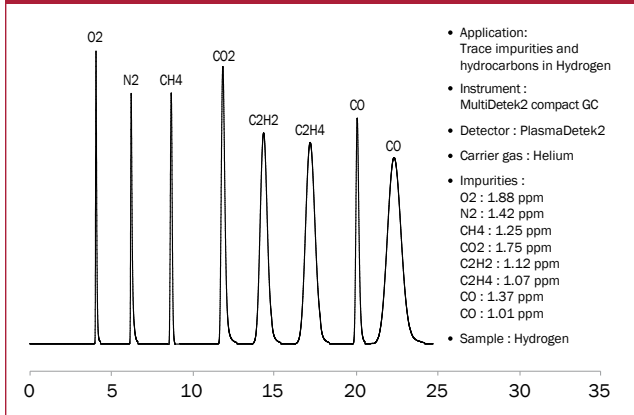

CHROMATOGRAM #80

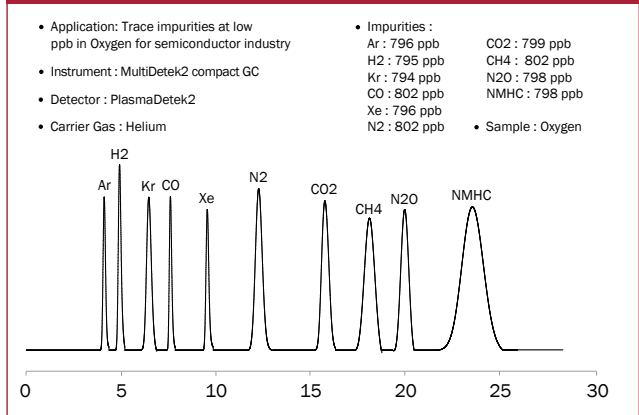

CHROMATOGRAM #81

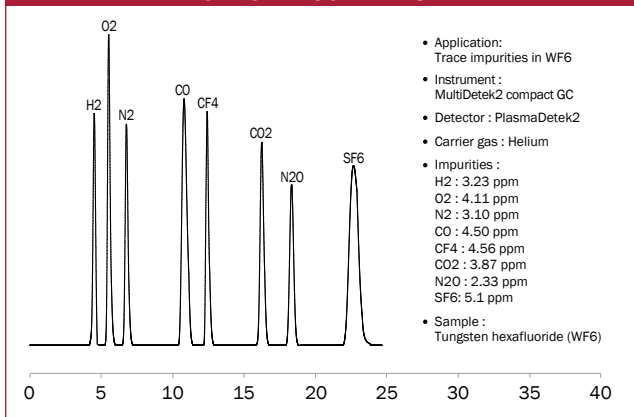

CHROMATOGRAM #82

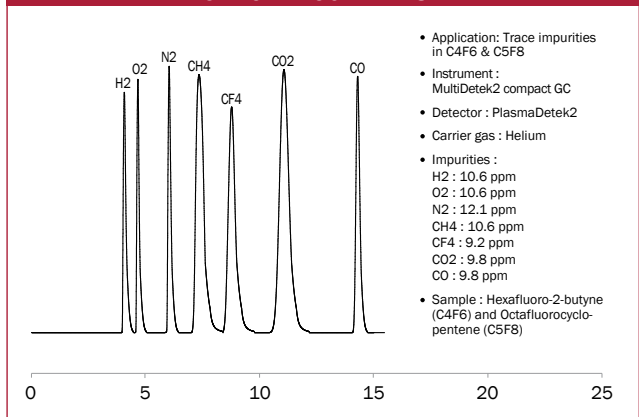

CHROMATOGRAM #83

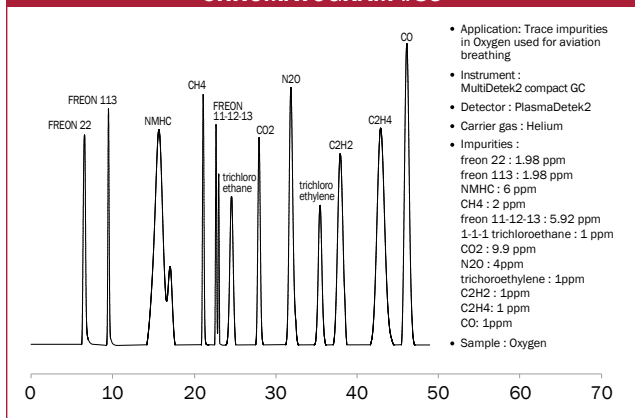

CHROMATOGRAM #84

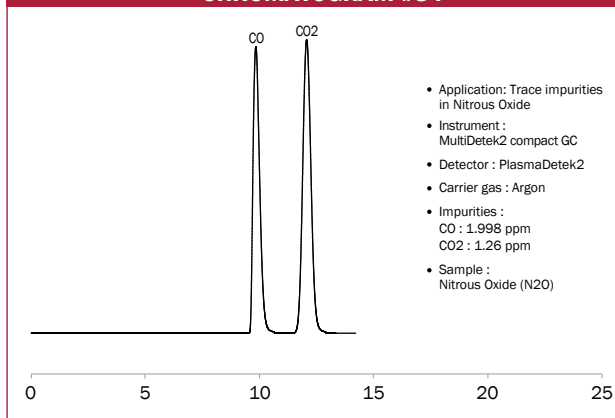

CHROMATOGRAM #85

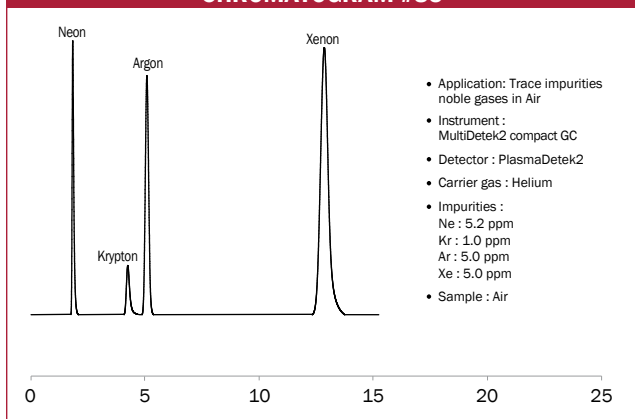

CHROMATOGRAM #86

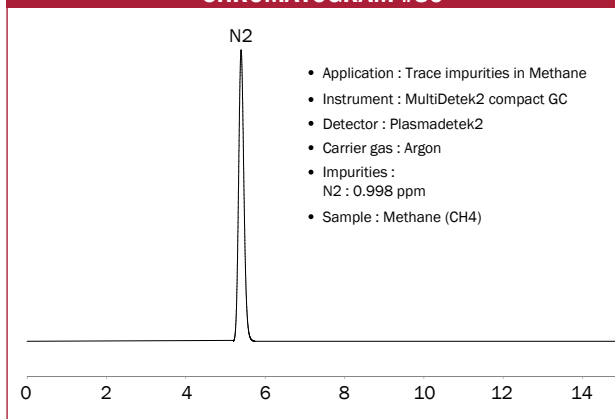

CHROMATOGRAM #87

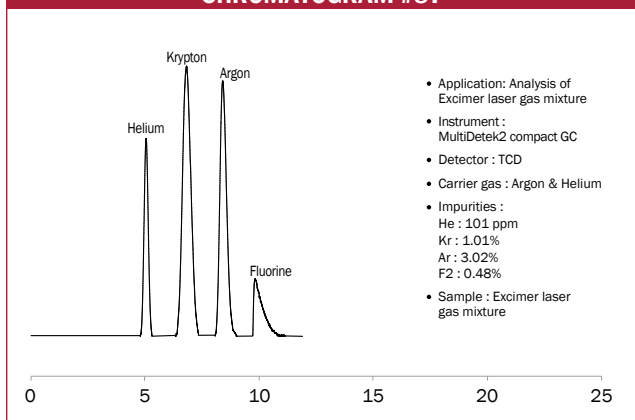

CHROMATOGRAM #88

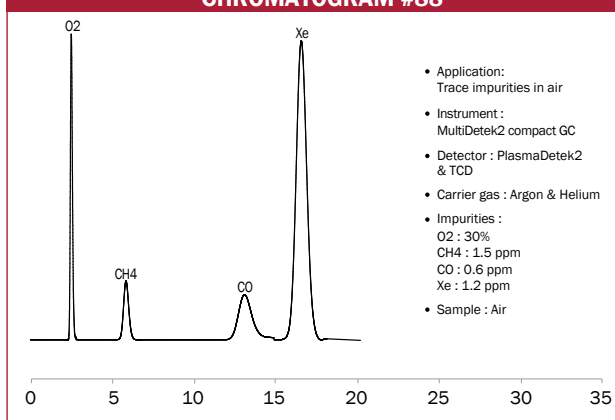

CHROMATOGRAM #89

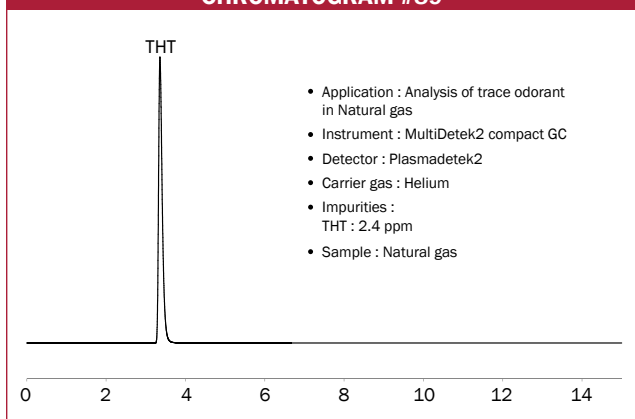

CHROMATOGRAM #90

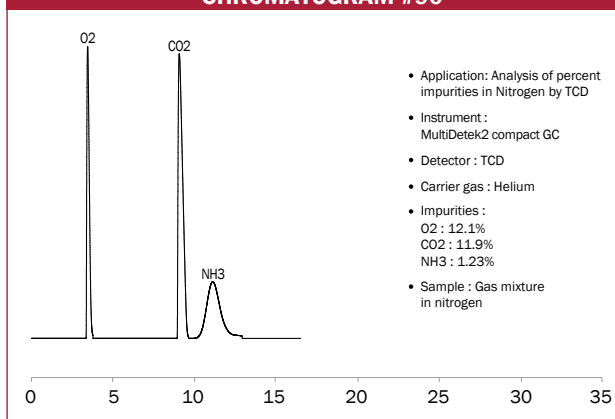

CHROMATOGRAM #91

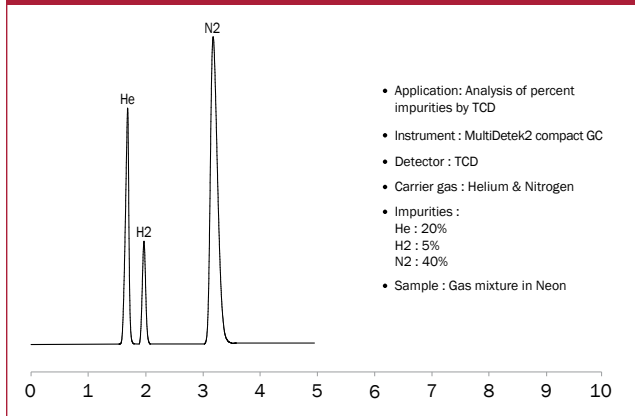

CHROMATOGRAM #92

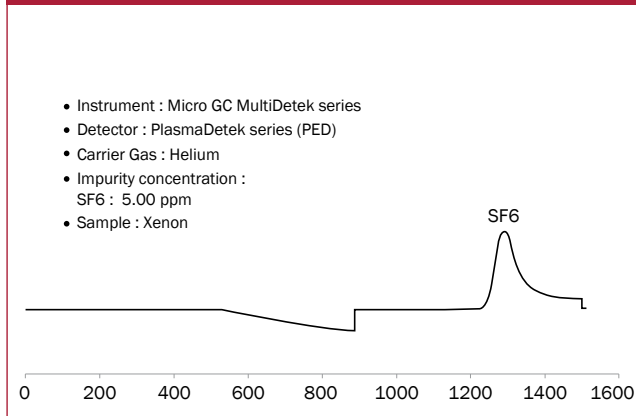

CHROMATOGRAM #93

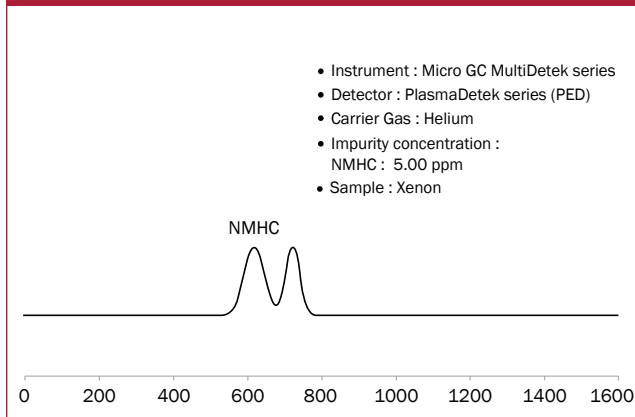

CHROMATOGRAM #94

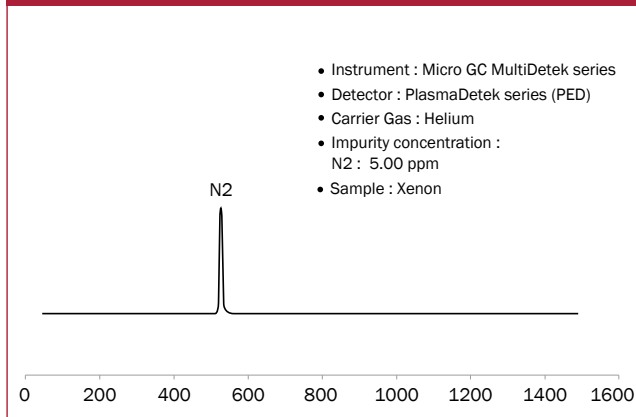

CHROMATOGRAM #95

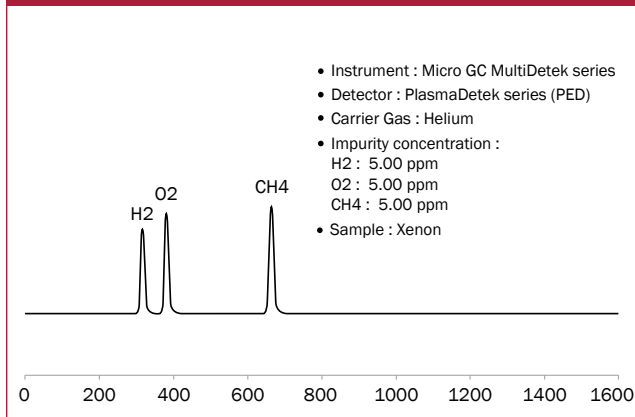

CHROMATOGRAM #96

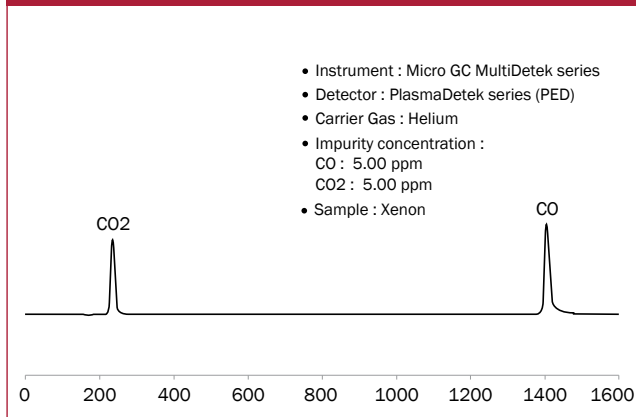

CHROMATOGRAM #97

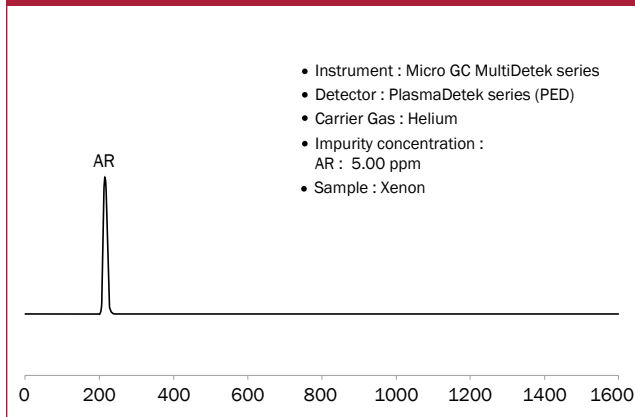

CHROMATOGRAM #98

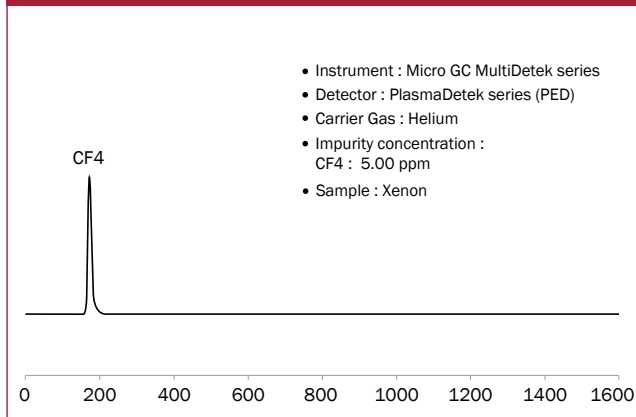

CHROMATOGRAM #99

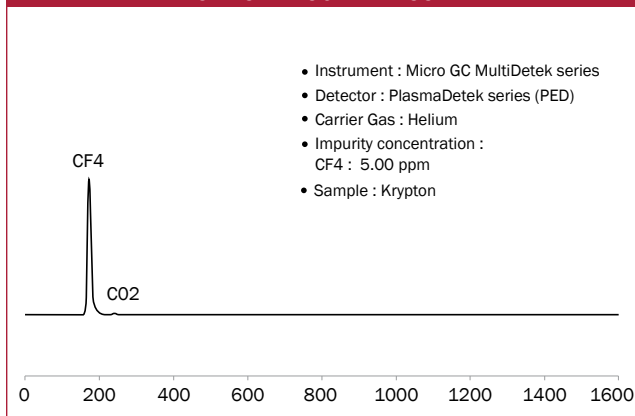

CHROMATOGRAM #100

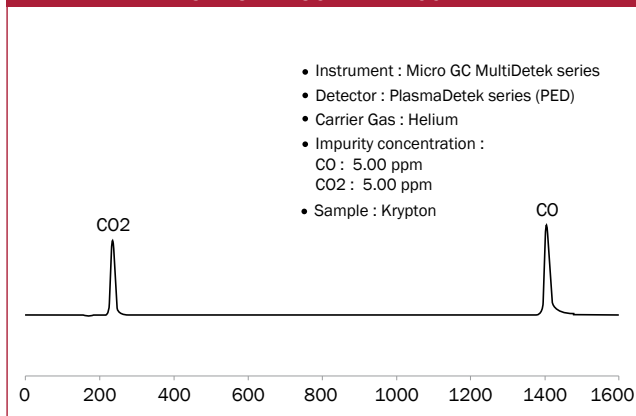

CHROMATOGRAM #101

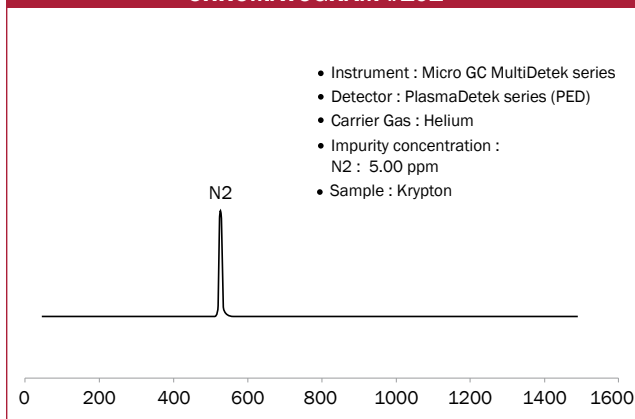

CHROMATOGRAM #102

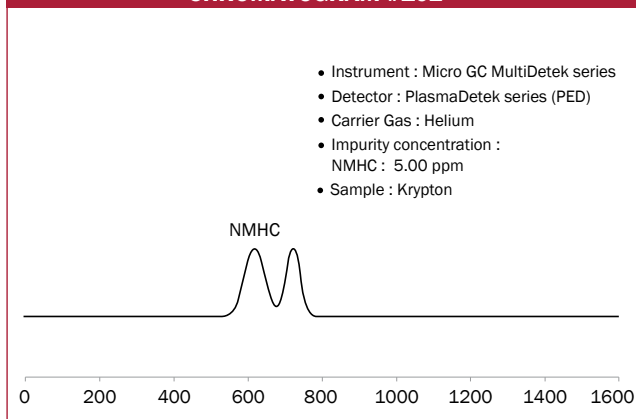

CHROMATOGRAM #103

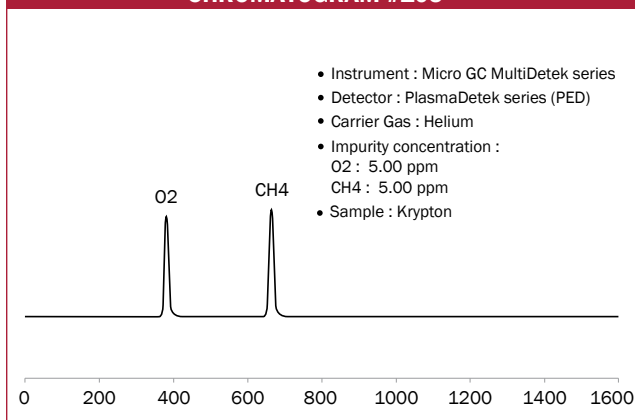

CHROMATOGRAM #104

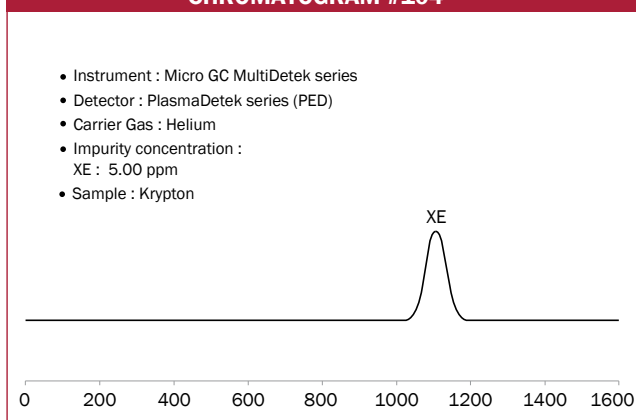

CHROMATOGRAM #105

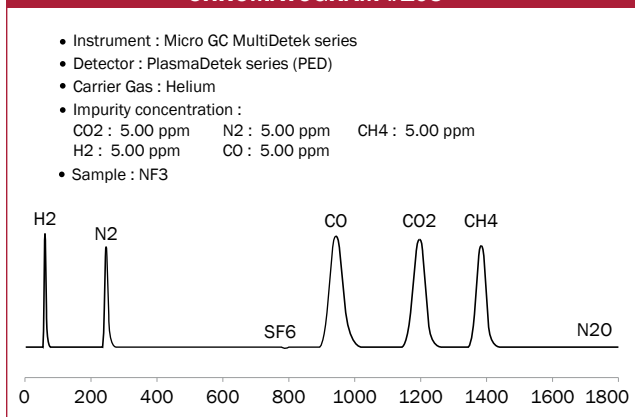

CHROMATOGRAM #106

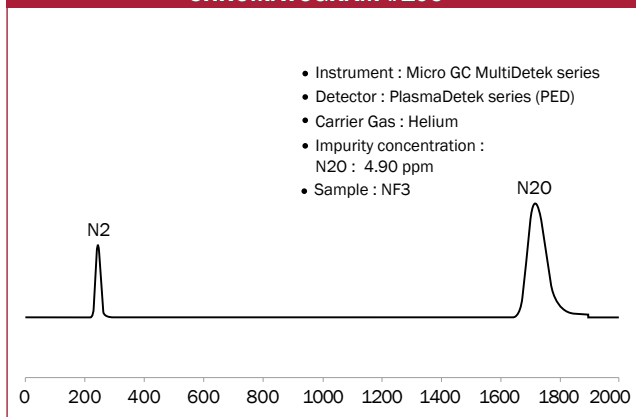

CHROMATOGRAM #107

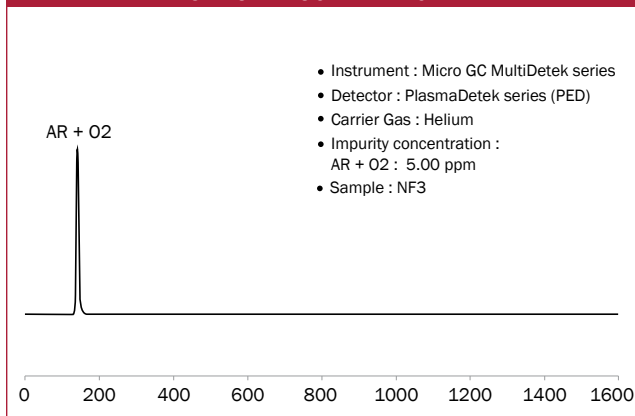

CHROMATOGRAM #108

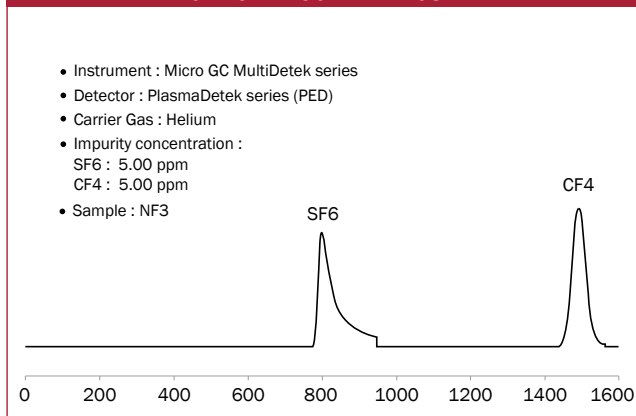

CHROMATOGRAM #109

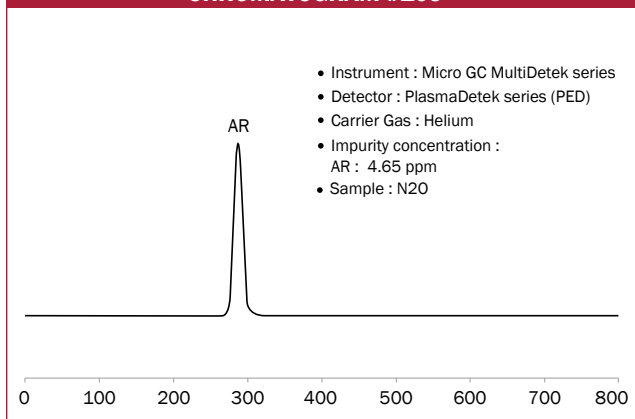

CHROMATOGRAM #110

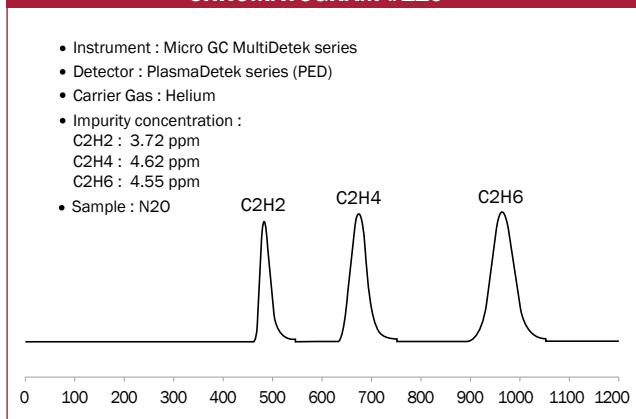

CHROMATOGRAM #111

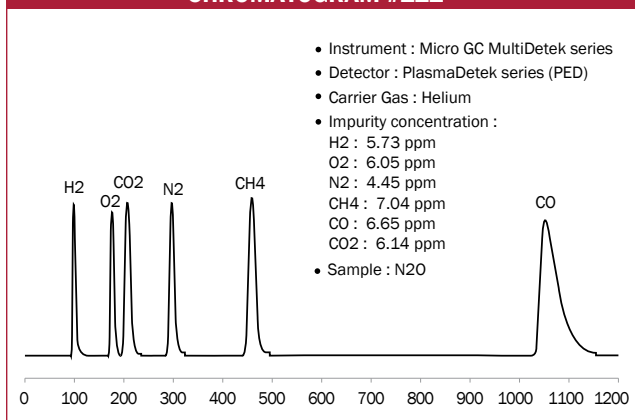

CHROMATOGRAM #112

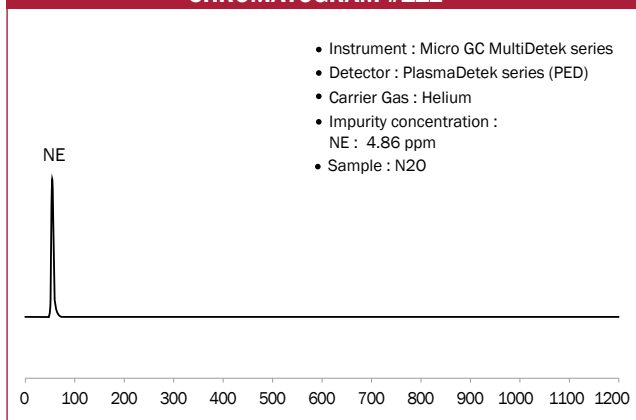

CHROMATOGRAM #113

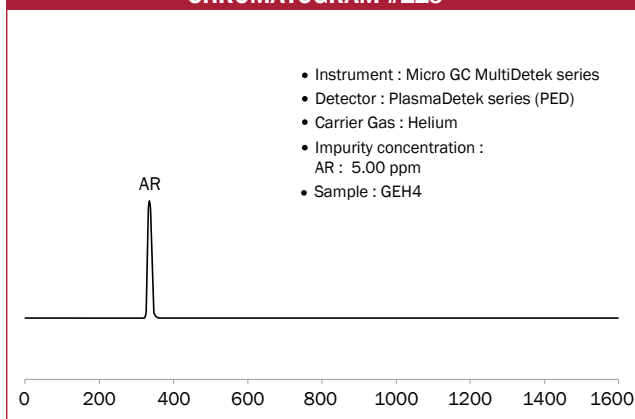

CHROMATOGRAM #114

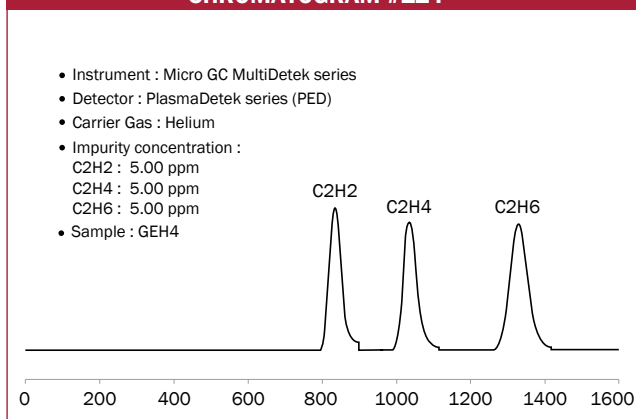

CHROMATOGRAM #115

- Instrument : Micro GC MultiDetek series
- Detector : PlasmaDetek series (PED)
- Carrier Gas : Helium
- Impurity concentration :
CO : 5.00 ppm
CO2 : 5.00 ppm
- Sample : GEH4

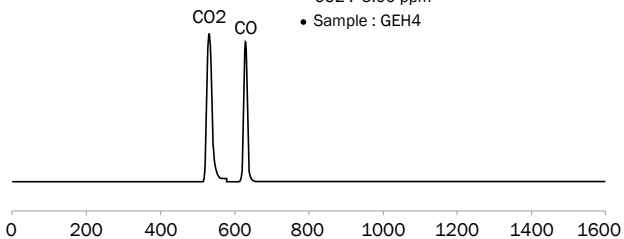

CHROMATOGRAM #116

- Instrument : Micro GC MultiDetek series
- Detector : PlasmaDetek series (PED)
- Carrier Gas : Helium
- Impurity concentration :
H2 : 5.00 ppm
CH4 : 5.00 ppm
O2 : 5.00 ppm
- Sample : GEH4

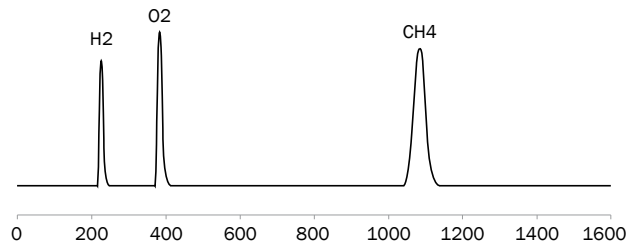

CHROMATOGRAM #117

- Instrument : Micro GC MultiDetek series
- Detector : PlasmaDetek series (PED)
- Carrier Gas : Helium
- Impurity concentration :
N2 : 5.00 ppm
- Sample : GEH4

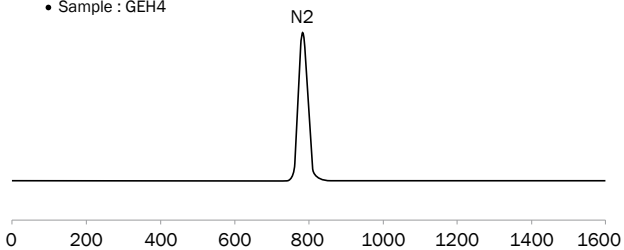

SAMPLES

Chromatograms #

Air	5-10-44-45-48-75-85-88
Argon	30-54-58-67-74
Carbon Dioxide	76
Crude Argon	52-53
Ethylene	66
Excimer laser gas mixture	87
Germane (GeH ₄)	113-114-115-116-117
Helium	19-39
Hexafluoro-2-butyne	82
Hydrogen	15-31-40-46-56-57-71-79
Hydrogen Chloride	25
Krypton	99-100-101-102-103-104
Methane	86
Natural gas	50-51-89
Neon	38-91
Nitrogen	9-13-16-32-43-49-90
Nitrogen trifluoride (NF ₃)	105-106-107-108
Nitrous oxide (N ₂ O)	84-109-110-111-112
Octafluorocyclopentene	82
Oxygen	11-14-17-23-33-34-35-36-37-41-47-68-69-72-78-80-83
Propylene	66-73
Sulfur hexafluoride	42-63
Syngas	44-45
Tungsten hexafluoride	81
Xenon	62-92-93-94-95-96-97-98

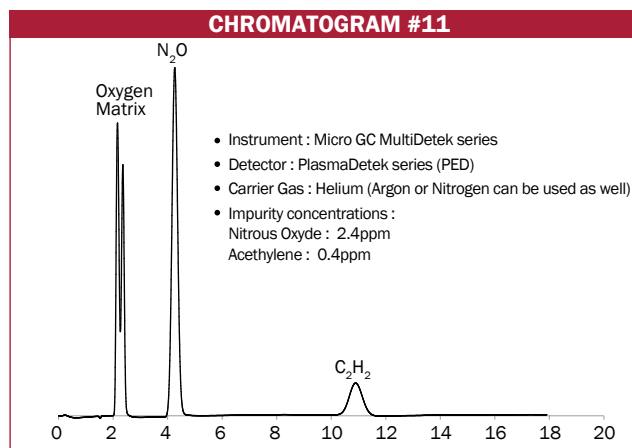
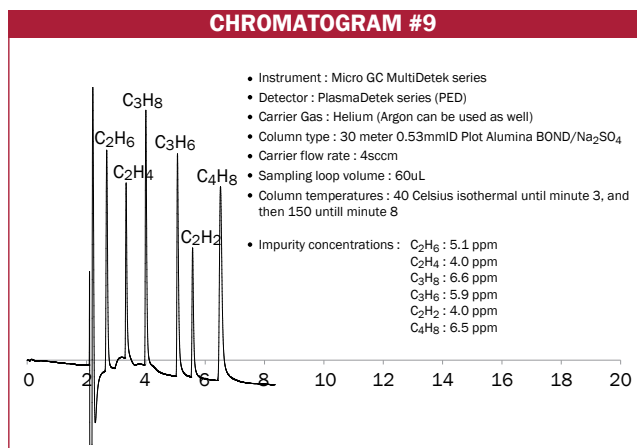
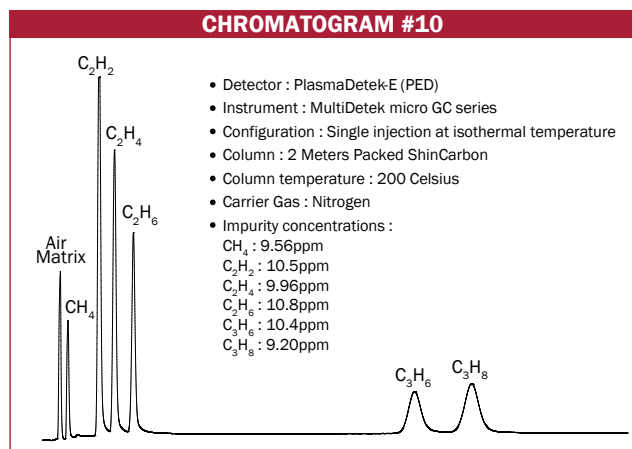
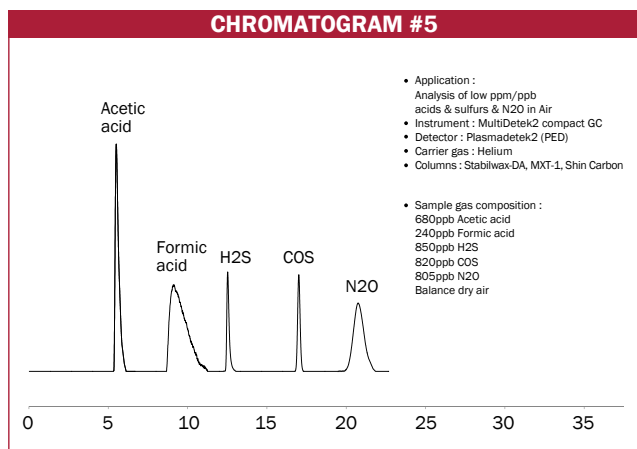

CHROMATOGRAM #13

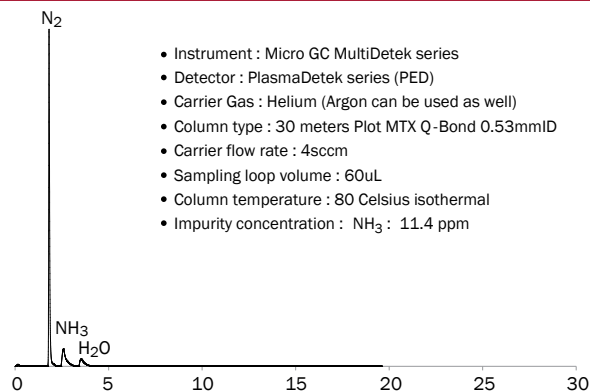

CHROMATOGRAM #14

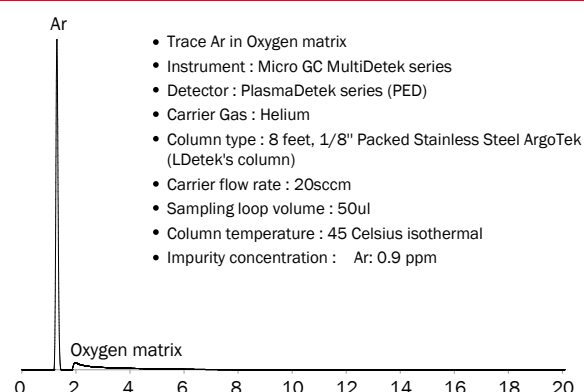

CHROMATOGRAM #15

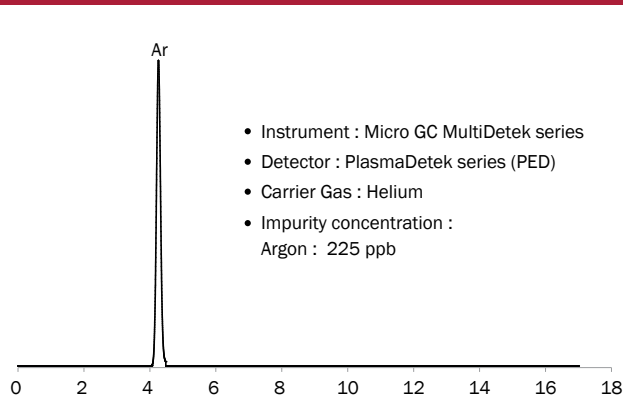

CHROMATOGRAM #16

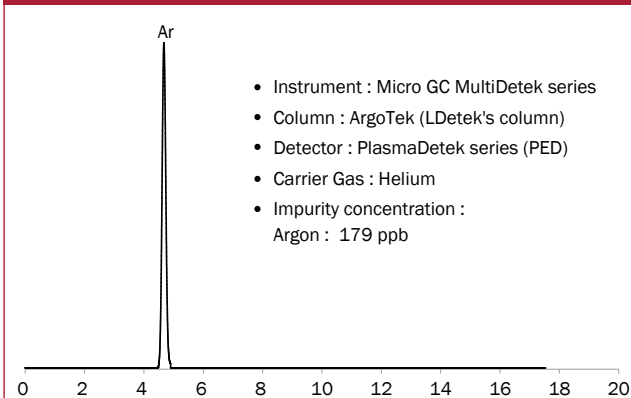

CHROMATOGRAM #17

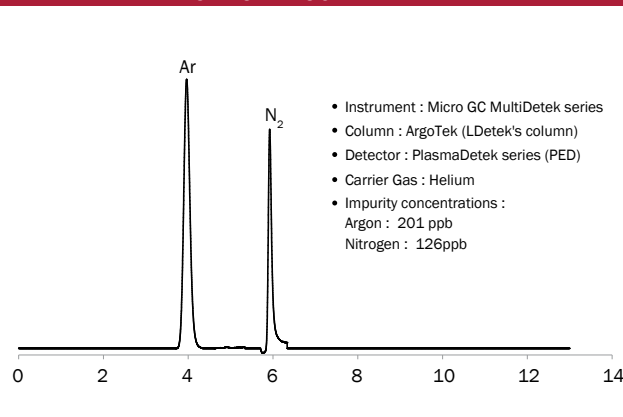

CHROMATOGRAM #19

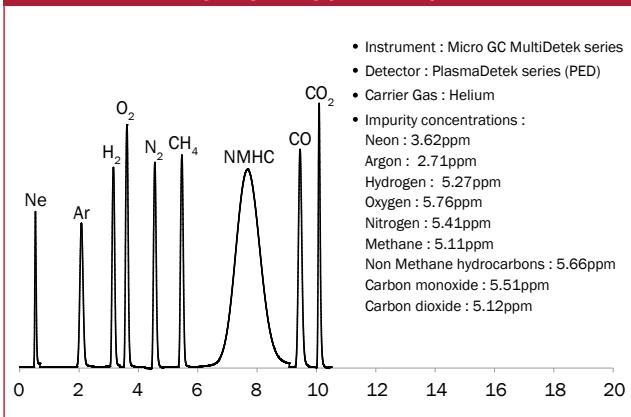

CHROMATOGRAM #23

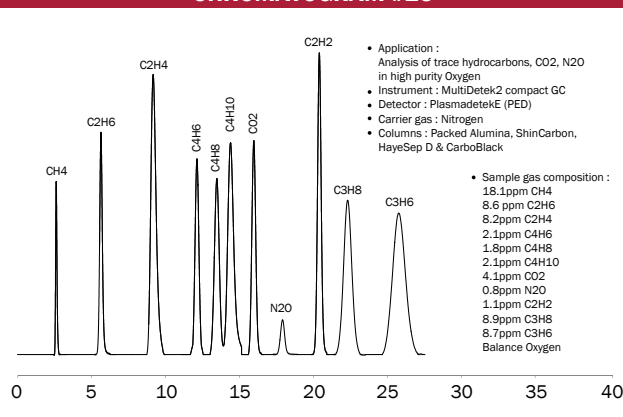

CHROMATOGRAM #25

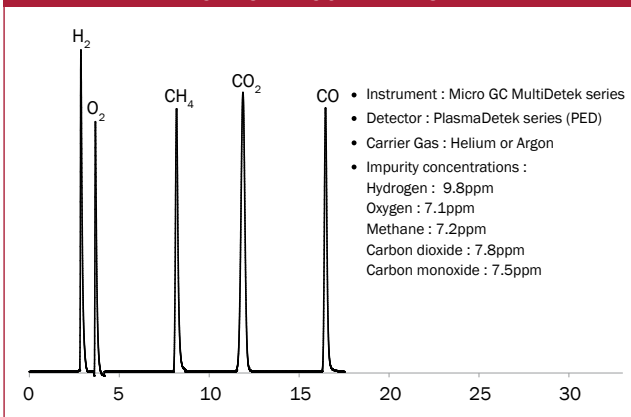

CHROMATOGRAM #30

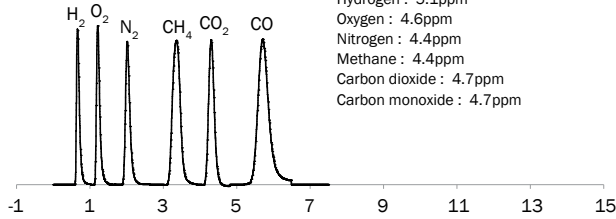

- Instrument : Micro GC MultiDetek series
- Detector : PlasmaDetek series (PED)
- Carrier Gas : Argon
- Impurity concentrations :
 Hydrogen : 5.1ppm
 Oxygen : 4.6ppm
 Nitrogen : 4.4ppm
 Methane : 4.4ppm
 Carbon dioxide : 4.7ppm
 Carbon monoxide : 4.7ppm

CHROMATOGRAM #31

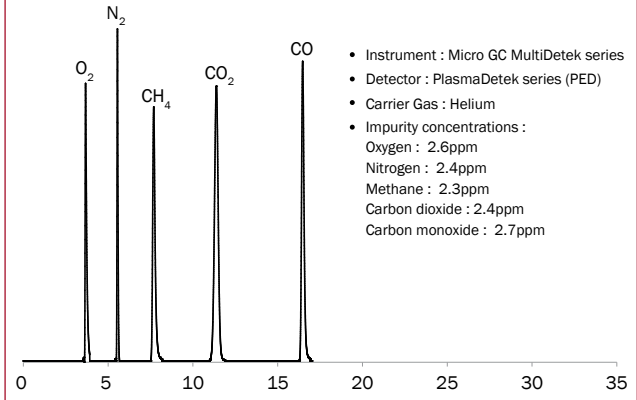

- Instrument : Micro GC MultiDetek series
- Detector : PlasmaDetek series (PED)
- Carrier Gas : Helium
- Impurity concentrations :
 Oxygen : 2.6ppm
 Nitrogen : 2.4ppm
 Methane : 2.3ppm
 Carbon dioxide : 2.4ppm
 Carbon monoxide : 2.7ppm

CHROMATOGRAM #32

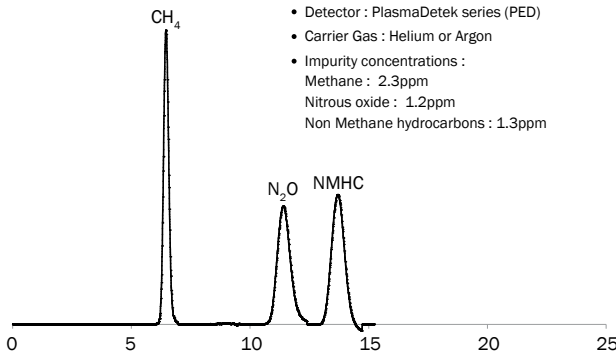

- Instrument : Micro GC MultiDetek series
- Detector : PlasmaDetek series (PED)
- Carrier Gas : Helium or Argon
- Impurity concentrations :
 Methane : 2.3ppm
 Nitrous oxide : 1.2ppm
 Non Methane hydrocarbons : 1.3ppm

CHROMATOGRAM #33

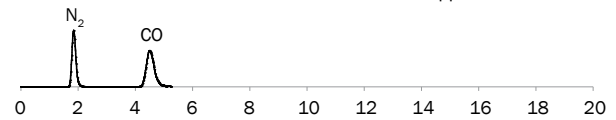

- Instrument : Micro GC MultiDetek series
- Detector : PlasmaDetek series (PED)
- Carrier Gas : Argon
- Impurity concentrations :
 Nitrogen : 0.9ppm
 Carbon monoxide : 0.7ppm

CHROMATOGRAM #34

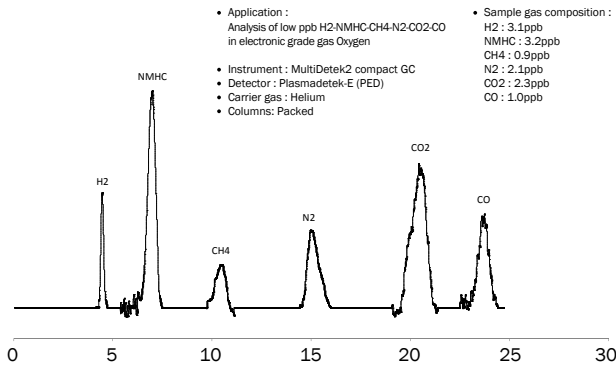

- Application :
 Analysis of low ppb H2-NMHC-CH4-N2-CO2-CO
 in electronic grade gas Oxygen
- Instrument : MultiDetek2 compact GC
- Detector : Plasmadetek-E (PED)
- Carrier gas : Helium
- Columns: Packed
- Sample gas composition :
 H2 : 3.1ppb
 NMHC : 3.2ppb
 CH4 : 0.9ppb
 N2 : 2.1ppb
 CO2 : 2.3ppb
 CO : 1.0ppb

CHROMATOGRAM #35

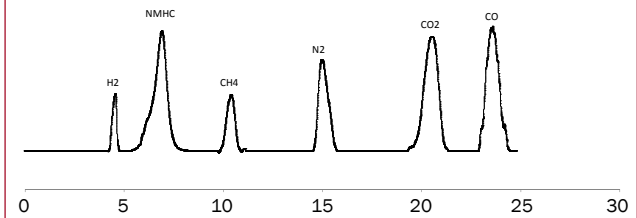

- Application :
 Analysis of low ppb H2-NMHC-CH4-N2-CO2-CO
 in electronic grade gas Oxygen
- Instrument : MultiDetek2 compact GC
- Detector : Plasmadetek-E (PED)
- Carrier gas : Helium
- Columns: Packed
- Sample gas composition :
 H2= 7.5ppb
 NMHC : 9.1ppb
 CH4= 6.1ppb
 N2= 7.2 ppb
 CO2 =5.9ppb
 CO= 4.1ppb

CHROMATOGRAM #36

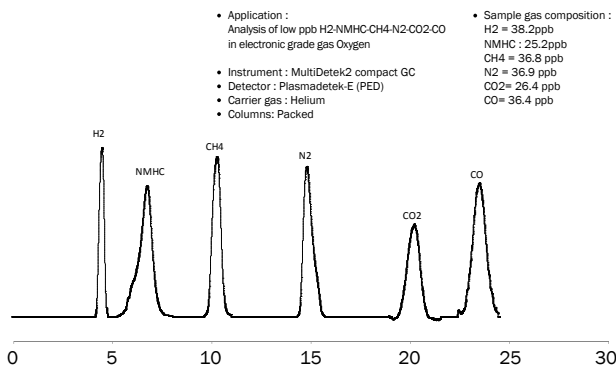

- Application :
 Analysis of low ppb H2-NMHC-CH4-N2-CO2-CO
 in electronic grade gas Oxygen
- Instrument : MultiDetek2 compact GC
- Detector : Plasmadetek-E (PED)
- Carrier gas : Helium
- Columns: Packed
- Sample gas composition :
 H2 = 38.2ppb
 NMHC : 25.2ppb
 CH4 = 36.9 ppb
 N2 = 36.9 ppb
 CO2= 26.4 ppb
 CO= 36.4 ppb

CHROMATOGRAM #37

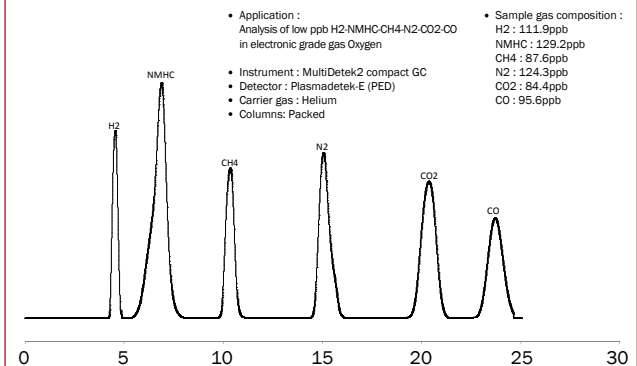

- Application :
 Analysis of low ppb H2-NMHC-CH4-N2-CO2-CO
 in electronic grade gas Oxygen
- Instrument : MultiDetek2 compact GC
- Detector : Plasmadetek-E (PED)
- Carrier gas : Helium
- Columns: Packed
- Sample gas composition :
 H2 : 111.9ppb
 NMHC : 129.2ppb
 CH4 : 87.6ppb
 N2 : 124.3ppb
 CO2 : 84.4ppb
 CO : 95.6ppb

CHROMATOGRAM #38

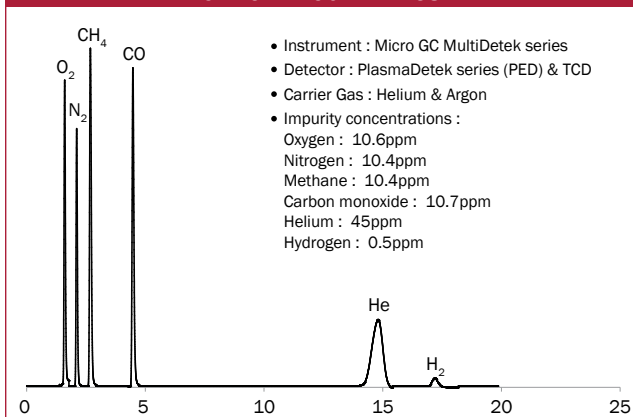

CHROMATOGRAM #39

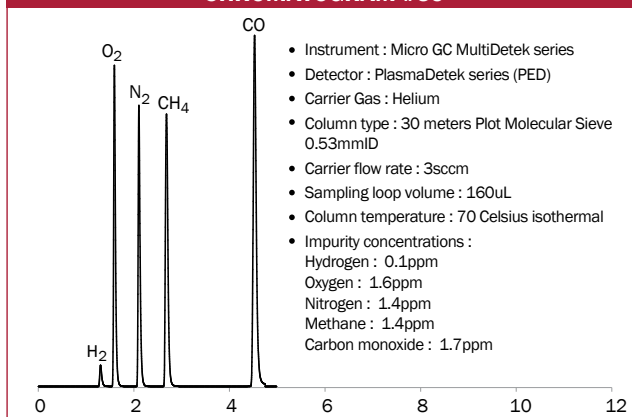

CHROMATOGRAM #40

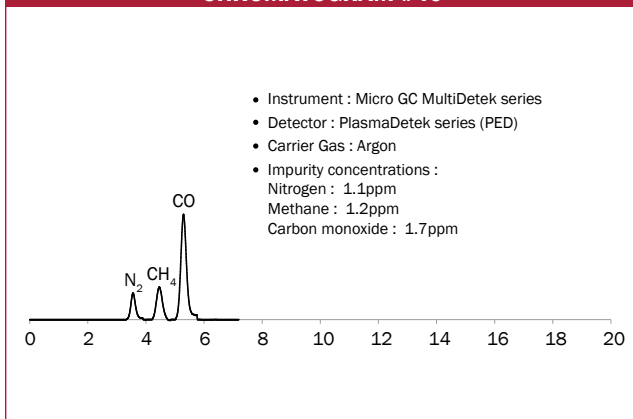

CHROMATOGRAM #41

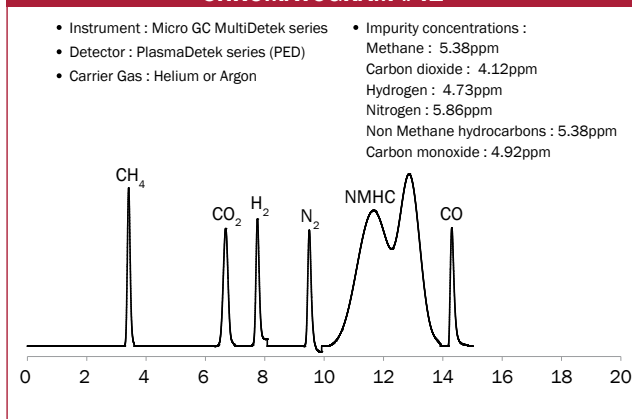

CHROMATOGRAM #42

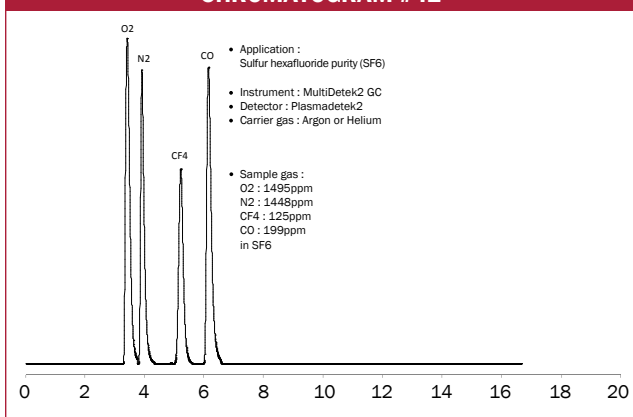

CHROMATOGRAM #43

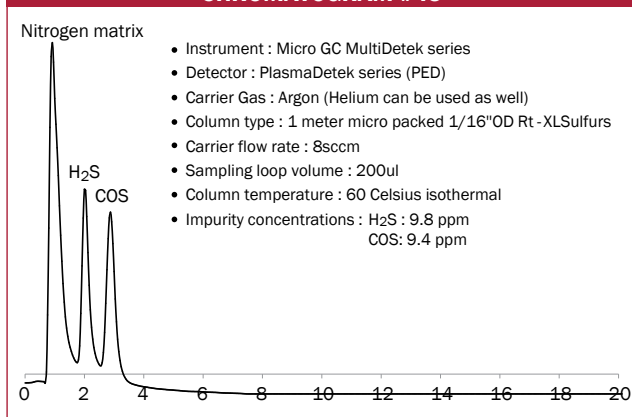

CHROMATOGRAM #44

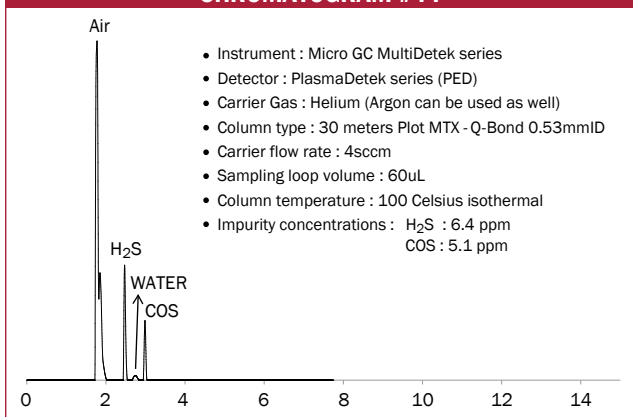

CHROMATOGRAM #45

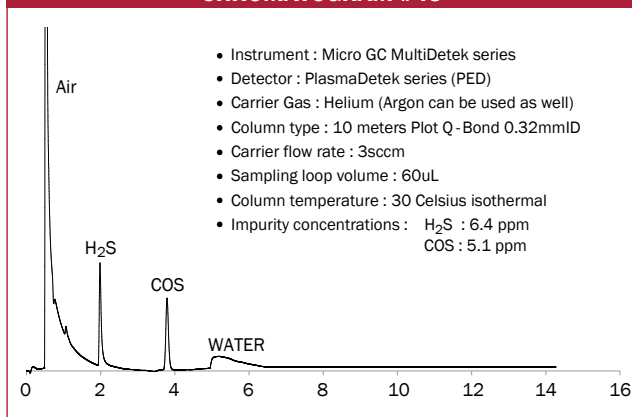

CHROMATOGRAM #46

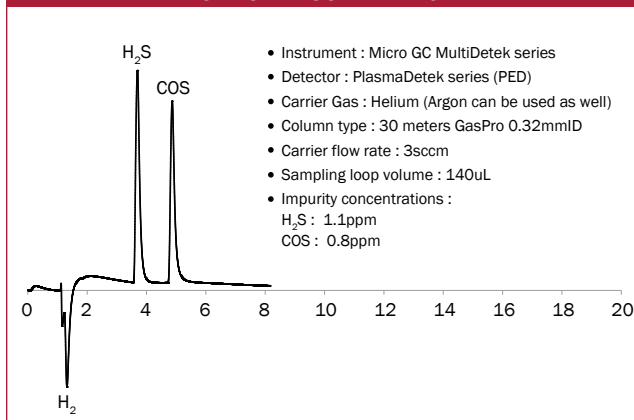

CHROMATOGRAM #48

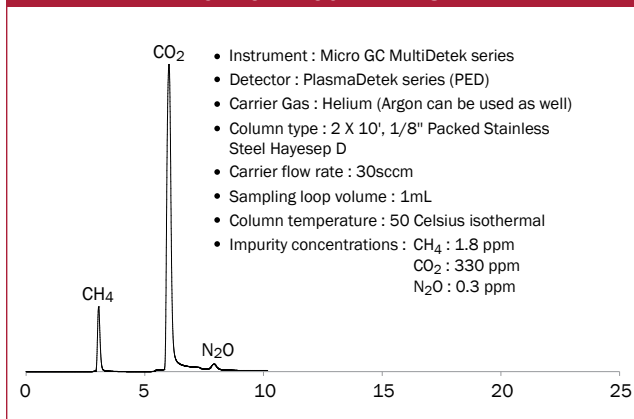

CHROMATOGRAM #49

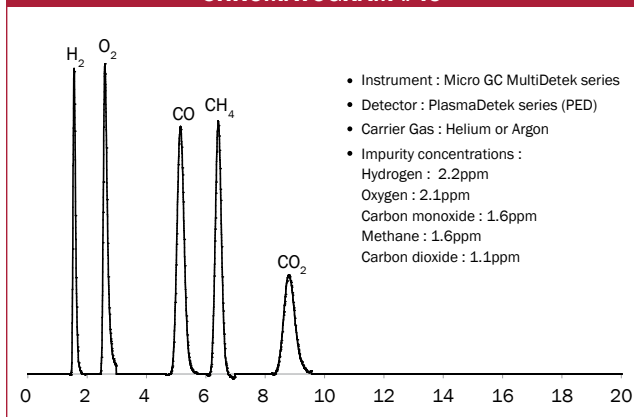

CHROMATOGRAM #51

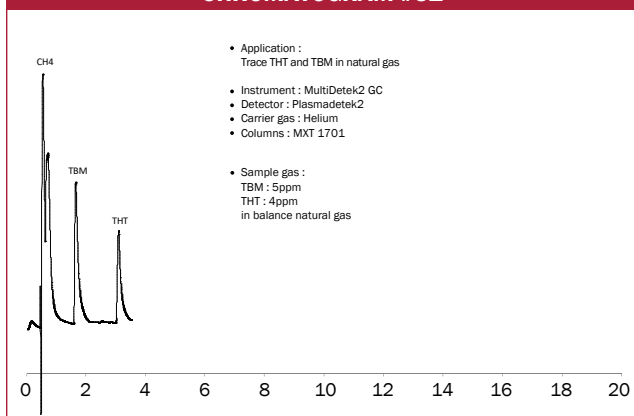

CHROMATOGRAM #47

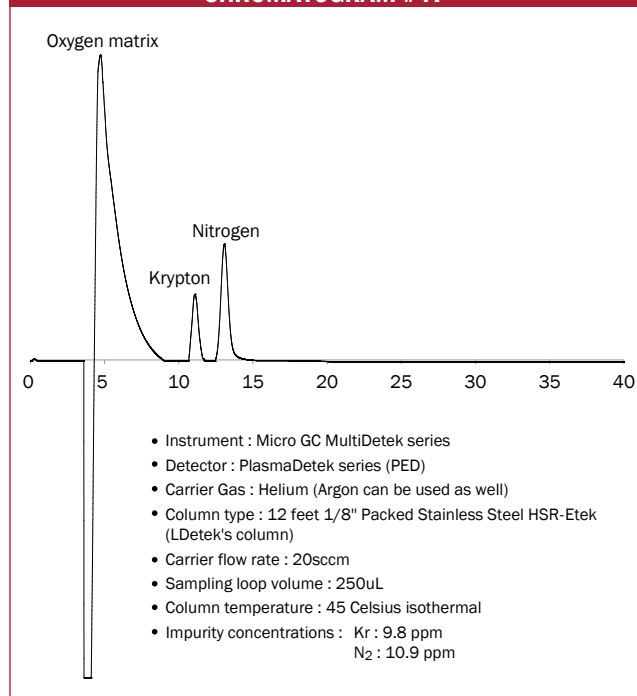

CHROMATOGRAM #50

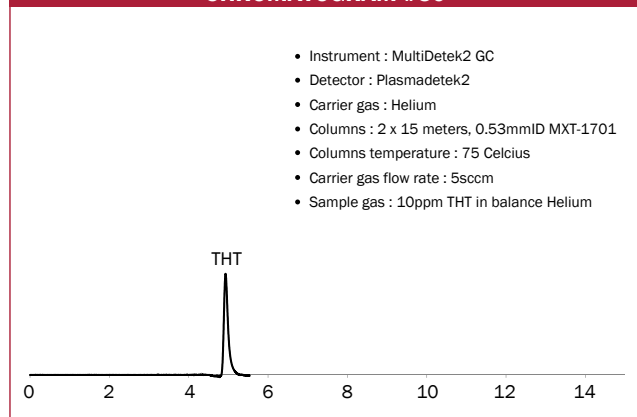

CHROMATOGRAM #52

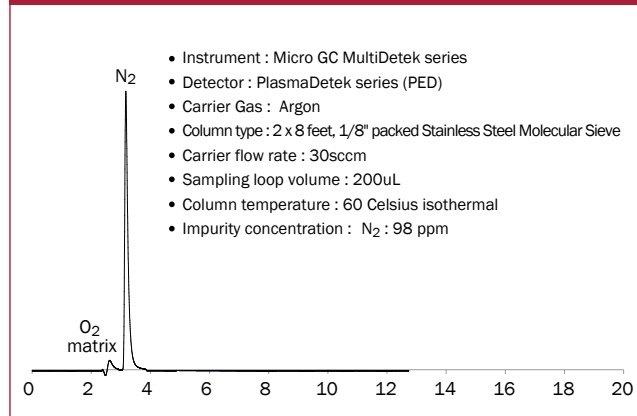

CHROMATOGRAM #53

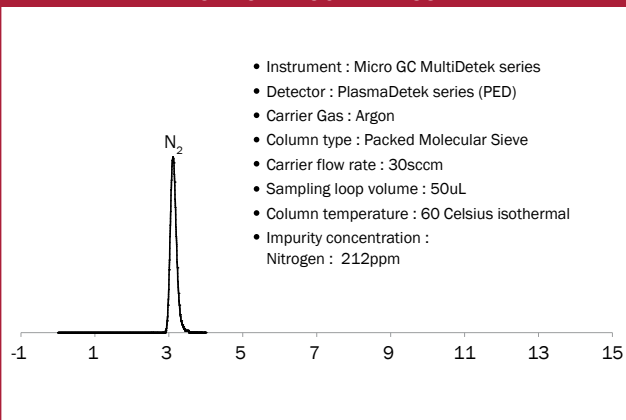

CHROMATOGRAM #54

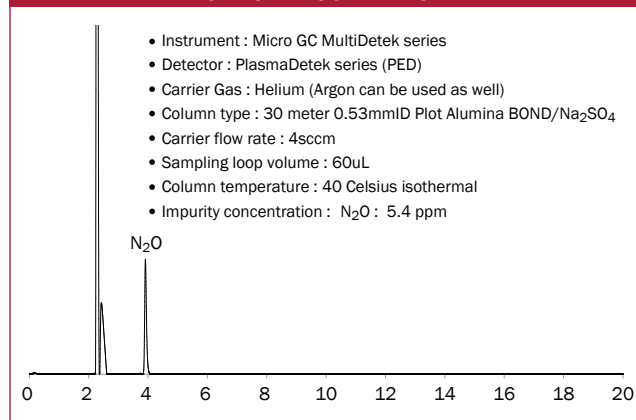

CHROMATOGRAM #56

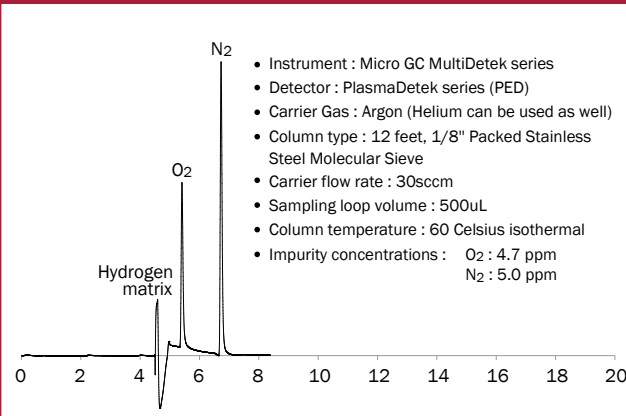

CHROMATOGRAM #57

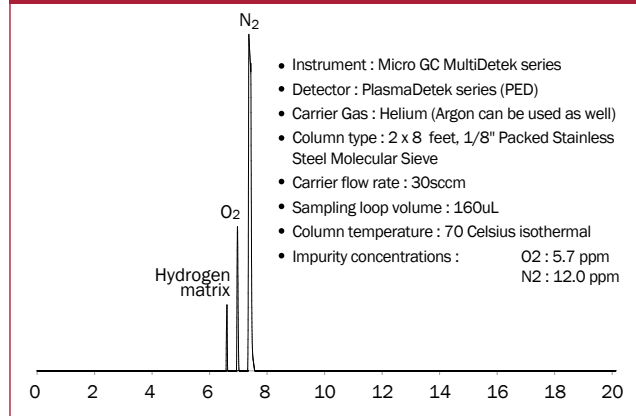

CHROMATOGRAM #58

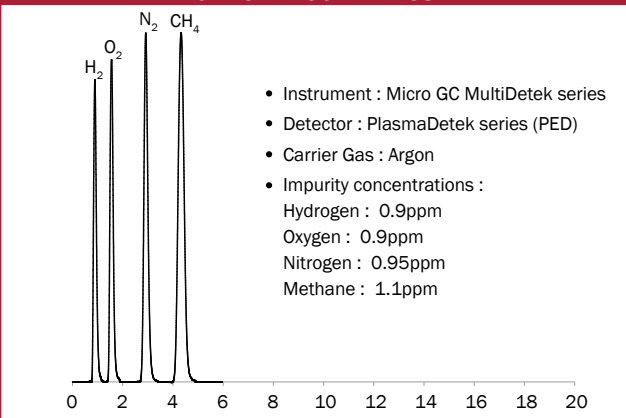

CHROMATOGRAM #62

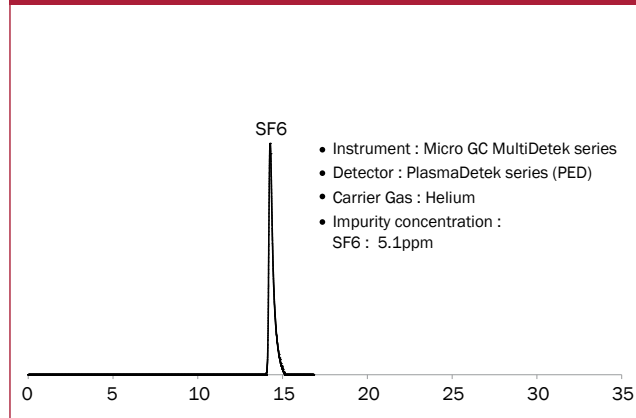

CHROMATOGRAM #63

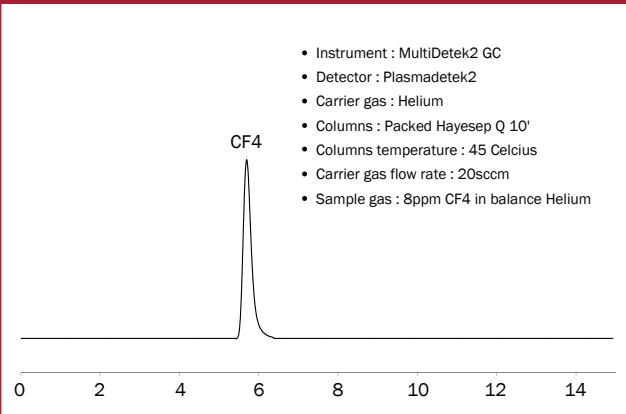

CHROMATOGRAM #66

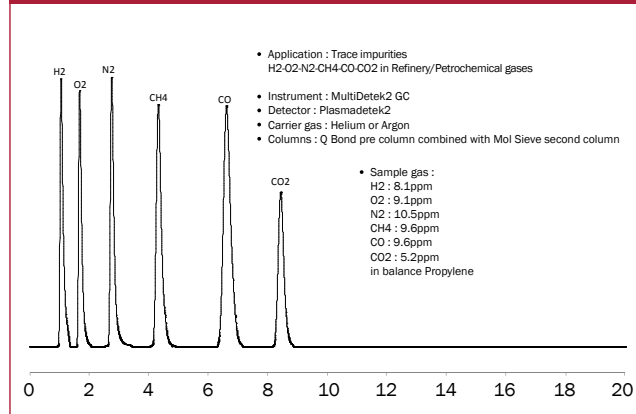

CHROMATOGRAM #67

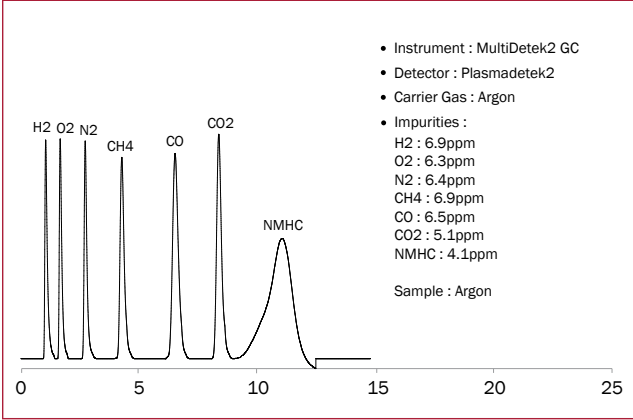

CHROMATOGRAM #68

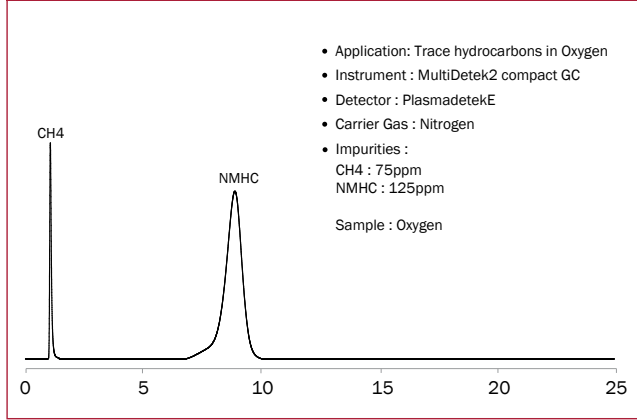

CHROMATOGRAM #69

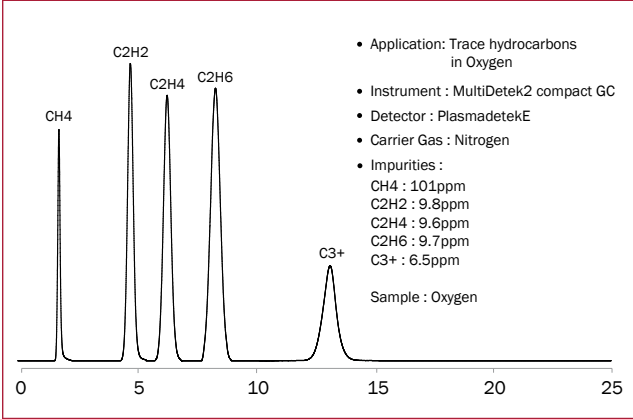

CHROMATOGRAM #71

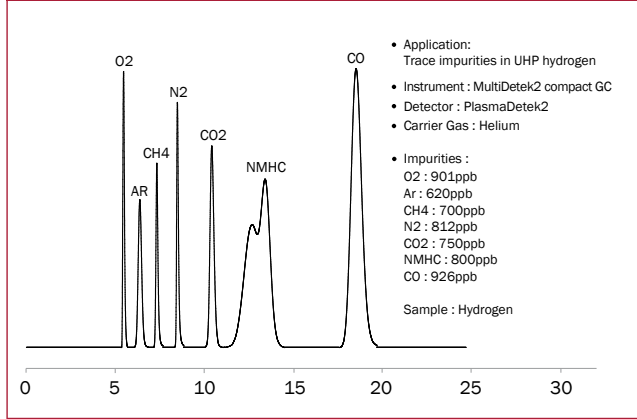

CHROMATOGRAM #72

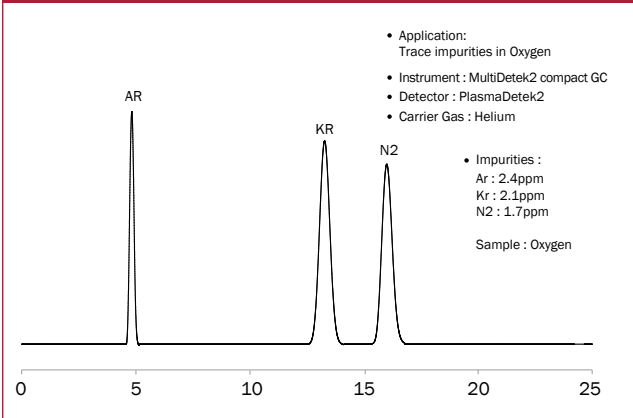

CHROMATOGRAM #73

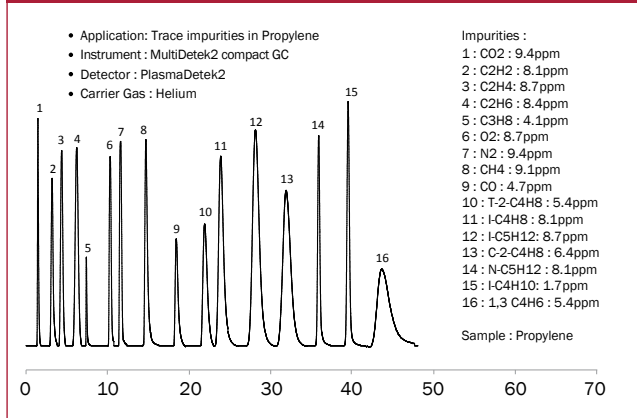

CHROMATOGRAM #74

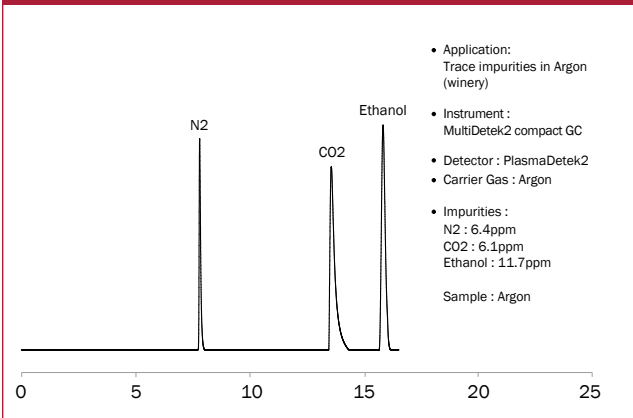

CHROMATOGRAM #75

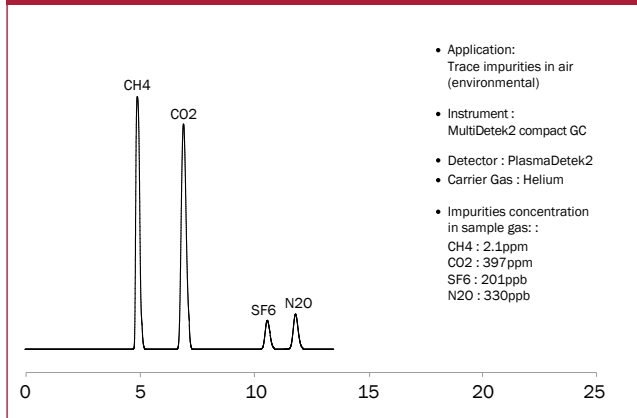

CHROMATOGRAM #76

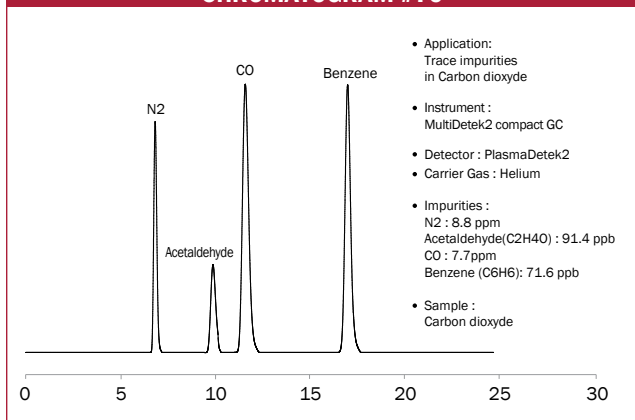

CHROMATOGRAM #78

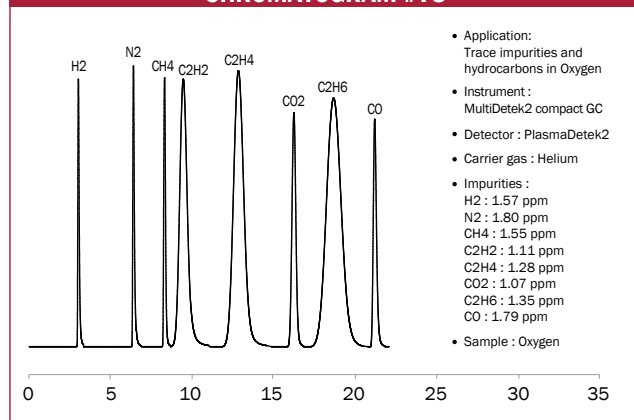

CHROMATOGRAM #79

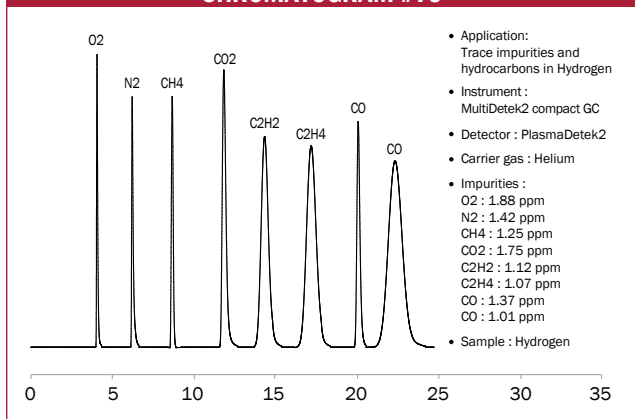

CHROMATOGRAM #80

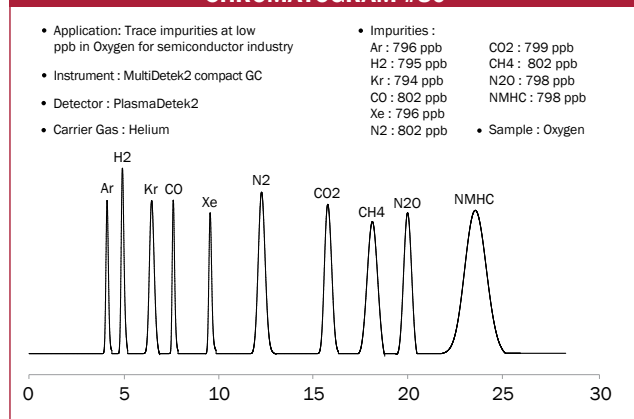

CHROMATOGRAM #81

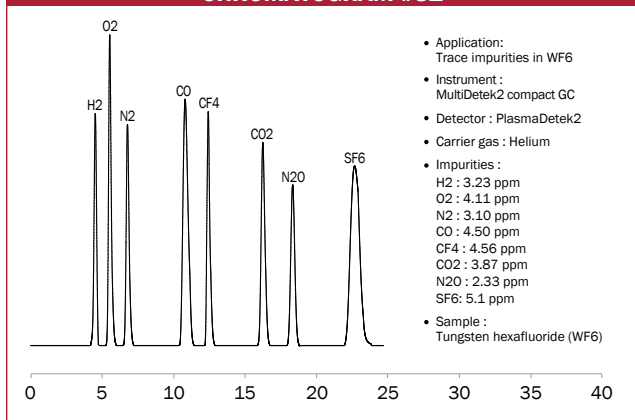

CHROMATOGRAM #82

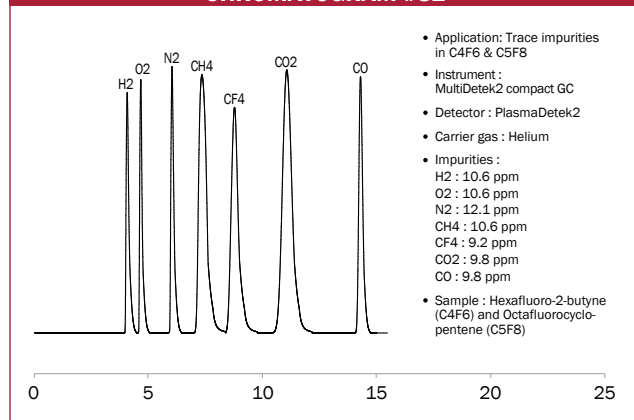

CHROMATOGRAM #83

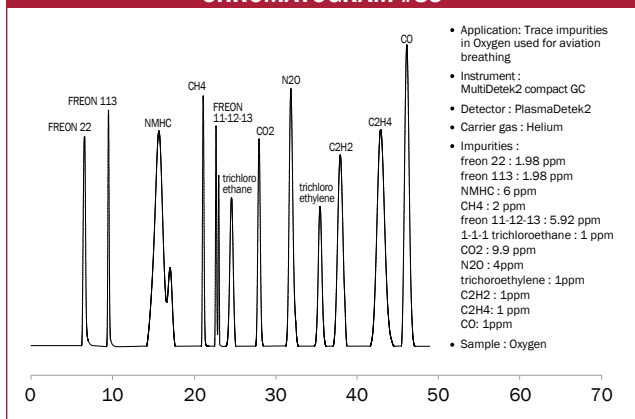

CHROMATOGRAM #84

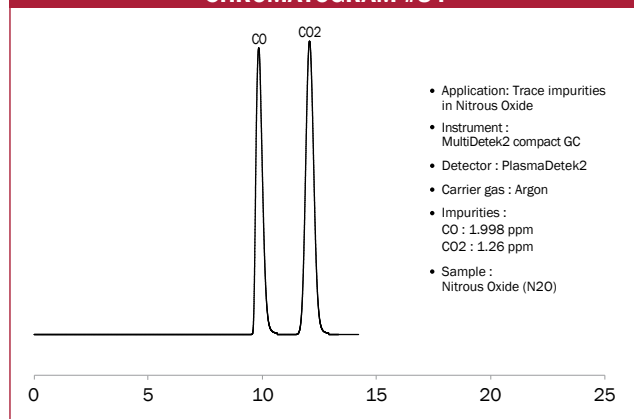

CHROMATOGRAM #85

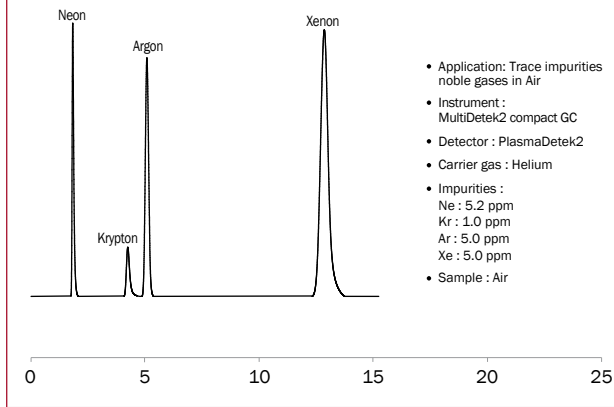

CHROMATOGRAM #86

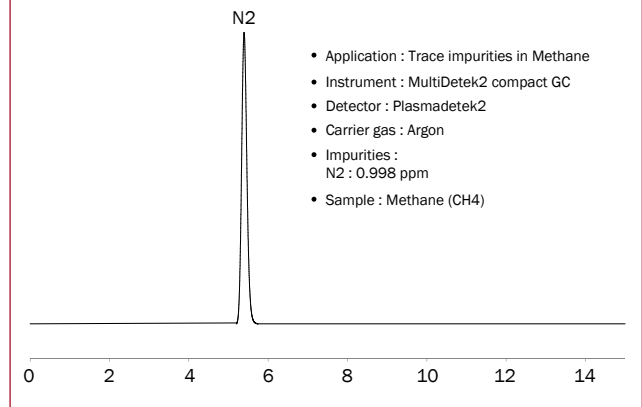

CHROMATOGRAM #87

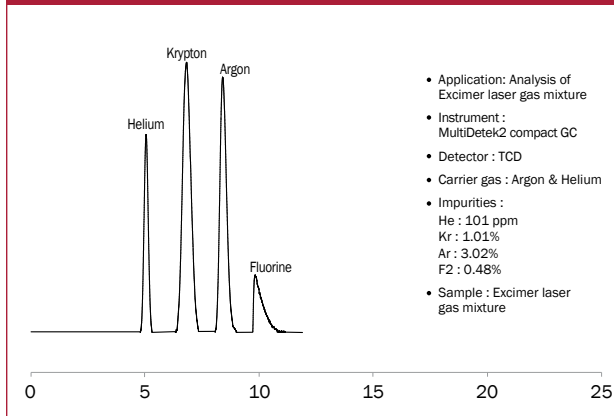

CHROMATOGRAM #88

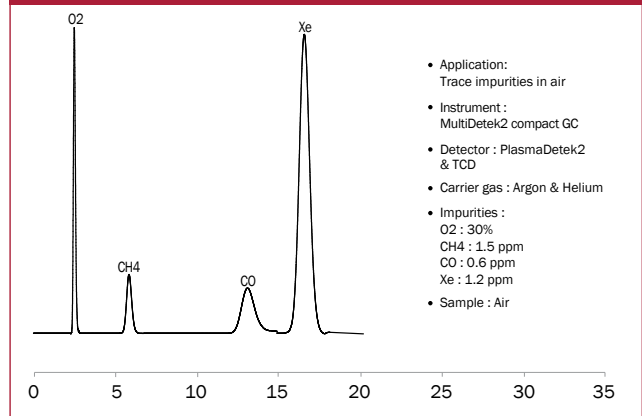

CHROMATOGRAM #89

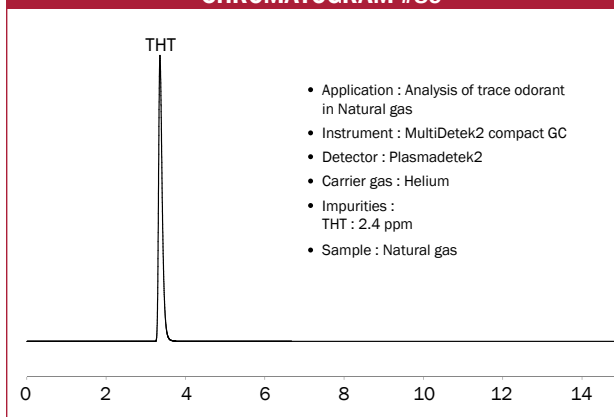

CHROMATOGRAM #90

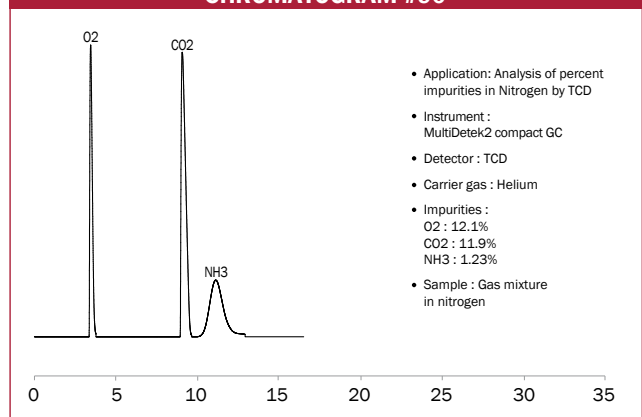

CHROMATOGRAM #91

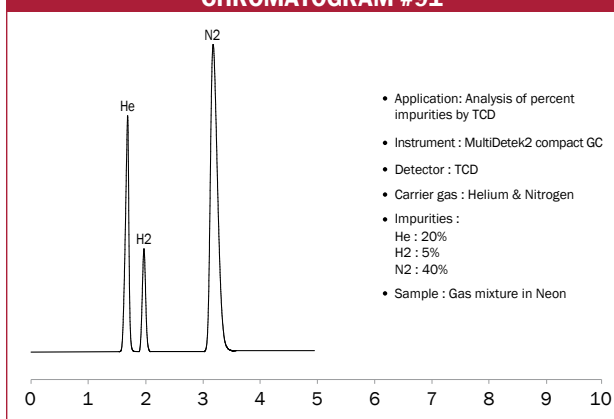

CHROMATOGRAM #92

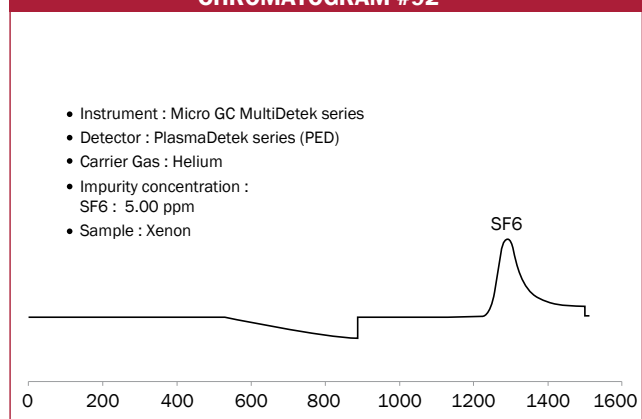

CHROMATOGRAM #93

- Instrument : Micro GC MultiDetek series
- Detector : PlasmaDetek series (PED)
- Carrier Gas : Helium
- Impurity concentration :
NMHC : 5.00 ppm
- Sample : Xenon

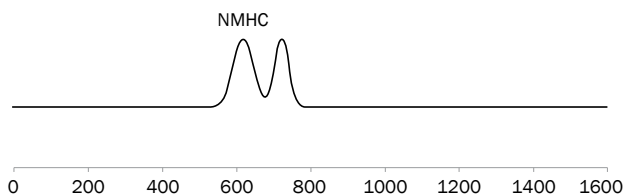

CHROMATOGRAM #94

- Instrument : Micro GC MultiDetek series
- Detector : PlasmaDetek series (PED)
- Carrier Gas : Helium
- Impurity concentration :
N2 : 5.00 ppm
- Sample : Xenon

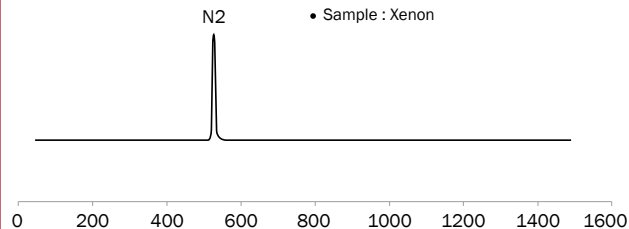

CHROMATOGRAM #95

- Instrument : Micro GC MultiDetek series
- Detector : PlasmaDetek series (PED)
- Carrier Gas : Helium
- Impurity concentration :
H2 : 5.00 ppm
O2 : 5.00 ppm
CH4 : 5.00 ppm
- Sample : Xenon

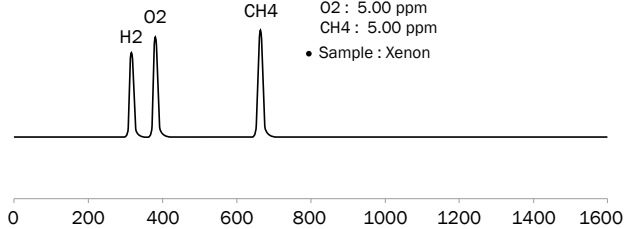

CHROMATOGRAM #96

- Instrument : Micro GC MultiDetek series
- Detector : PlasmaDetek series (PED)
- Carrier Gas : Helium
- Impurity concentration :
CO : 5.00 ppm
CO2 : 5.00 ppm
- Sample : Xenon

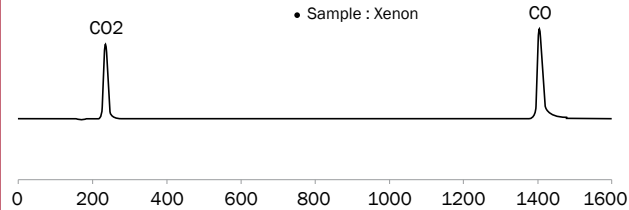

CHROMATOGRAM #97

- Instrument : Micro GC MultiDetek series
- Detector : PlasmaDetek series (PED)
- Carrier Gas : Helium
- Impurity concentration :
AR : 5.00 ppm
- Sample : Xenon

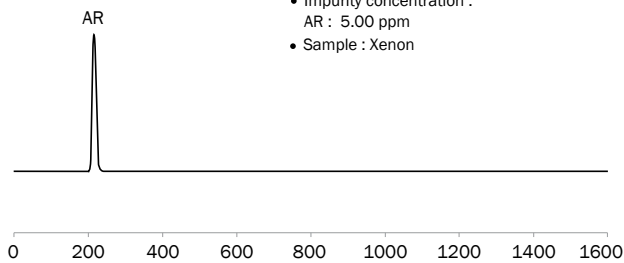

CHROMATOGRAM #98

- Instrument : Micro GC MultiDetek series
- Detector : PlasmaDetek series (PED)
- Carrier Gas : Helium
- Impurity concentration :
CF4 : 5.00 ppm
- Sample : Xenon

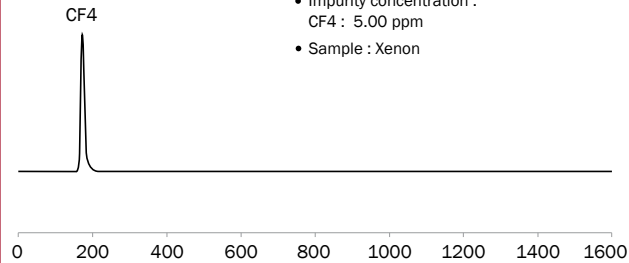

CHROMATOGRAM #99

- Instrument : Micro GC MultiDetek series
- Detector : PlasmaDetek series (PED)
- Carrier Gas : Helium
- Impurity concentration :
CF4 : 5.00 ppm
- Sample : Krypton

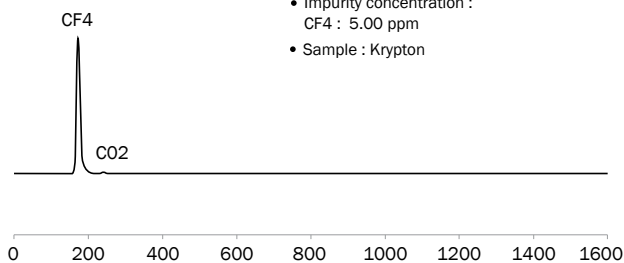

CHROMATOGRAM #100

- Instrument : Micro GC MultiDetek series
- Detector : PlasmaDetek series (PED)
- Carrier Gas : Helium
- Impurity concentration :
CO : 5.00 ppm
CO2 : 5.00 ppm
- Sample : Krypton

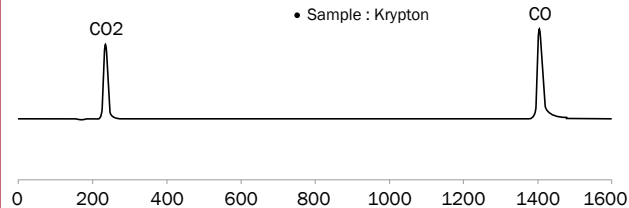

CHROMATOGRAM #101

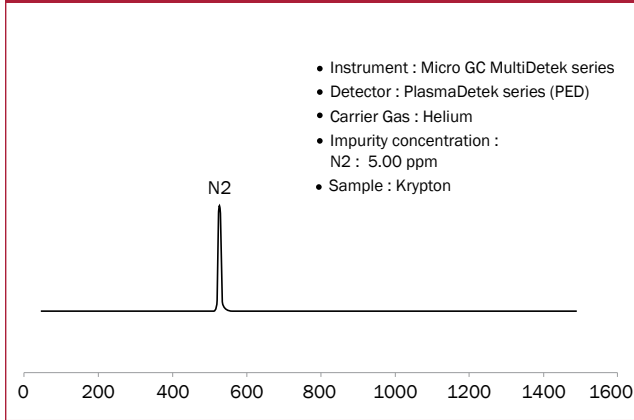

CHROMATOGRAM #102

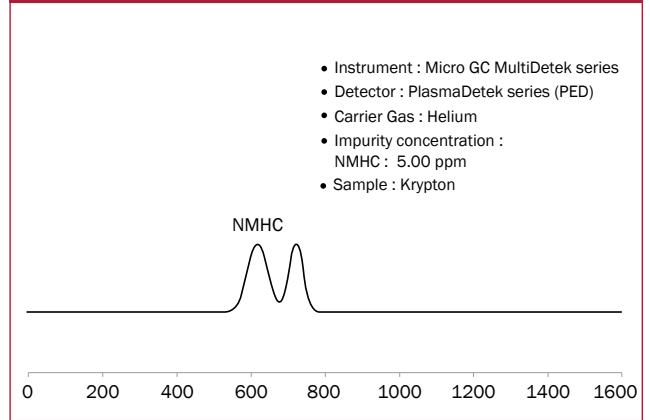

CHROMATOGRAM #103

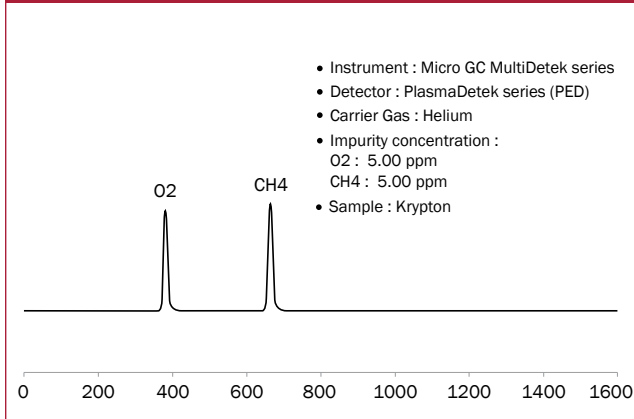

CHROMATOGRAM #104

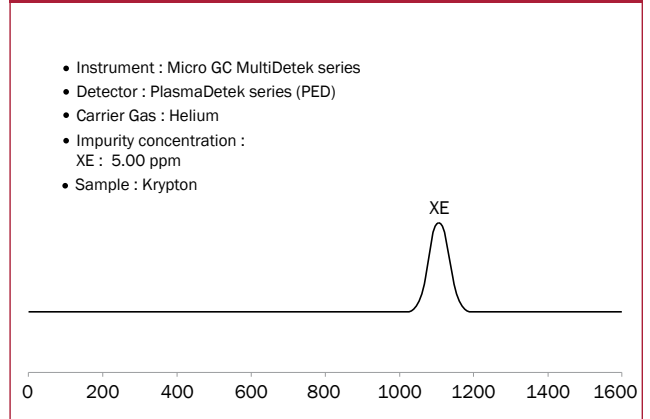

CHROMATOGRAM #105

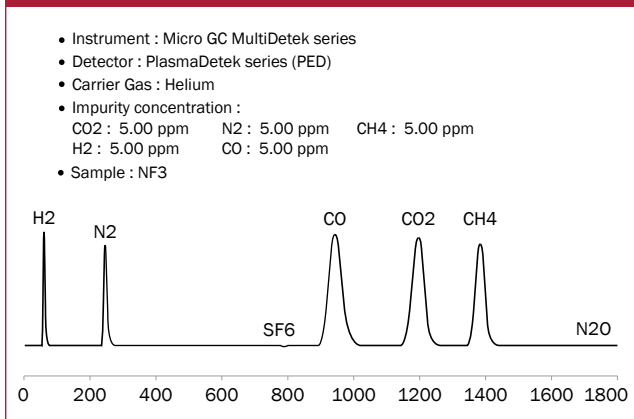

CHROMATOGRAM #106

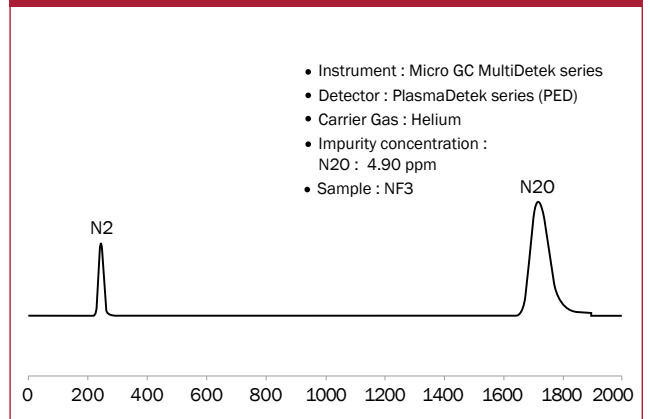

CHROMATOGRAM #107

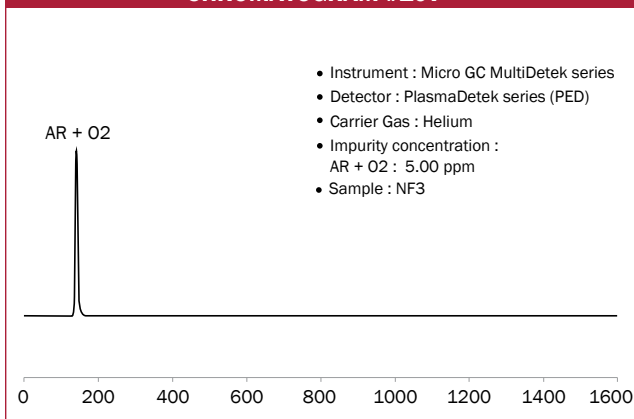

CHROMATOGRAM #108

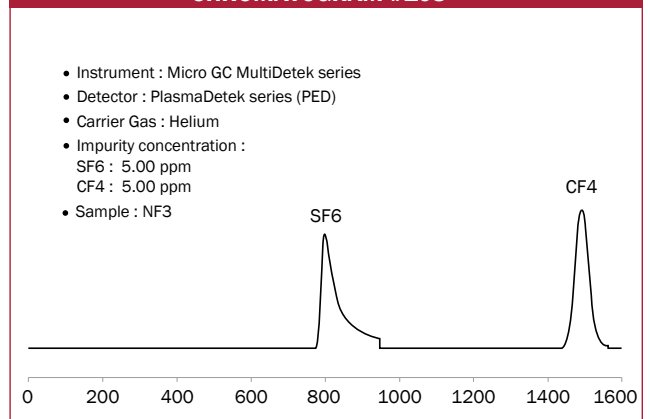

CHROMATOGRAM #109

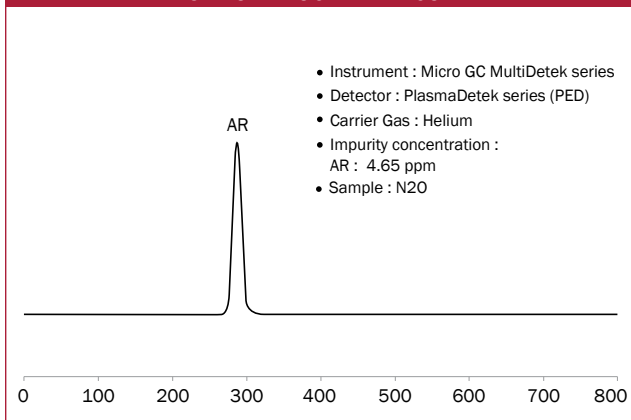

CHROMATOGRAM #110

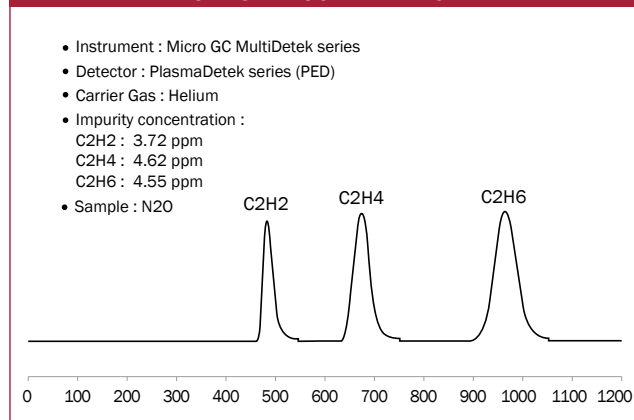

CHROMATOGRAM #111

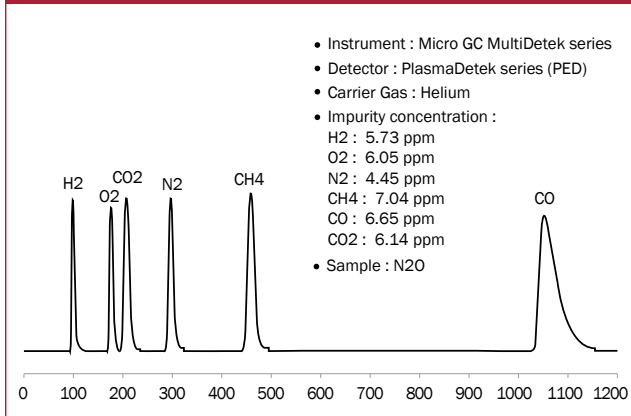

CHROMATOGRAM #112

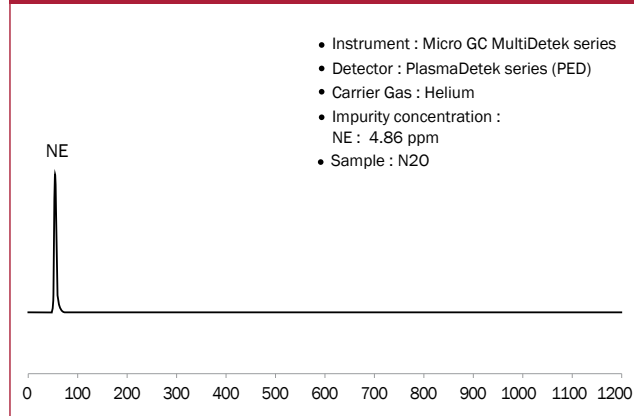

CHROMATOGRAM #113

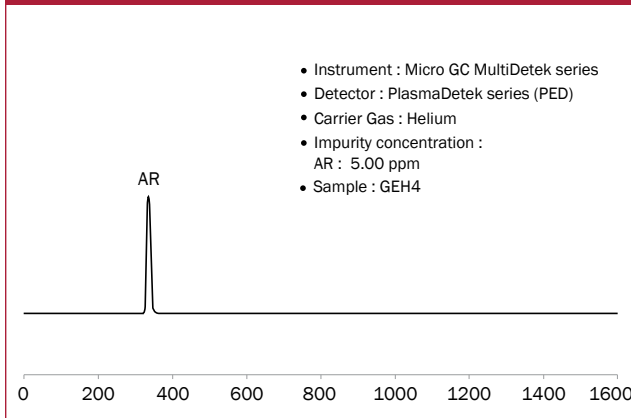

CHROMATOGRAM #114

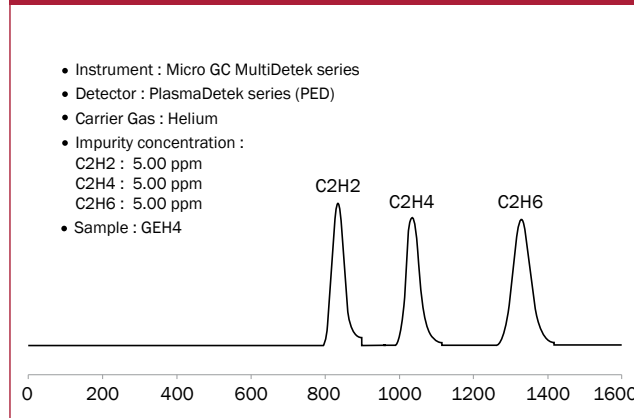

CHROMATOGRAM #115

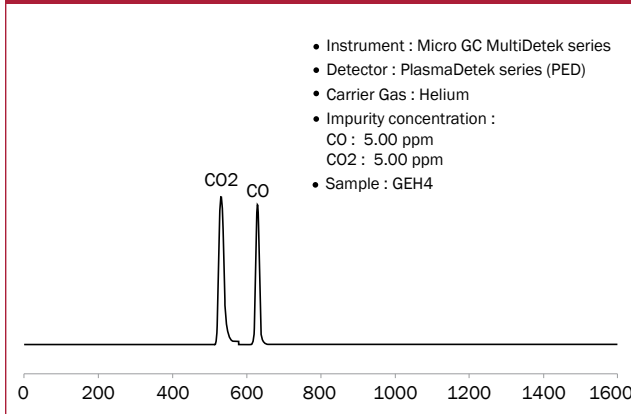

CHROMATOGRAM #116

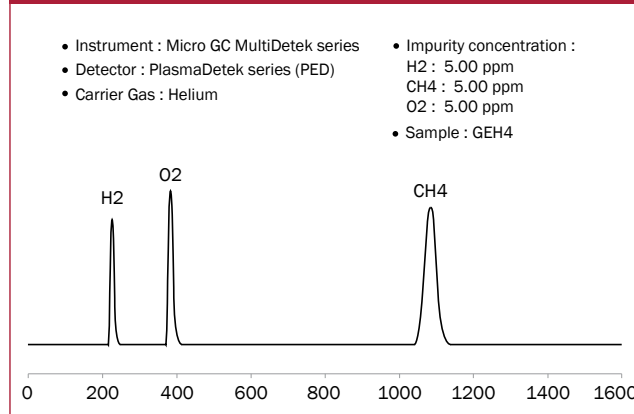

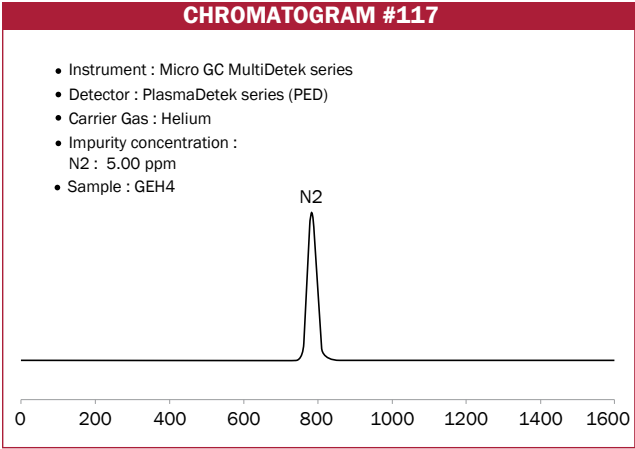



Where **innovation** leads to **success**

990 Monfette Est, Thetford Mines, (Qc), Canada, G6G 7K6
Phone: 418 755-1319 • Fax: 418 755-1329
info@ldetek.com • www.ldetek.com